

Manual

ez-Converter

ez-hs+ (HDMI/VGA To 3G/HD/SD-SDI Converter with Scaler)

**ez Converter** **Scaler**  
Up/Down Scaler



Model : ez-hs+

## ez-hs+ Manual

Revision Number: **1.0.1**

Distribution Date: **January, 2016**

### Copy Rights

Copyright © 2006~2015 LUMANTEK Co., Ltd.

All Rights Reserved

This document contains information that is proprietary to LUMANTEK.CO., LTD. The information in this document is believed to be accurate and reliable; however, LUMANTEK assumes no responsibility or liability for any errors or inaccuracies that may appear in this document, nor for any infringements of patents or other rights to third parties resulting from its use.

This publication may contain technical issues, inaccurate information or typos. These will be revised in revised edition, if there is any. No part of this publication is subject to be reproduced, stored in retrieval system, or transmitted in any forms, or any means without the prior consent by Lumantek.

### Trademarks

HD ENCODULATOR™, SD ENCODULATOR™ LUMANTEK Logo, Mega Cruiser™, ORIX™, X-Cruiser™, DTA-Plus™, Media Blaster™, are Trademarks of Lumantek. Co., Ltd.

Any other trademarks than stated above in this document belongs to its pertinent corporation.

### Warranty Period

Lumantek's products comes with One(1) year limited warranty. Please contact below if you need more information.

LUMANTEK CUSTOMER SERVICES

[sales@lumantek.co.kr](mailto:sales@lumantek.co.kr) / TEL:02-6947-7400 / FAX:02-6947-7440

## Contents

1. Introduction -----	4
2. ez-hs+ interface -----	5
2.1 system information	5
2.2 Package contents	5
2.3 DIP Switch configuration	6
2.4 System specification	7
3. System flow diagram -----	7

## ez-hs+ (HDMI/VGA To 3G/HD/SD-SDI Converter With Scaler)

HDMI and VGA to 3G/HD/SD-SDI signal conversion

### 1. Introduction

ez-hs+ is one of Lumantek's ezConverter series featuring HDMI,VGA to 3G/HD/SD-SDI signal conversion. Selectable system resolution allows designing a new broadcasting system with a specific resolution standard for HDMI and VGA Signals. User can use embedded audio for HDMI. For VGA, the external 3.5mm stereo audio port is used as a sound embedder. Aspect ratio is configurable at user's preference as well.

#### Features

- ① Selectable input between HDMI x1 and VGAX1 input
- ② External Audio embedder (3.5mm Stereo Input)
- ③ Selectable aspect ratio (Please see Dip Switch configuration on page 6)
- ④ HD –SDI x2 (same output) supporting long distance transmission
- ⑤ Selectable Resolutions (up/down scaler function)
- ⑥ PC Input signal compatible ( VESA Standard )

## 2. ez-hs+ Interface

### 2.1 System Information

< ez-hs+ Front >



< ez-hs+ Rear >

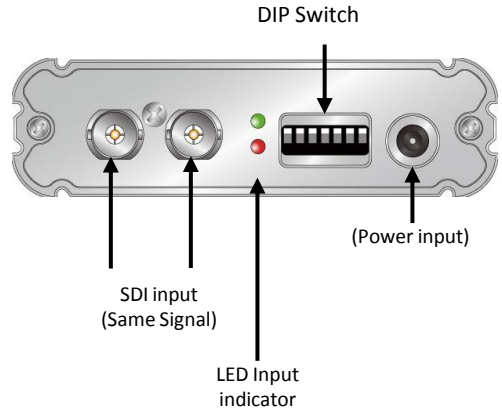
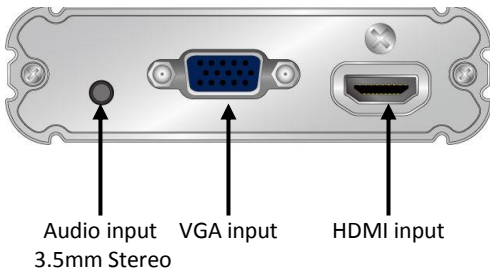

### 2.2 Package contents



ez-hs+



ez-as+ (Europe/South East Asia)  
Power Adaptor (DC 12V /1A)



ez-as+ (US/Japan)  
Power Adaptor (DC 12V /1A)



ez-hs+  
Mounting Brackets

### 2.3 DIP Switch configuration

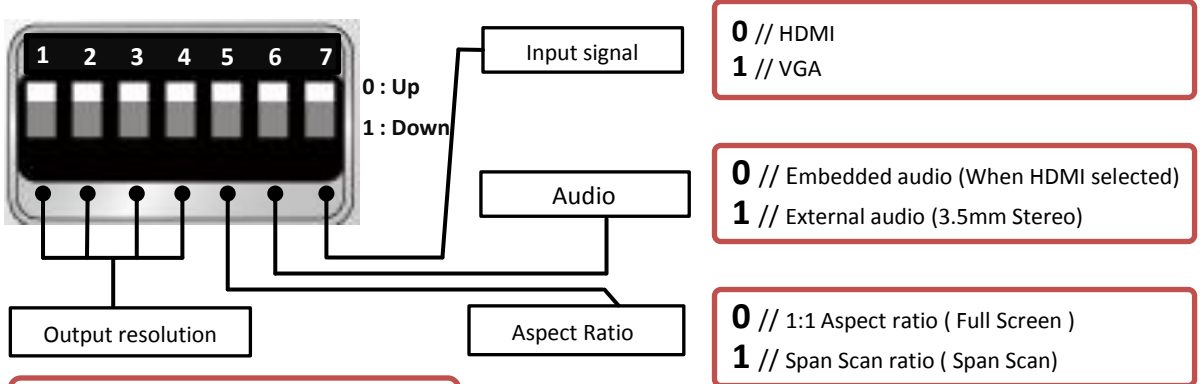

- **0000** //720x480i59.94
- **1000** //720x576i50
- **0100** //1280x720p50
- **1100** //1280x720p59.94
- **0010** //1280x720p60
- **1010** //1920x1080i50
- **0110** //1920x1080i59.94
- **1110** //1920x1080i60
- **0001** //1920x1080p23.98
- **1001** //1920x1080p24
- **0101** //1920x1080p25
- **1101** //1920x1080p29.97
- **0011** //1920x1080p30
- **1011** //1920x1080p50
- **0111** //1920x1080p59.94
- **1111** //1920x1080p60

### Span Scan

16:9 selected for SD (4:3) out

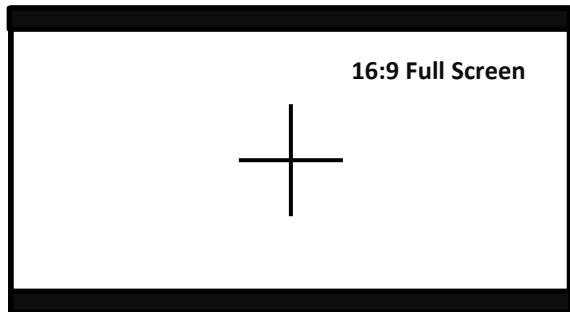

4:3 selected for HD(16:9) out

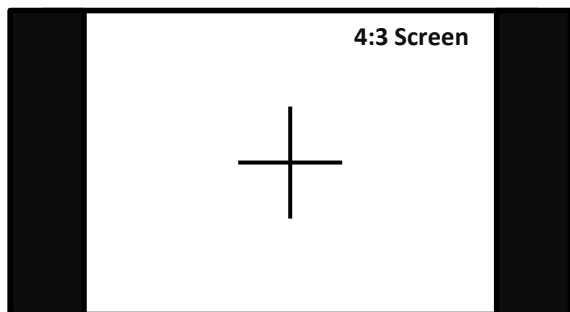

### 2.4 System Specification (ez-hs+ (HDMI/VGA to 3G/HS/SD-SDI Converter with Scaler))

Video Input Format	
VGA	HDMI
640x480	720x480i @59.94, 720x576i @50
800x600	1280x720p @50/59.94/60
1024x768	1920x1080i @50/59.94/60
1280x1024	1920x1080p @23.98/24/25
1600x1200	1920x1080p @29.97/30
1920x1080	1920x1080p @50/59.94/60
Video Output Format	
720x480i @59.94, 720x576i @50	
1280x720p @50/59.94/60	
1920x1080i @50/59.94/60	
1920x1080p @23.98/24/25/29.97/30	
1920x1080p @50/59.94/60	
Video Aspect Ratio	
Full / Letter Box	
Audio Input Connector : 3.5mm stereo Jack x1	
Video Input Connector : HDMI(Type A) x1, VGA x1	
Video Output Connector : BNC x2 (3G/HD/SD-SDI)	
DC Input Power : 5V~18V	
Power Consumption : < 3W	
Dimensions : 131 x 98.8 x 28.4 mm	

### 3. System flow diagram

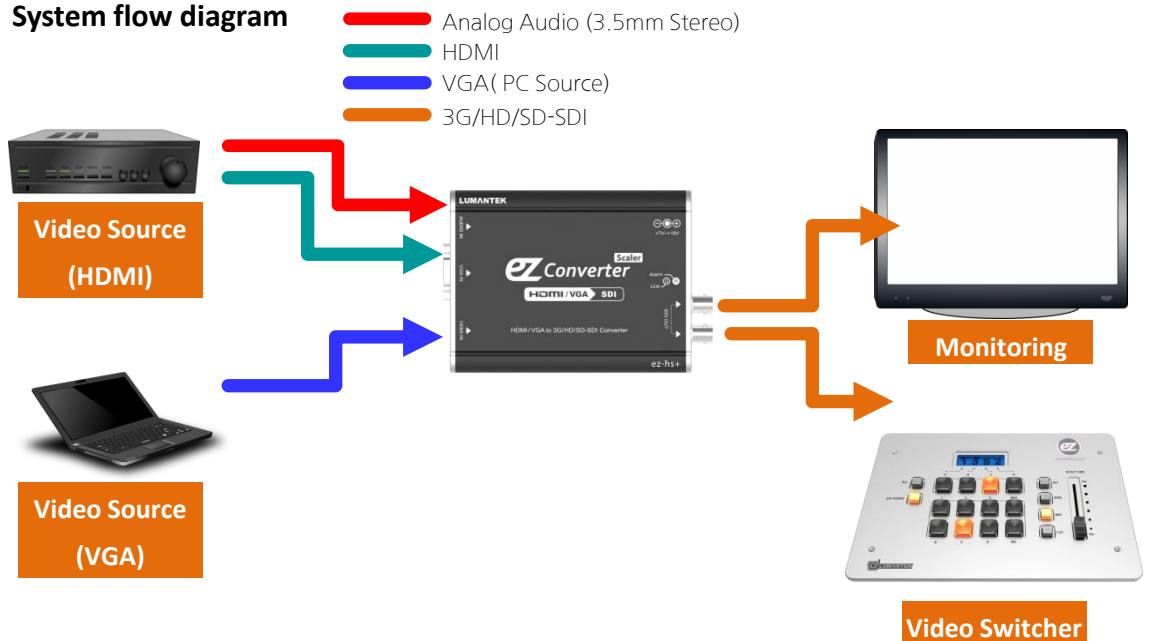

Manual

# ez Converter

## ez-as+ (CVBS to 3G/HD/SD-SDI Converter with Scaler)

# ez Converter **Scaler**

Up/Down Scaler





## ez-as+ Manual

Revision Number: 1.0.1

Distribution Date: January, 2016

### Copy Rights

Copyright © 2006~2015 LUMANTEK Co., Ltd.

All Rights Reserved

This document contains information that is proprietary to LUMANTEK.CO., LTD. The information in this document is believed to be accurate and reliable; however, LUMANTEK assumes no responsibility or liability for any errors or inaccuracies that may appear in this document, nor for any infringements of patents or other rights to third parties resulting from its use.

This publication may contain technical issues, inaccurate information or typos. These will be revised in revised edition, if there is any. No part of this publication is subject to be reproduced, stored in retrieval system, or transmitted in any forms, or any means without the prior consent by Lumantek.

### Trademarks

HD ENCODULATOR™, SD ENCODULATOR™ LUMANTEK Logo, Mega Cruiser™, ORIX™, X-Cruiser™, DTA-Plus™, Media Blaster™, are Trademarks of Lumantek. Co., Ltd.

Any other trademarks than stated above in this document belongs to its pertinent corporation.

### Warranty Period

Lumantek's products comes with One(1) year limited warranty. Please contact below if you need more information.

LUMANTEK CUSTOMER SERVICE

[sales@lumantek.co.kr](mailto:sales@lumantek.co.kr) / TEL:+82-2-6947-7400 / FAX:+82-2-6947-7440

[rma@lumantek.com](mailto:rma@lumantek.com) / TEL:+82-2-6947-7421

## Contents

1. Introduction -----	4
2. ez-as+ interface -----	5
2.1 system information	5
2.2 Package contents	5
2.3 DIP Switch configuration	6
2.4 System specification	7
3. System flow diagram -----	7

## ez-as+ (CVBS To 3G/HD/SD-SDI Converter With Scaler)

CVBS to 3G/HD/SD-SDI signal conversion

### 1. Introduction

ez-as+ is one of Lumantek's ezConverter series featuring CVBS/Analog to 3G/HD/SD-SDI signal conversion. Selectable system resolution allows designing a new broadcasting system with a specific resolution standard for HDMI and VGA Signals. User can use CVBS with the external 6.5mm (1/4") stereo audio port for a sound embedder. Aspect ratio is configurable at user's preference as well.

#### Features

- ① Converting from CVBS to 3G/HD/SD-SDI
- ② External Audio embedder (6.35mm Phone Jack balanced audio Input)
- ③ Selectable aspect ratio (Please see Dip Switch configuration on page 6)
- ④ HD-SDI x2 (same output) supporting long distance transmission
- ⑤ Selectable Resolutions (up/down scaler function)

## 2. ez-as+ Interface

### 2.1 System Information

< ez-as+ Front >



< ez-as+ Rear >



Audio input 3.5mm Stereo      CVBS input



Power      DIP Switch      LED Input indicator      SDI output

### 2.2 Package contents



ez-as+ main unit



ez-as+ (Europe/South East Asia)  
Power Adaptor (DC 12V /1A)



ez-as+ (US/Japan)  
Power Adaptor (DC 12V /1A)



ez-as+  
Mounting Brackets

### 2.3 DIP Switch configuration

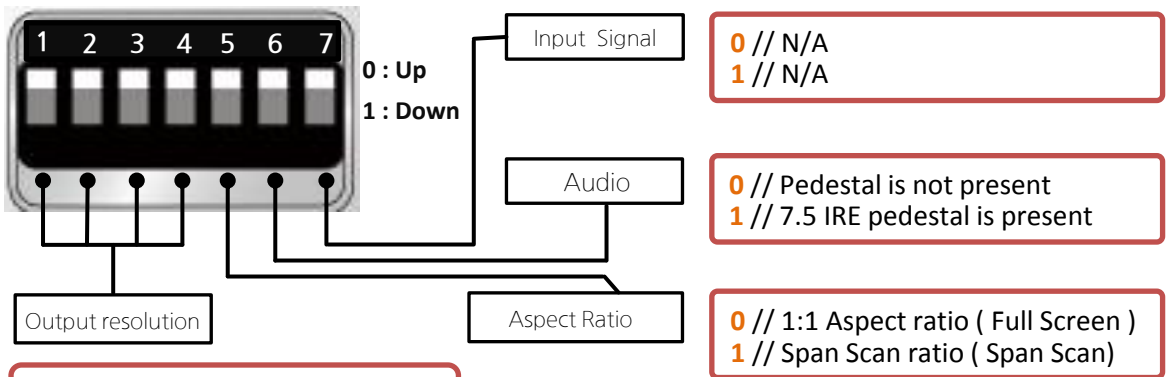

- **0000** //720x480i59.94
- **1000** //720x576i50
- **0100** //1280x720p50
- **1100** //1280x720p59.94
- **0010** //1280x720p60
- **1010** //1920x1080i50
- **0110** //1920x1080i59.94
- **1110** //1920x1080i60
- **0001** //1920x1080p23.98
- **1001** //1920x1080p24
- **0101** //1920x1080p25
- **1101** //1920x1080p29.97
- **0011** //1920x1080p30
- **1011** //1920x1080p50
- **0111** //1920x1080p59.94
- **1111** //1920x1080p60

### Span Scan

16:9 selected for SD (4:3) out

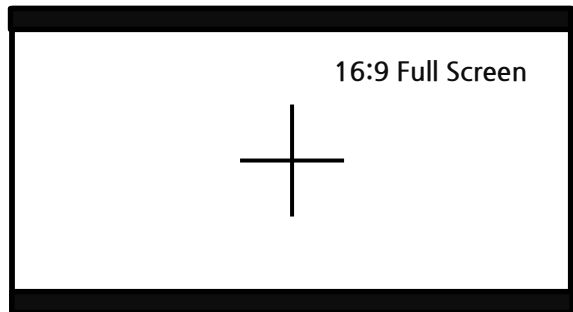

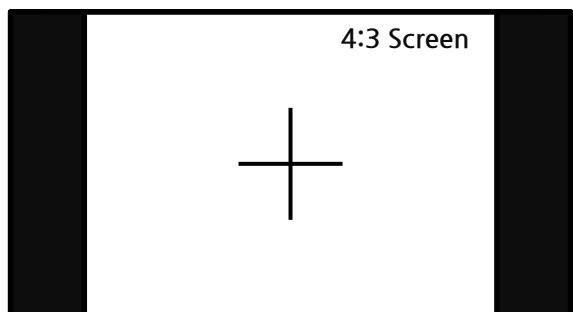

4:3 selected for HD(16:9) out



## 2.4 System Specification

ez-as+ (CVBS to 3G/HS/SD-SDI Converter with Scaler)	
<b>Video Input Format</b>	
CVBS	
NTSC	720x480i @59.94, 720x576i @50
PAL	720x576i @50
<b>Video Output Format</b>	
720x480i @59.94, 720x576i @50	
1280x720p @50/59.94/60	
1920x1080i @50/59.94/60	
1920x1080p @23.98/24/25/29.97/30	
1920x1080p @50/59.94/60	
<b>Video Aspect Ratio</b>	
Full / Letter Box	
<b>Audio Input Connector : 6.35mm (1/4") Balanced audio Left and Right x1 each</b>	
<b>Video Input Connector : CVBS x1,</b>	
<b>Video Output Connector : BNC x2 (3G/HD/SD-SDI)</b>	
<b>DC Input Power : 5V~18V</b>	
<b>Power Consumption : &lt; 3W</b>	
<b>Dimensions : 131 x 98.8 x 28.4 mm</b>	

## 3. System flow diagram

-  Balanced audio 6.35mm(1/4")
-  HDMI
-  3G/HD/SD-SDI

