

Robin BMFL FollowSpot LT

Photometric Diagram

Lamp: Osram Lok-it! HTI 1700/PS

Min. Zoom

Lamp power=1700W
Total Output: 32800 lumens

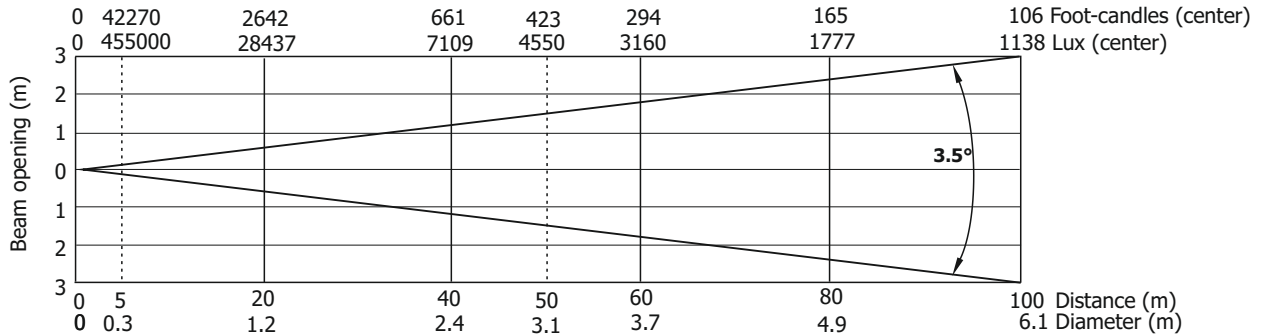

Lamp power=1500W
Total Output: 29190 lumens

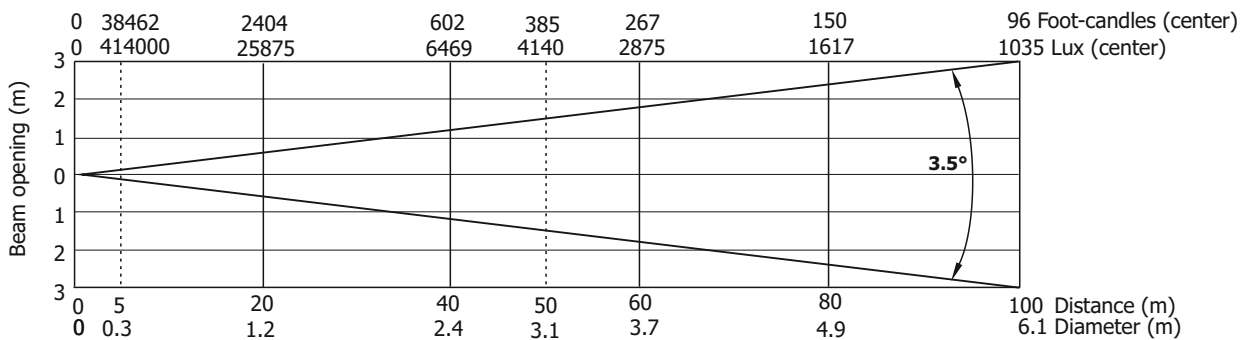

Quiet mode
Total Output: 25760 lumens

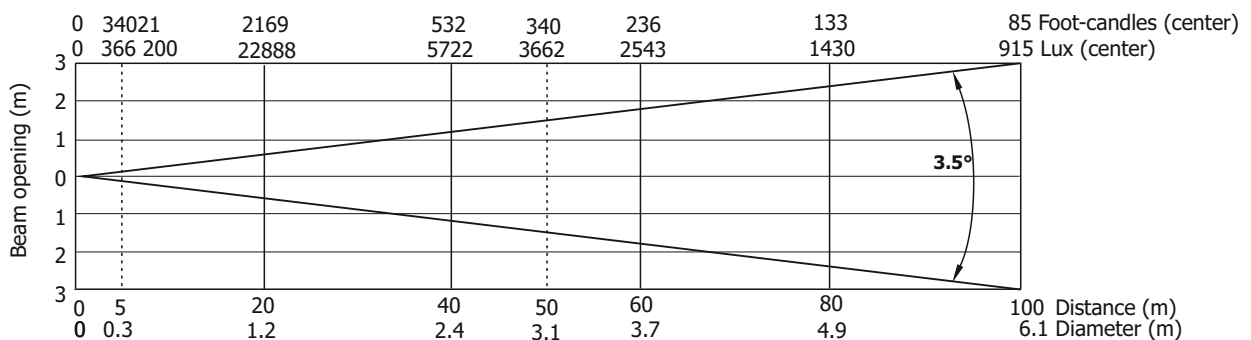

Robin BMFL FollowSpot LT

Photometric Diagram

Lamp: Osram Lok-it! HTI 1700/PS

Min. Zoom with min. iris aperture (Standard mode)

Lamp power=1700W

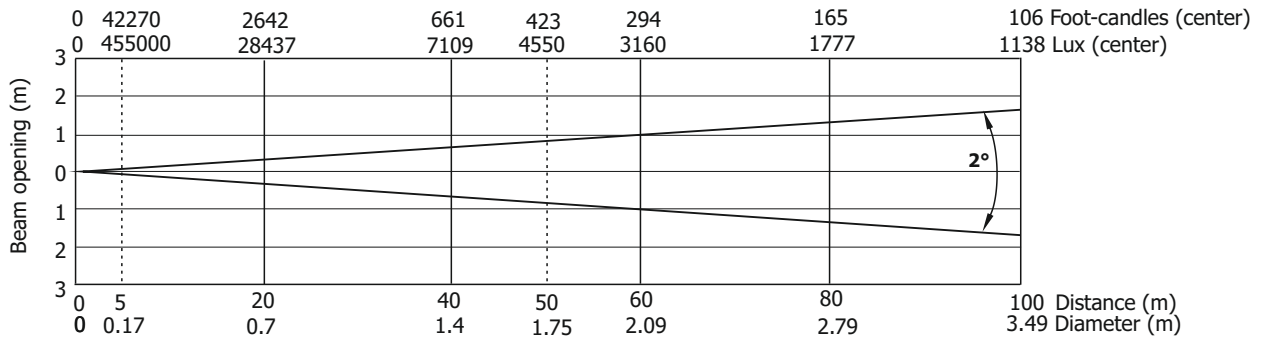

Lamp power=1500W
Total Output: 29190 lumens

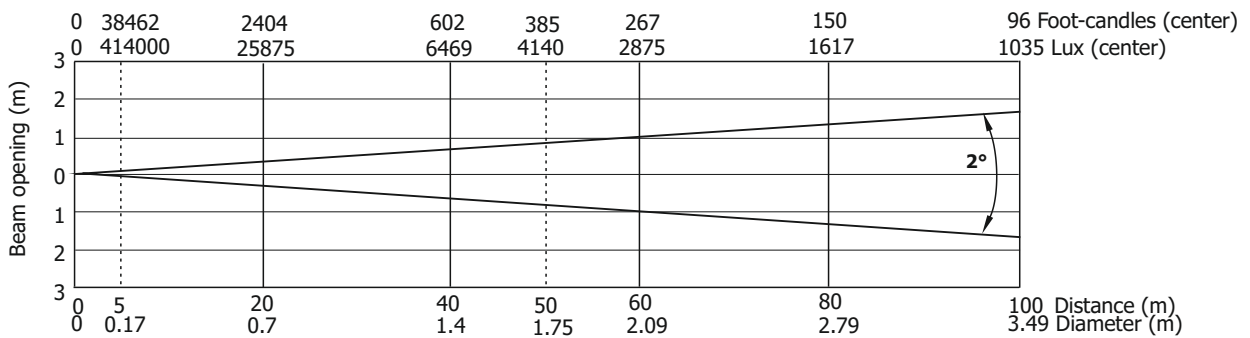

Quiet mode
Total Output: 25760 lumens

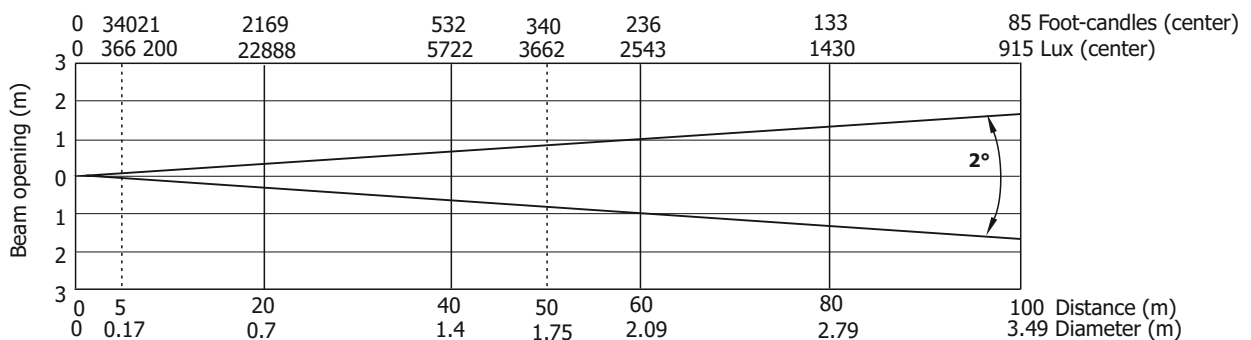

Robin BMFL FollowSpot LT

Photometric Diagram

Lamp: Osram Lok-it! HTI 1700/PS

Min. Zoom with min. iris aperture (Narrowed mode)

Lamp power=1700W/1500W/Quiet mode

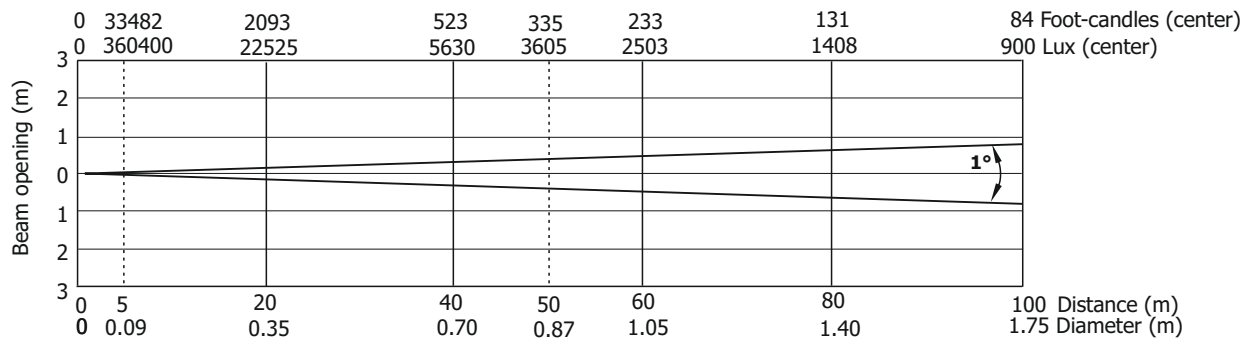

Robin BMFL FollowSpot LT

Photometric Diagram

Max. Zoom

Lamp power=1700W
Total Output: 34600 lumens

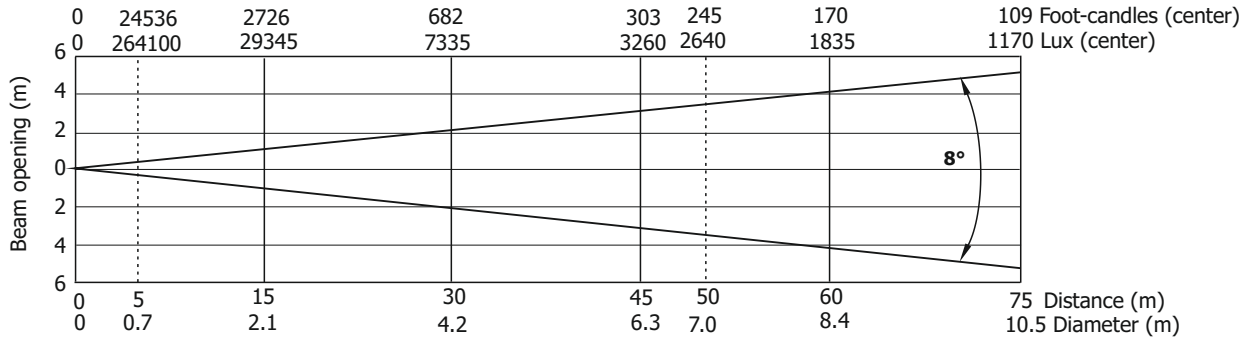

Lamp power=1500W
Total Output: 32180 lumens

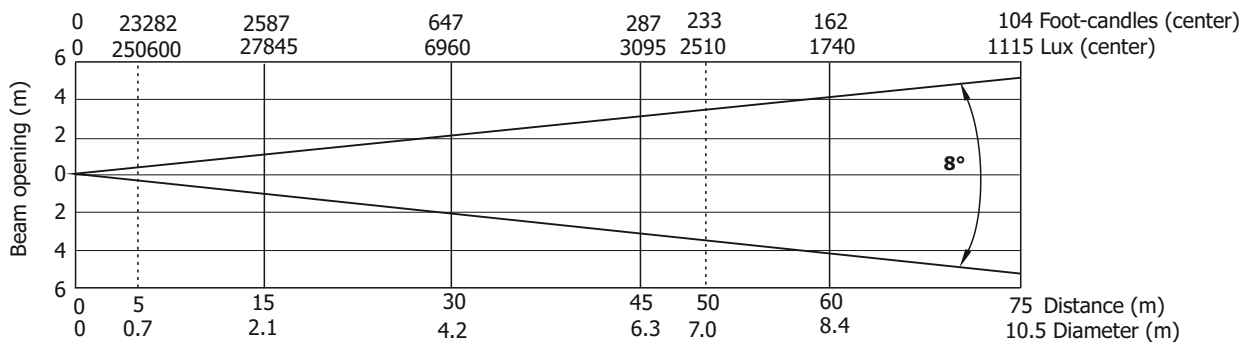

Quiet mode
Total Output: 28370 lumens

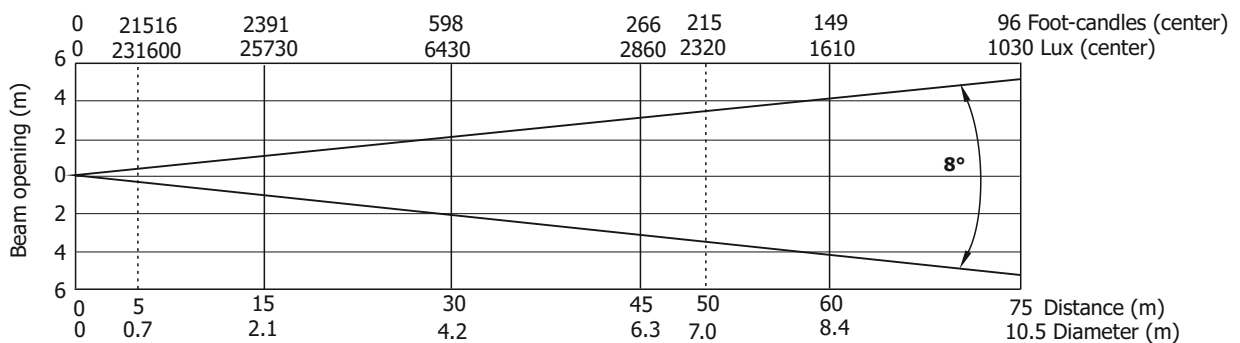

Robin BMFL FollowSpot LT

Photometric Diagram Min. Zoom with Light Frost

Lamp power=1700W

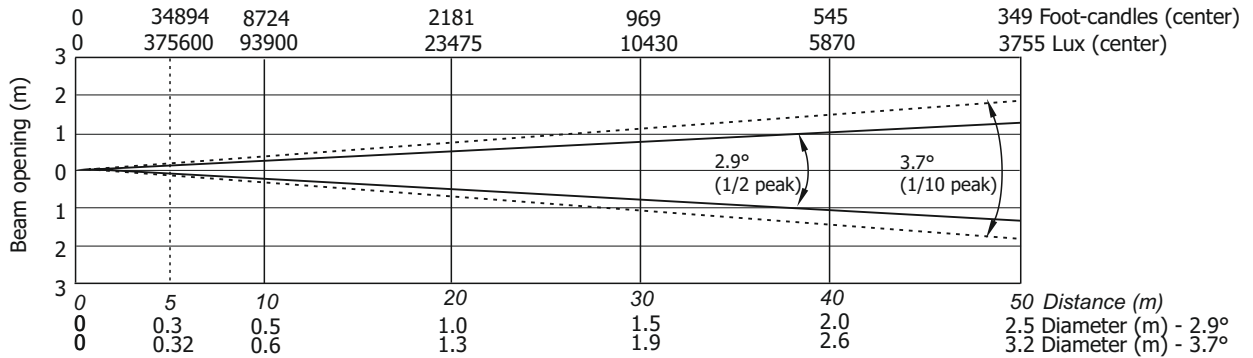

Illuminance distribution

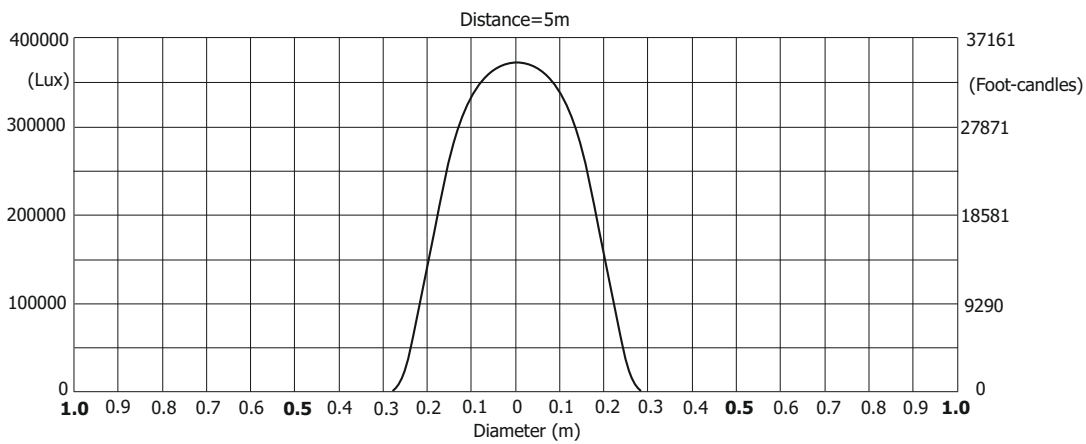

Lamp power=1500W

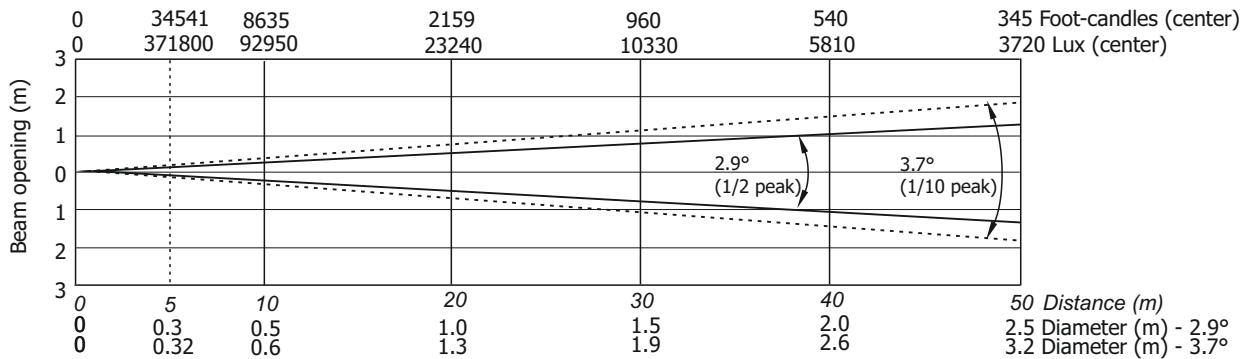

Illuminance distribution

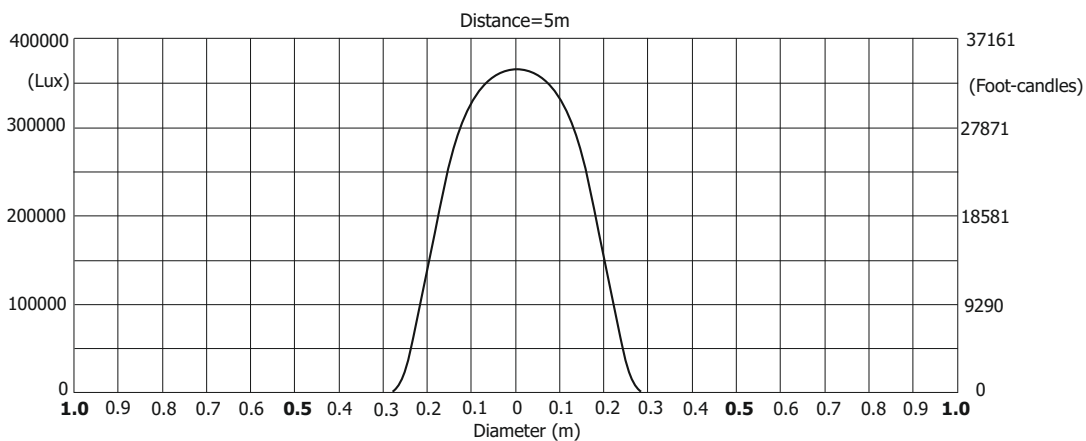

Robin BMFL FollowSpot LT

Photometric Diagram

Min. Zoom with Light Frost

Quiet mode

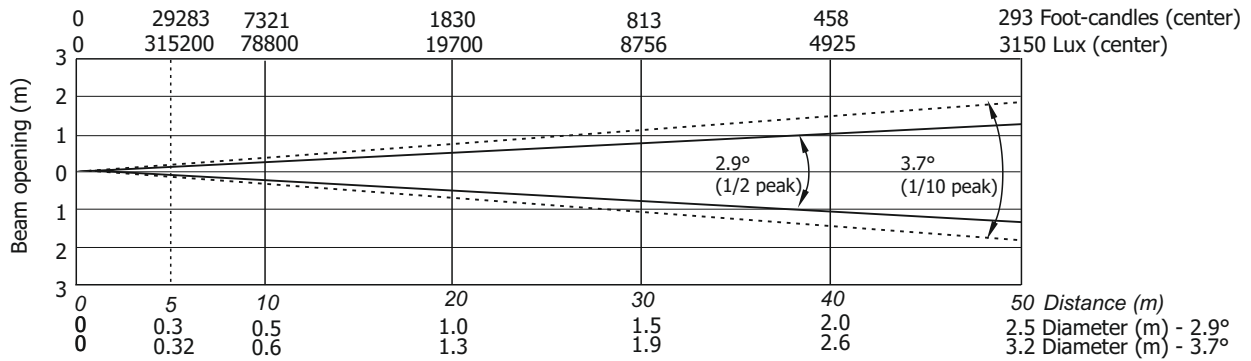

Illuminance distribution

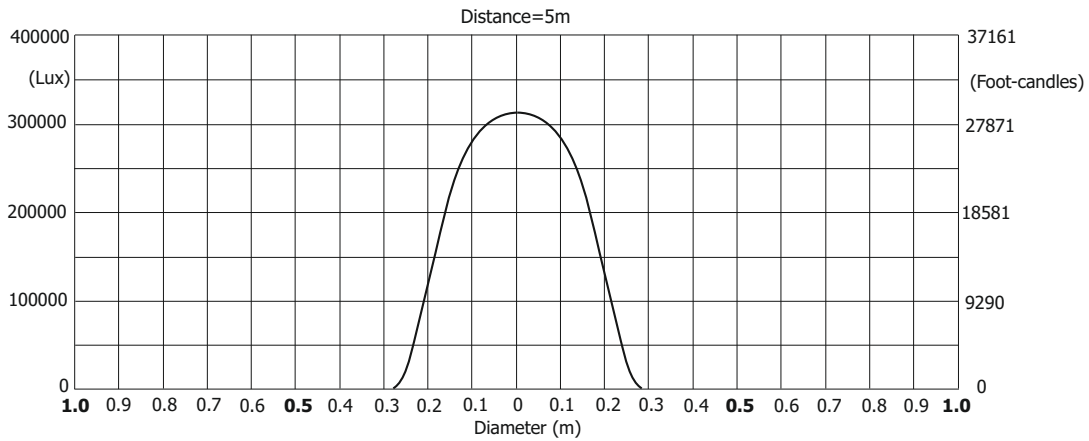

Robin BMFL FollowSpot LT

Photometric Diagram Min. Zoom with Medium Frost

Lamp power=1700W

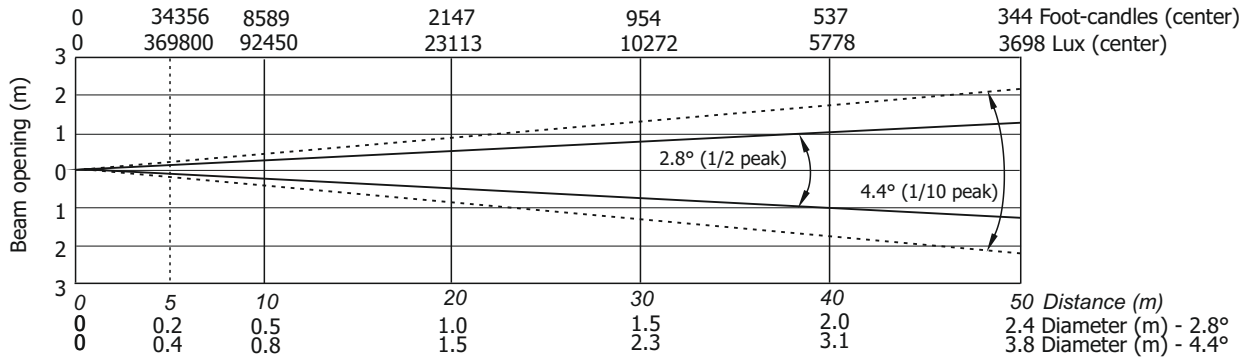

Illuminance distribution

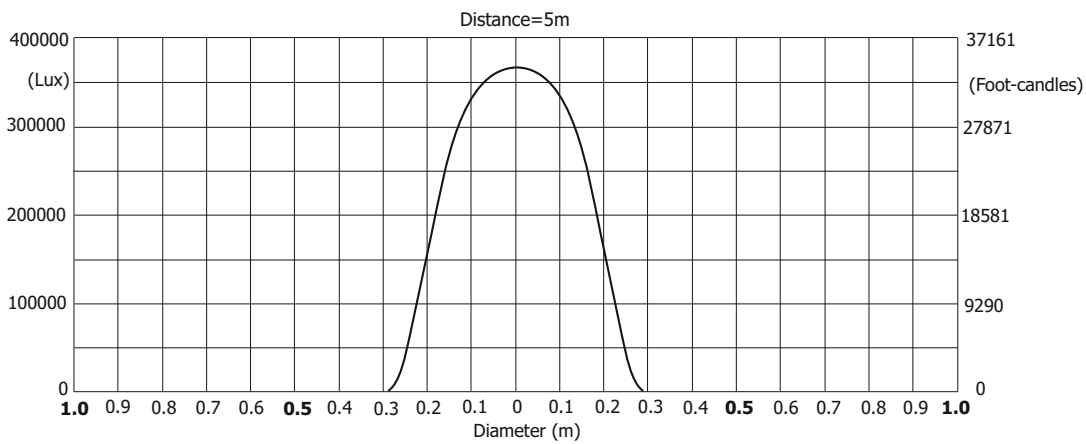

Lamp power=1500W

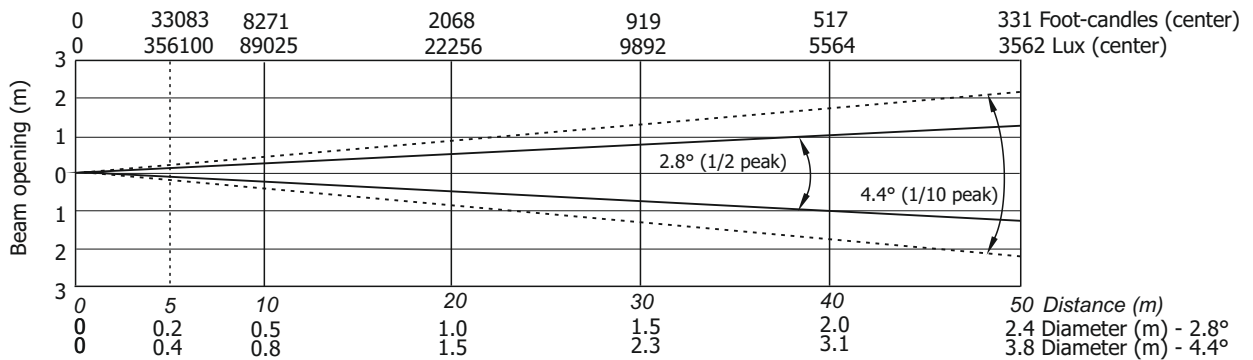

Illuminance distribution

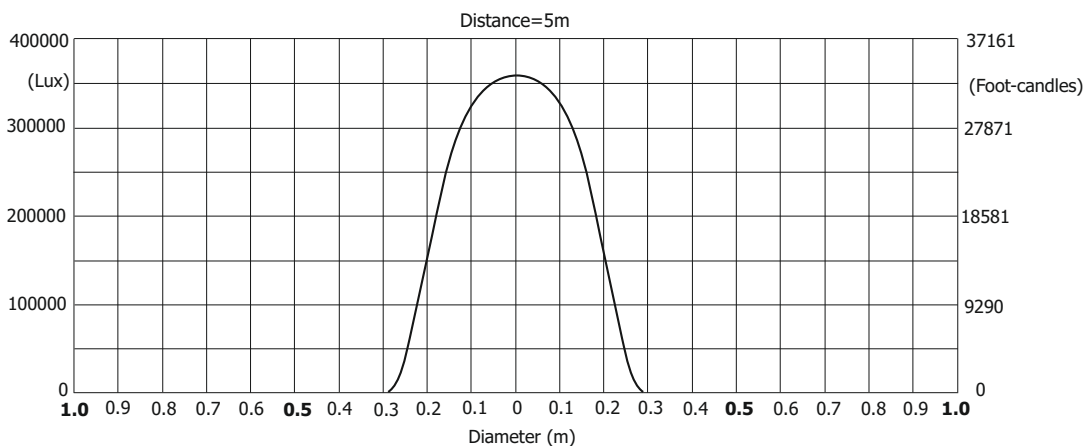

Robin BMFL FollowSpot LT

Photometric Diagram

Min. Zoom with Medium Frost

Quiet mode

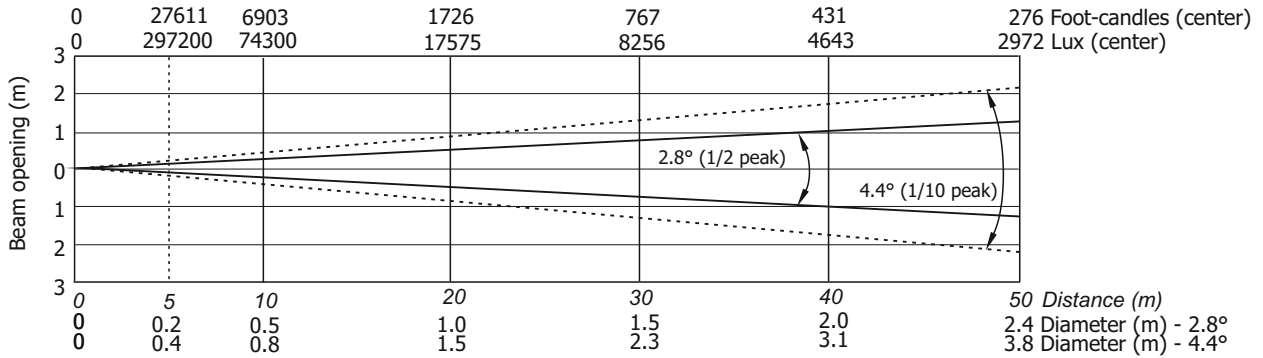

Illuminance distribution

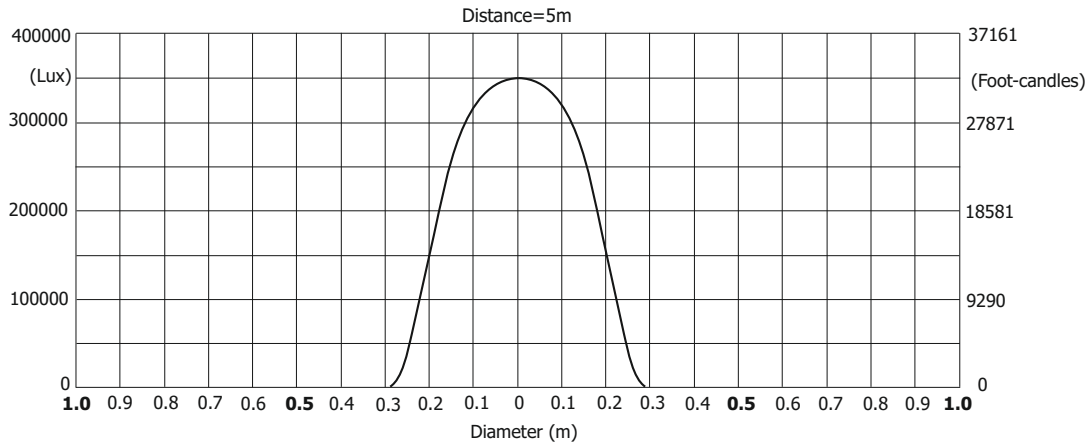

Robin BMFL FollowSpot LT

Photometric Diagram

Min. Zoom with Heavy Frost 20° (standard)

Lamp power=1700W

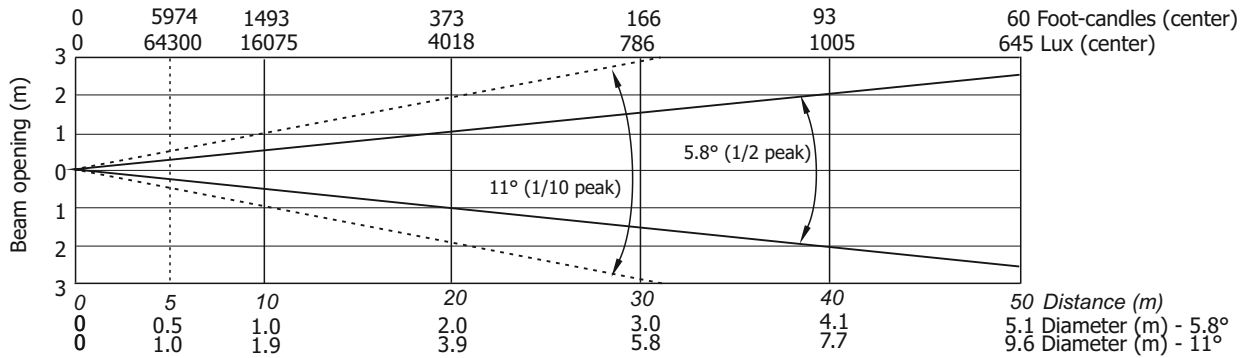

Illuminance distribution

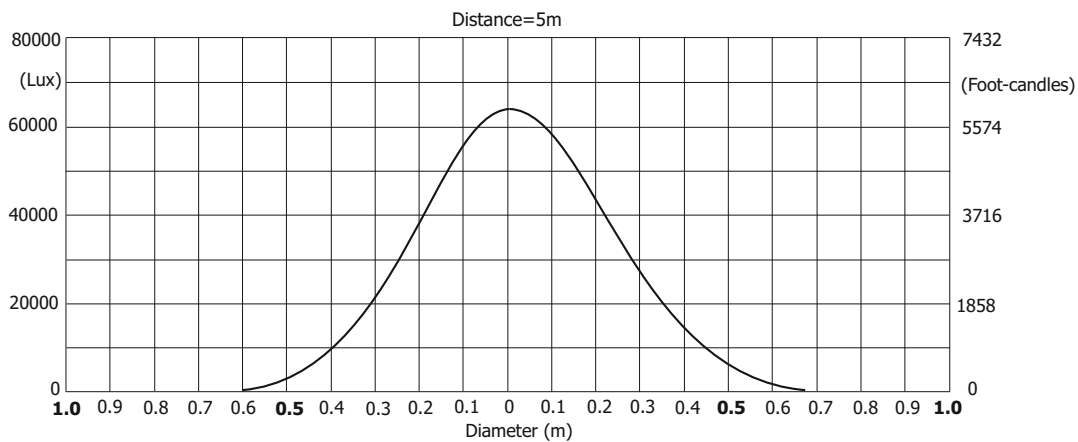

Lamp power=1500W

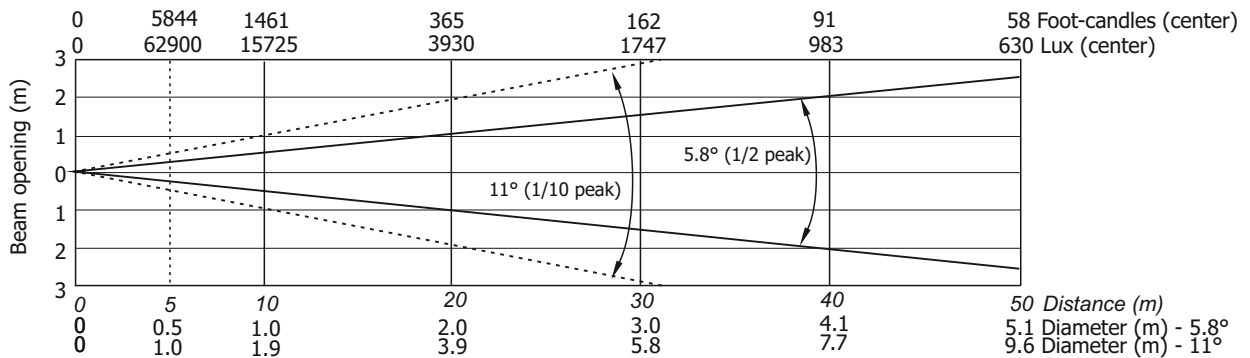

Illuminance distribution

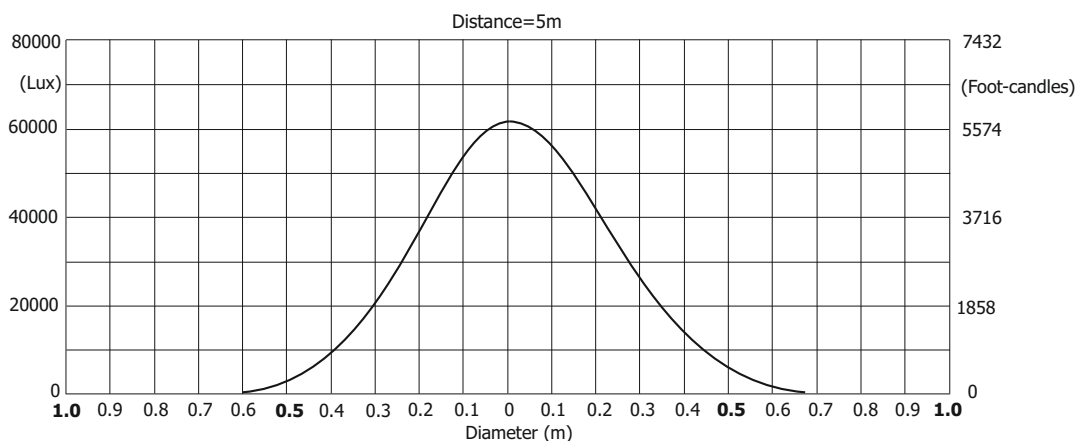

Robin BMFL FollowSpot LT

Photometric Diagram

Min. Zoom with Heavy Frost 20° (standard)

Quiet mode

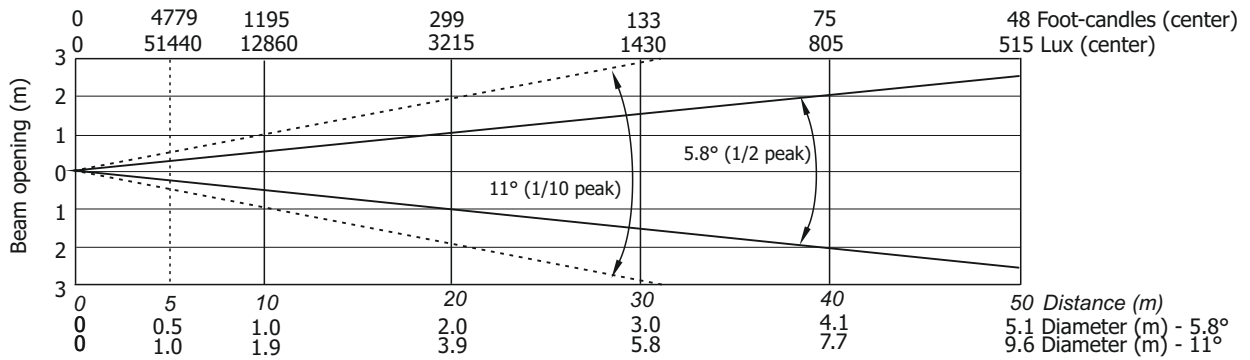

Illuminance distribution

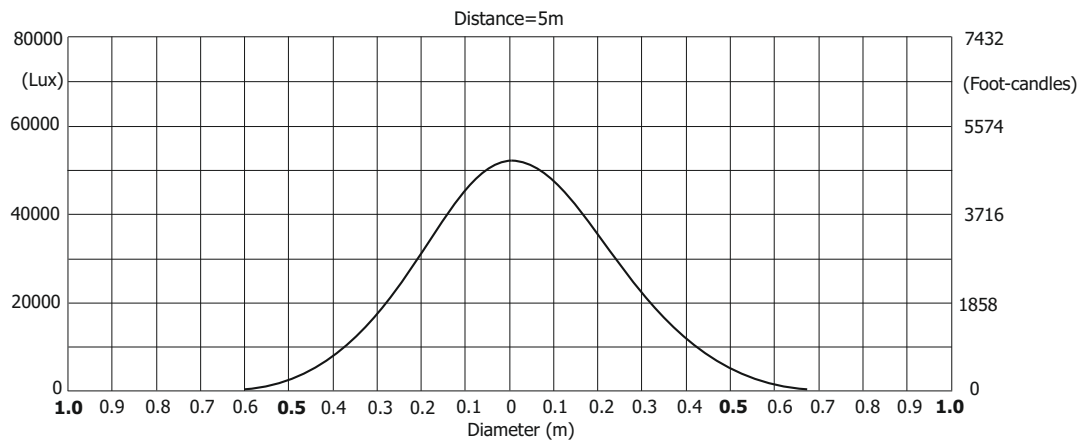

Robin BMFL FollowSpot LT

Photometric Diagram

Max. Zoom with Light Frost

Lamp power=1700W

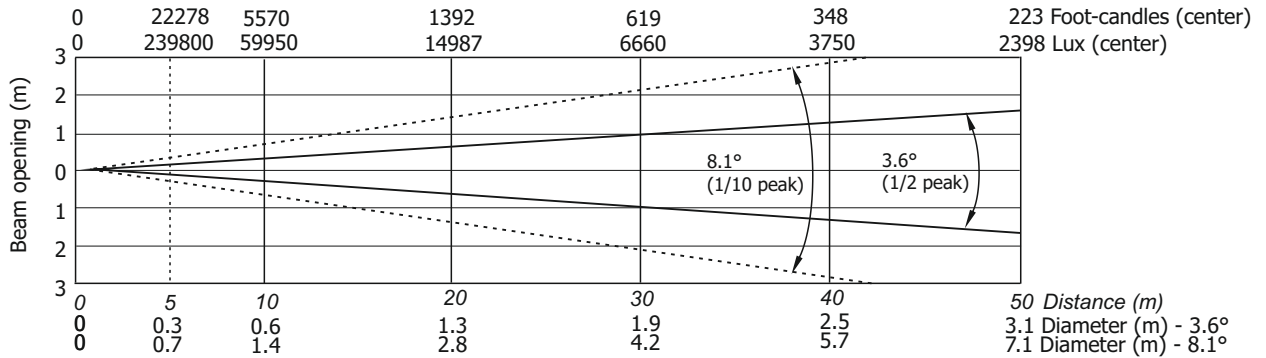

Illuminance distribution

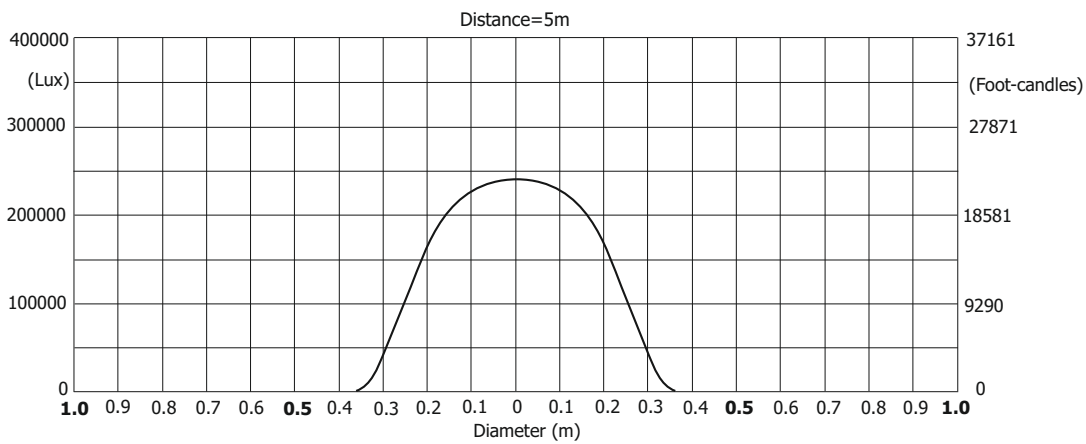

Lamp power=1500W

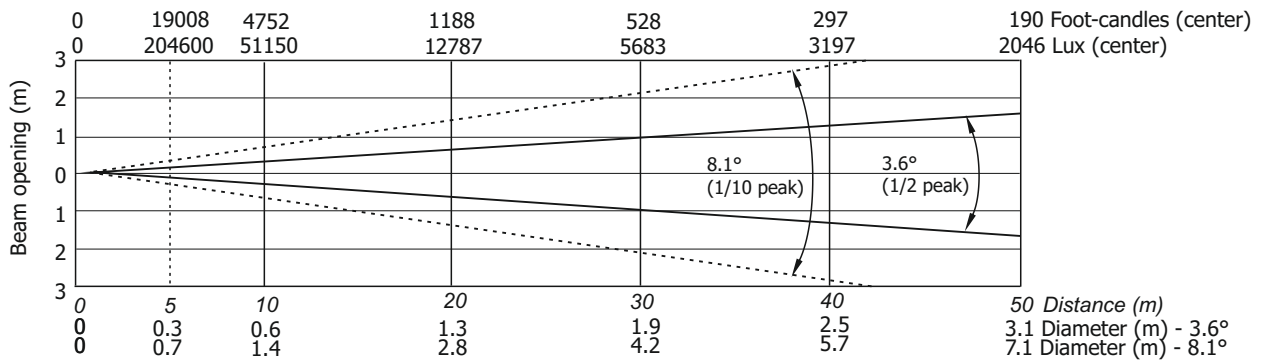

Illuminance distribution

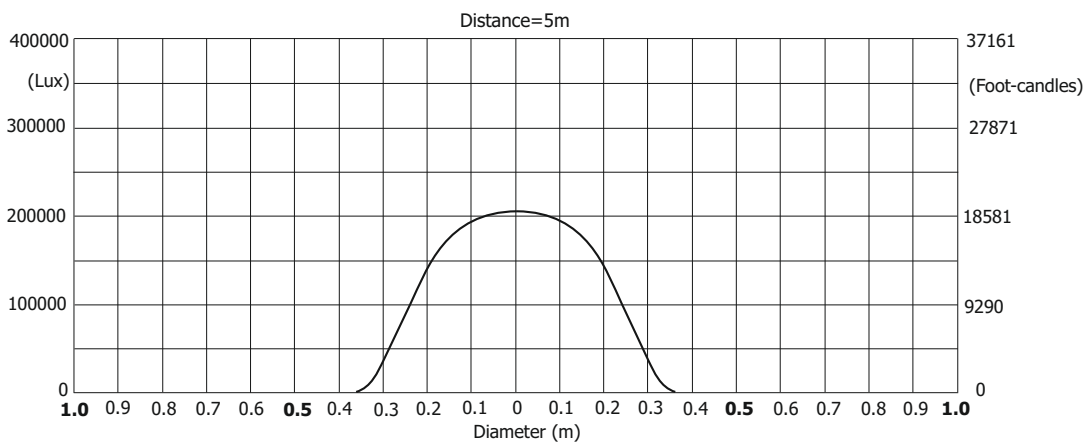

Robin BMFL FollowSpot LT

Photometric Diagram

Max. Zoom with Light Frost

Quiet mode

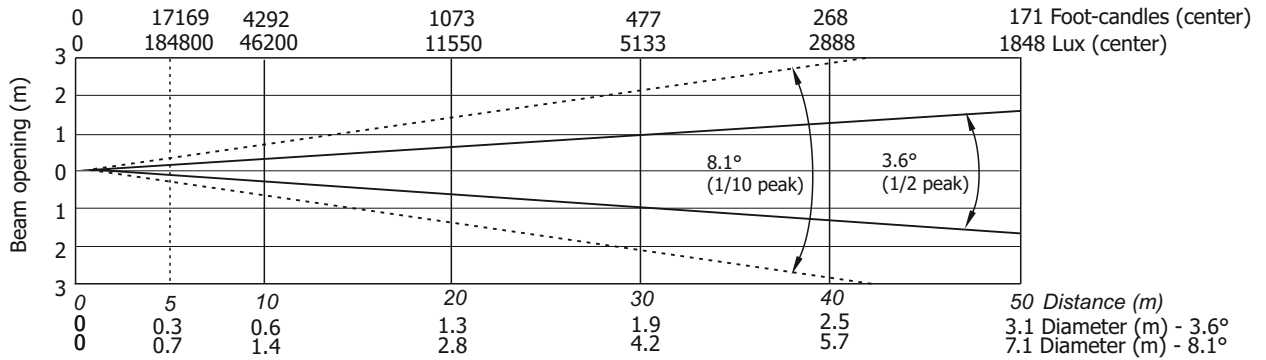

Illuminance distribution

Distance=5m

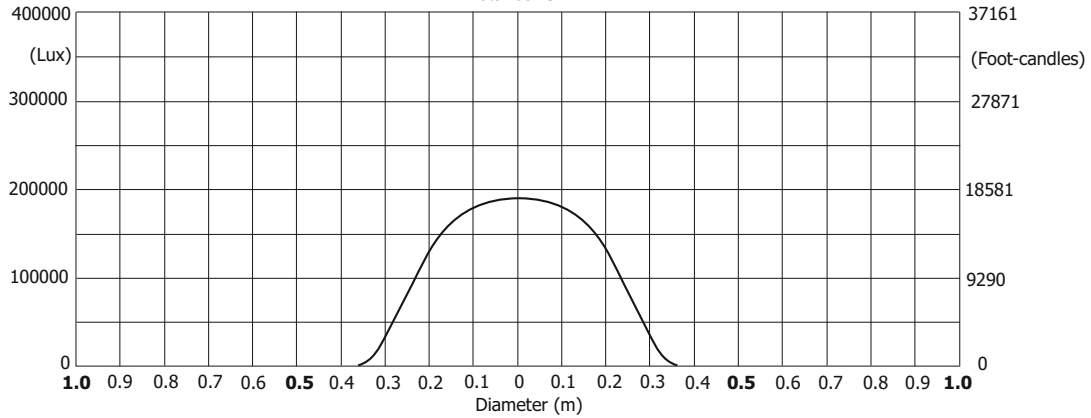

Robin BMFL FollowSpot LT

Photometric Diagram

Max. Zoom with Medium Frost

Lamp power=1700W

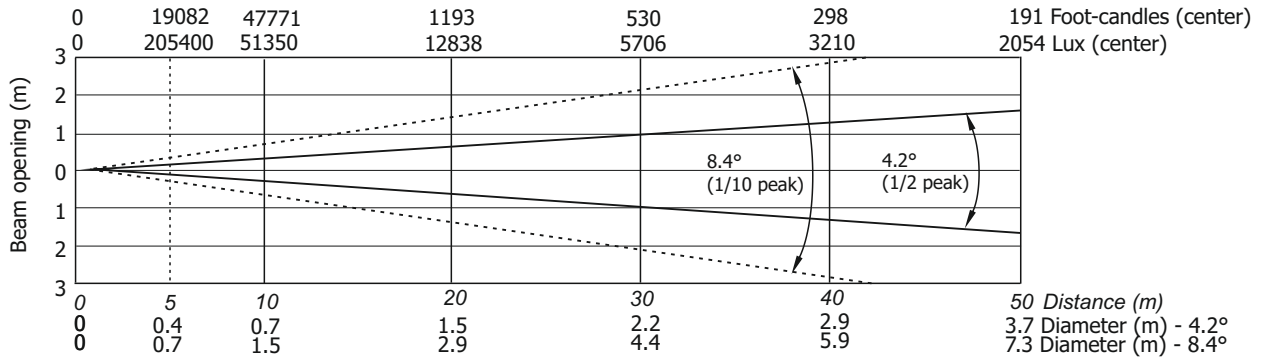

Illuminance distribution

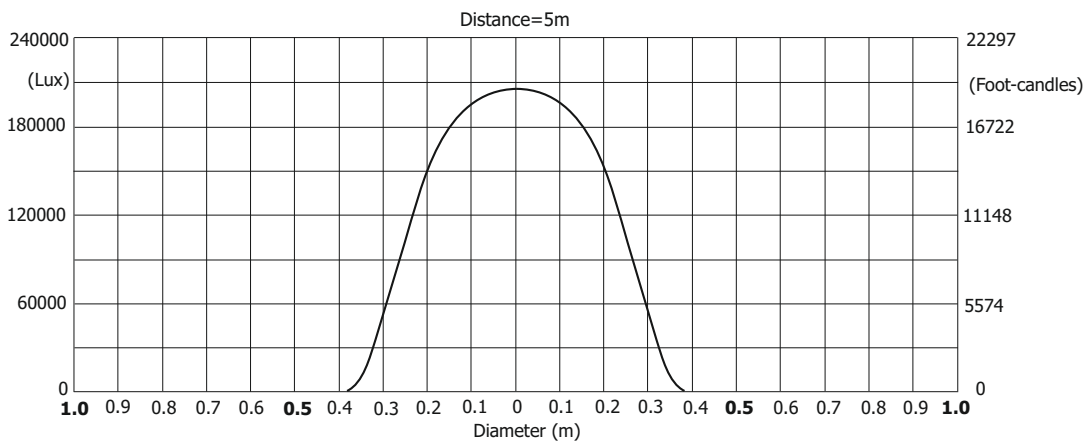

Lamp power=1500W

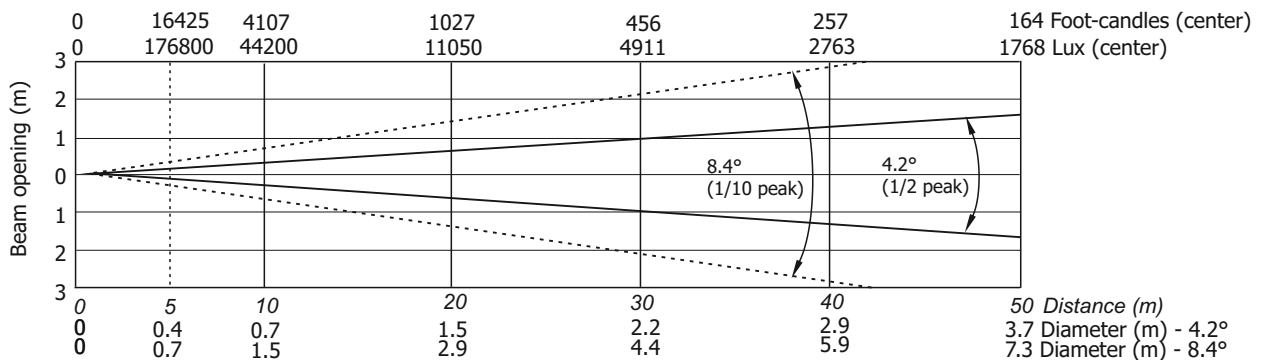

Illuminance distribution

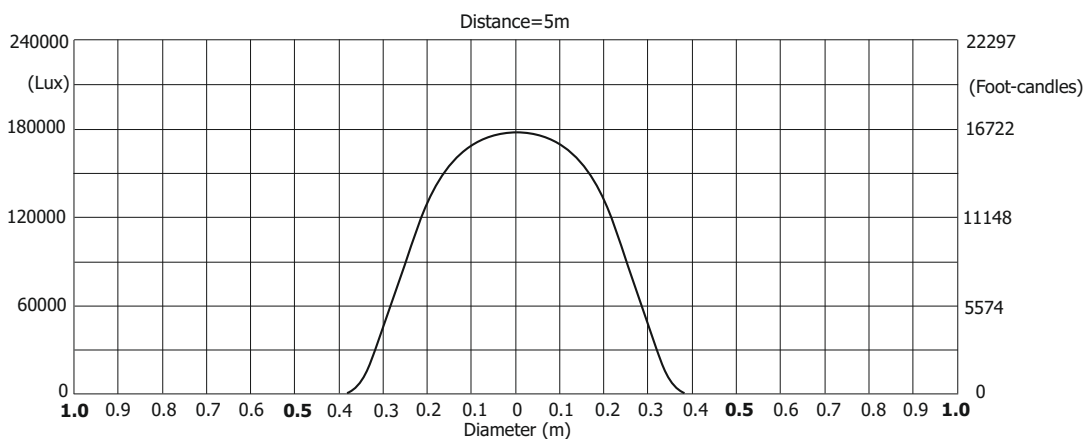

Robin BMFL FollowSpot LT

Photometric Diagram

Max. Zoom with Medium Frost

Quiet mode

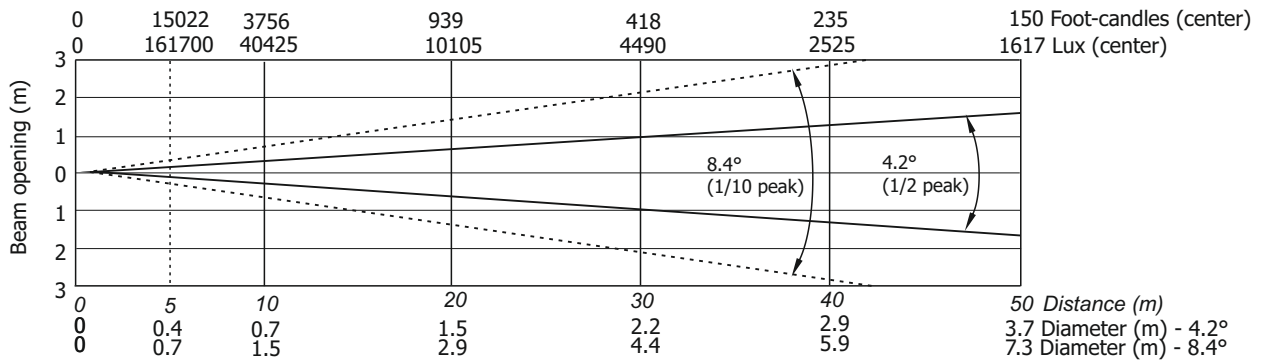

Illuminance distribution

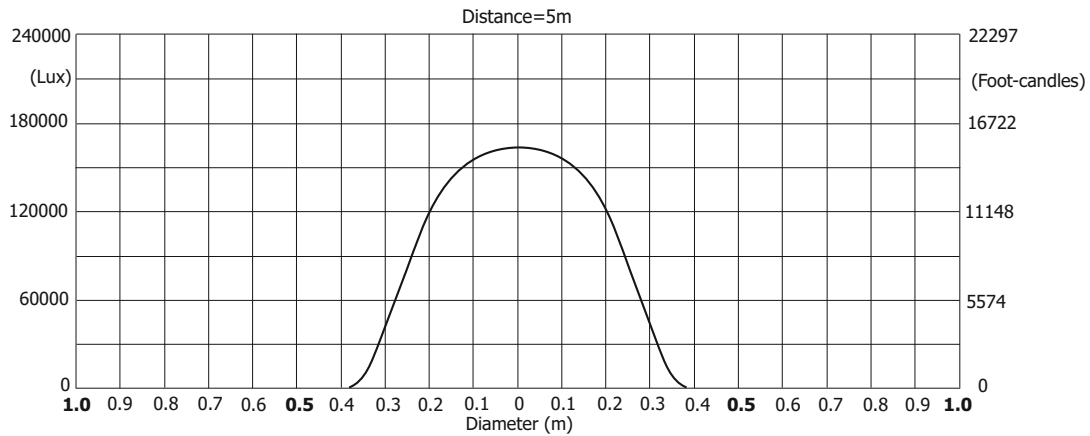

Robin BMFL FollowSpot LT

Photometric Diagram

Max. Zoom with Heavy Frost 20° (standard)

Lamp power=1700W

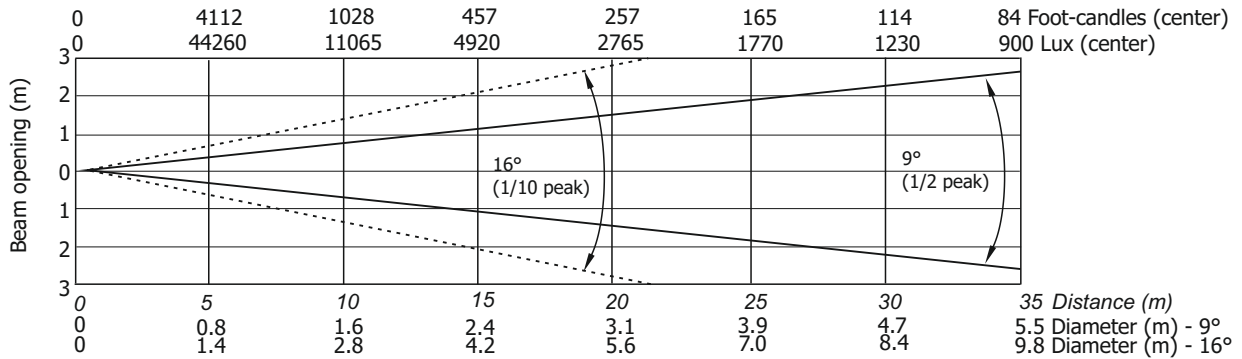

Illuminance distribution

Distance=5m

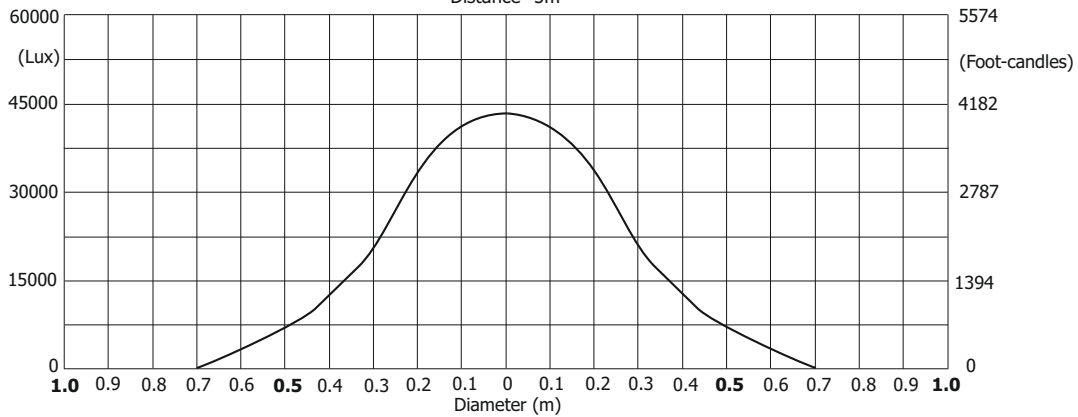

Lamp power=1500W

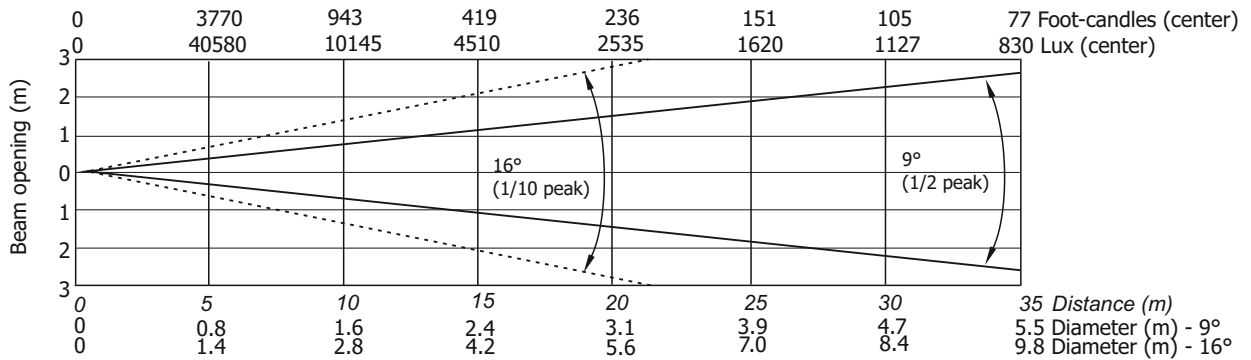

Illuminance distribution

Distance=5m

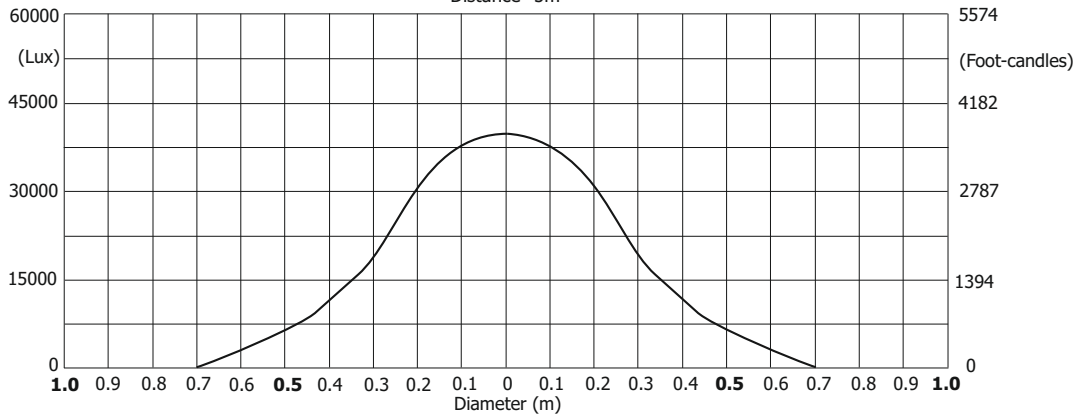

Robin BMFL FollowSpot LT

Photometric Diagram

Max. Zoom with Heavy Frost 20° (standard)

Quiet mode

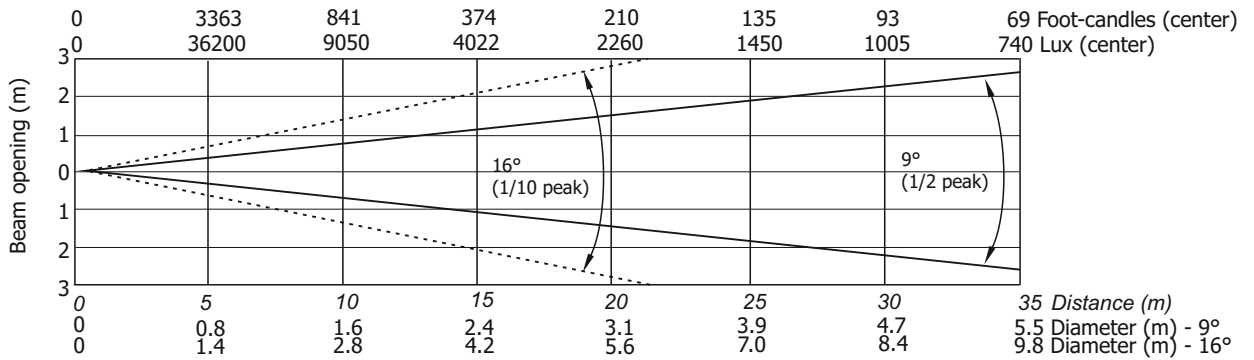

Illuminance distribution

Distance=5m

