



ENGLISH

Domotion DLC-4 RGBW

V1

ordercode: A9915058/A9915059

Table of contents

Warning	2
Safety Instructions	2
Operating Determinations	4
Connection with the mains	4
Return Procedure	5
Claims	5
Description of the device	6
Optional accessories	6
Frontside	7
Backside	7
Installation	8
Set Up and Operation	8
Setup example	8
1. Power function	9
1.1 Shortcut power function	9
1.2 Fadetime power function	9
2. Built-in program	9
3. Brightness	9
4. Speed	10
5. Color	10
5.1 Choose color	10
5.2 Save color	10
5.3 Playback color	10
5.4 Fade time color change	10
6. Scene	11
6.1 Save scene	11
6.2 Playback scene	11
6.3 Lock/unlock	11
7. Button click	11
8. Default settings	11
9. Multiple devices	11
Maintenance	12
Troubleshooting	12
No Reaction fixture	12
No Response to DMX	12
Product Specifications	14
Dimensions	14

Warning



**For your own safety, please read this user manual carefully
before your initial start-up!**



Unpacking Instructions

Immediately upon receiving this product, carefully unpack the carton and check the contents to ensure that all parts are present, and have been received in good condition. Notify the dealer immediately and retain packing material for inspection if any parts appear damaged from shipping or the carton itself shows signs of mishandling. Save the carton and all packing materials. In the event that a fixture must be returned to the factory, it is important that the fixture be returned in the original factory box and packing.

Your shipment includes:

- Artecta Domotion DLC-4 RGBW
- User manual



CAUTION!

**Keep this device away from rain and moisture!
Unplug mains lead before opening the housing!**



Safety Instructions

Every person involved with the installation, operation and maintenance of this device has to:

- be qualified
- follow the instructions of this manual



**CAUTION! Be careful with your operations.
With a dangerous voltage you can suffer
a dangerous electric shock when touching the wires!**



Before the initial start-up, please make sure that there is no damage caused by transportation. Should there be any, consult your dealer and do not use the device.

To maintain perfect condition and to ensure a safe operation, it is absolutely necessary for the user to follow the safety instructions and warning notes contained in this manual.

Please consider that damages caused by manual modifications to the device are not subject to warranty.

This device contains no user-serviceable parts. Refer servicing to qualified technicians only.

IMPORTANT:

The manufacturer will not accept liability for any resulting damages caused by the non-observance of this manual or any unauthorized modification to the device.

- Never let the power cord come into contact with other cables! Handle the power cord and all connections with the mains with particular caution!
- Never remove warning or informative labels from the unit.
- Never use anything to cover the ground contact.
- Never leave any cables lying around.
- Do not switch the device on and off in short intervals, as this will reduce the device's life.
- Do not shake the device. Avoid brute force when installing or operating the device.
- Only use the device indoors, avoid contact with water or other liquids.
- Only operate the device after having familiarized with its functions.
- Avoid flames and do not put close to flammable liquids or gases.
- Always keep the case closed while operating.
- Always allow a free air space of at least 50 cm around the unit for ventilation.
- Always disconnect power from the mains, when device is not used or before cleaning! Only handle the power cord holding it by the plug. Never pull out the plug by tugging the power cord.
- Make sure that the device is not exposed to extreme heat, moisture or dust.
- Make sure that the available voltage is not higher than stated on the rear panel.
- Make sure that the power cord is never crimped or damaged. Check the device and the power cord from time to time.
- If device was dropped or struck, disconnect mains power supply immediately. Have a qualified engineer inspect for safety before operating.
- If the device has been exposed to drastic temperature fluctuation (e.g. after transportation), do not switch it on immediately. The arising condensation water might damage your device. Leave the device switched off until it has reached room temperature.
- If your Artecta device fails to work properly, discontinue the use immediately. Pack the unit securely (preferably in the original packing material), and return it to your Artecta dealer for service.
- For adult use only. The device must be installed beyond the reach of children. Never leave the unit running unattended.
- Never attempt to bypass the thermostatic switch or fuses.
- The user is responsible for correct positioning and operating of the DLC-4. The manufacturer will not accept liability for damages caused by the misuse or incorrect installation of this device.
- This device falls under protection class III.
- Repairs, servicing and electric connection must be carried out by a qualified technician.
- **WARRANTY:** Till one year after date of purchase.

Operating Determinations

- This device is not designed for permanent operation. Consistent operation breaks will ensure that the device will serve you for a long time without defects.
- The minimum distance between light output and the illuminated surface must be bigger than 1 meter.
- The maximum ambient temperature $t_a = 40^\circ\text{C}$ must never be exceeded.
- The relative humidity must not exceed 50 % with an ambient temperature of 40°C .
- If this device is operated in any other way than the one described in this manual, the product may suffer damages and the warranty becomes void.
- Any other operation may lead to dangers like short-circuit, burns, electric shock, crash, etc.

You endanger your own safety and the safety of others !

Improper installation can cause serious injuries and/or damage of property!

Connection with the mains

Connect the device to the mains with the power-plug.

Always check if the right color cable is connected to the right place.

International	EU Cable	UK Cable	US Cable	Pin
L	BROWN	RED	YELLOW/COPPER	PHASE
N	BLUE	BLACK	SILVER	NEUTRAL
	YELLOW/GREEN	GREEN	GREEN	PROTECTIVE GROUND

Make sure that the device is always properly connected to the earth!

Improper installation can cause serious injuries and/or damage of property!

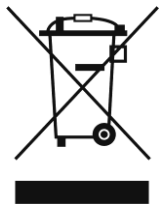

Return Procedure

Returned merchandise must be sent prepaid and in the original packing, call tags will not be issued. Package must be clearly labeled with a Return Authorization Number (RMA number). Products returned without an RMA number will be refused. Highlite will not accept the returned goods or any responsibility. Call Highlite 0031-455667723 or mail offersales@highlite.nl and request an RMA prior to shipping the fixture. Be prepared to provide the model number, serial number and a brief description of the cause for the return. Be sure to properly pack fixture, any shipping damage resulting from inadequate packaging is the customer's responsibility. Highlite reserves the right to use its own discretion to repair or replace product(s). As a suggestion, proper UPS packing or double-boxing is always a safe method to use.

Note: If you are given an RMA number, please include the following information on a piece of paper inside the box:

- 01) Your name
- 02) Your address
- 03) Your phone number
- 04) A brief description of the symptoms

Claims

The client has the obligation to check the delivered goods immediately upon delivery for any shortcomings and/or visible defects, or perform this check after our announcement that the goods are at their disposal. Damage incurred in shipping is the responsibility of the shipper; therefore the damage must be reported to the carrier upon receipt of merchandise.

It is the customer's responsibility to report and submit claims with the shipper in the event that a fixture is damaged due to shipping. Transportation damage has to be reported to us within one day after receipt of the delivery.

Any return shipment has to be made post-paid at all times. Return shipments must be accompanied with a letter defining the reason for return shipment. Non-prepaid return shipments will be refused, unless agreed otherwise in writing.

Complaints against us must be prepared in writing or sent by fax within 10 working days after receipt of the invoice. After this period complaints will not be handled anymore.

Complaints will only then be considered if the client has so far complied with all parts of the agreement, regardless of the agreement from which the obligation is resulting.

Description of the device

Features

The Domotion DLC-4 RGBW is the successor of the popular Domotion DLC-4 RGB from Artecta. It is equal to the Domotion RGB, but has RGBW on board. It is a compact RGBW LED controller and easy to use.

- LED indicator to display the current output
- Four function menus
- Fade time for Power on/off
- Memory and power failure protection
- Playback: 4-4 preset scenes/colors
- Input Voltage: 12-24 VDC
- Power: 2A/kanal, total 8A max
- Channels: 4
- Dimming: DMX
- IP rating: IP20
- Protection class: III
- Operating temperature: 0-40°C
- Dimensions: 85 x 85 x 15 mm (LxWxH)
- Weight: 0,1 kg

Note: Knowledge of DMX is required to fully utilize this unit.

Optional accessories

[A9900030](#) Domotion Wallbox PSU

[A9900031](#) Domotion Wall Box PSU

[A9915850](#) Play-III LED DMX Dimmer

[A9930004](#) Mountingbox U50 82mm

[A9950050](#) LINEARdrive Constant voltage

[A9950051](#) LINEARdrive Constant voltage

Frontside

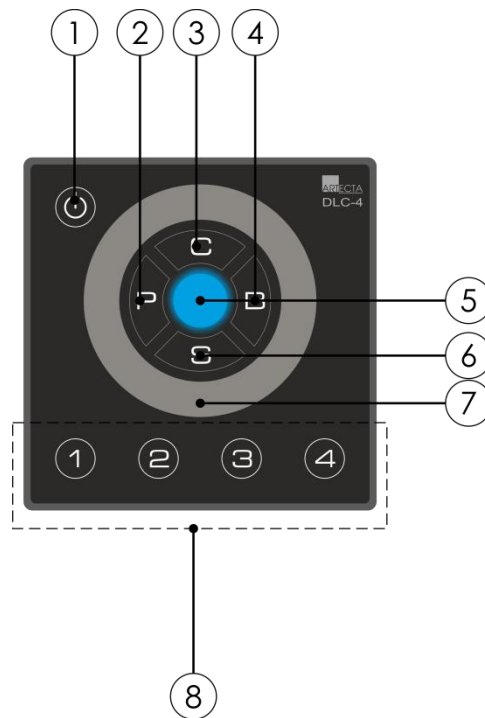

Fig. 01

- 01) Power ON/OFF
- 02) Built-in Program button
- 03) Color button
- 04) Brightness button
- 05) Output indicator
- 06) Speed button
- 07) Circular Touchpad
- 08) Figure buttons

Backside

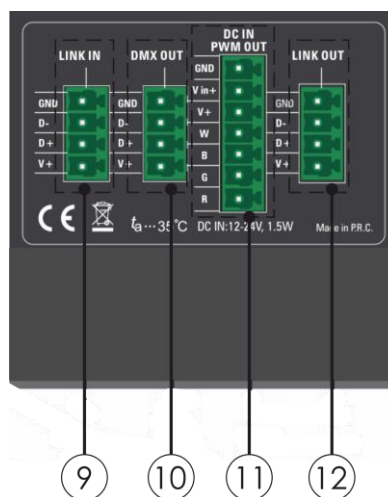

Fig. 02

- 09) 4-pin terminal Link In
- 10) 4-pin terminal DMX out
- 11) 7-pin terminal PWM out & Power In
- 12) 4-pin terminal Link Out

Installation

Remove all packing materials from the Domotion DLC-4 RGBW. Check if all foam and plastic padding is removed. Connect all cables.

Do not supply power before the whole system is set up and connected properly.

Always disconnect from electric mains power supply before cleaning or servicing.

Damages caused by non-observance are not subject to warranty.

Set Up and Operation

Follow the directions below, as they pertain to your preferred operation mode.

Before plugging the unit in, always make sure that the power supply matches the product specification voltage. Do not attempt to operate a 120V specification product on 230V power, or vice versa.

Setup example

Follow the instructions below for a proper way to setup the DLC-4 (see Fig. 03).

- 01) Connect the DLC-4 with the required 12V or 24V power supply.
- 02) Connect the DLC-4 with RGBW light fixtures (max 8A).
- 03) Connect the required 12V or 24V power supply to a DMX dimmerpack.
- 04) Connect the DLC-4 with the dimmerpack using the DMX out.
- 05) Connect the dimmerpack with the RGBW light fixtures.

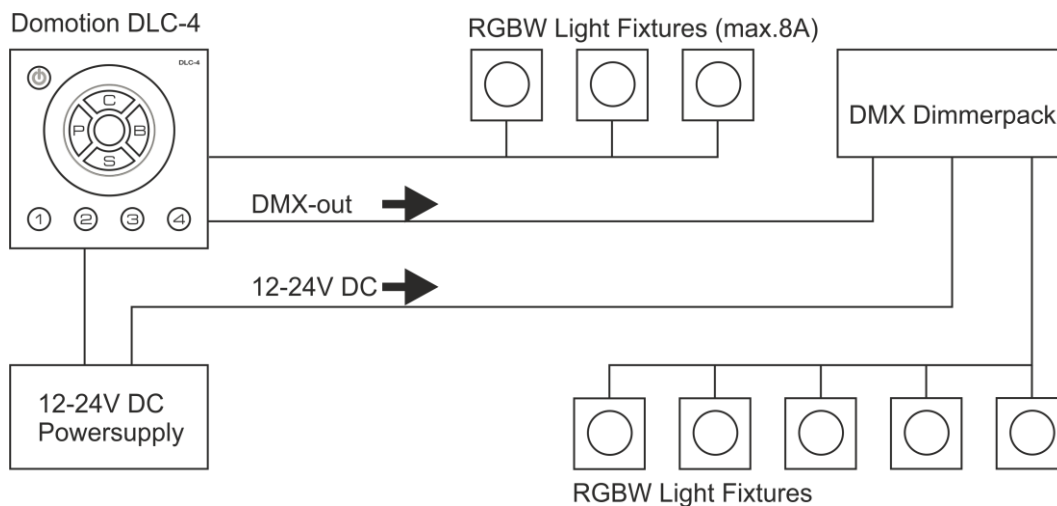

Fig. 03

- 06) Mount the DLC-4 on a wallbox, see Fig. 04.

Dimensions in mm

Remove screws A & B for mounting on a wallbox

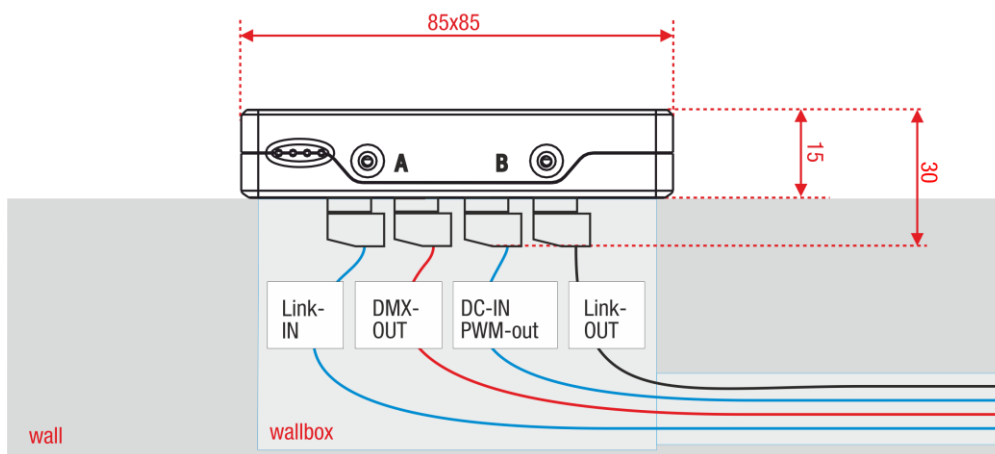

Fig. 04

1. Power function

When the DLC-4 is connected to a 12V or 24V power supply, the power button lights up. The device is ready to operate and resumes with the last known settings. In normal mode you can press the Power button for 2s and the device will switch to standby mode. The output will shut down. Press the Power button again for 2s, the device will start up.

1.1 Shortcut power function

- 01) Press the P-button and the Power button simultaneously for 10 seconds until all buttons flash once. The shortcut function is now ready to use.
- 02) If you press the Power button once, the DLC-4 will go to its standby modus.
- 03) Press any button to start up the DLC-4.
- 04) To delete the shortcut, simultaneously press the P-button and the Power button again for 10 seconds until all buttons flash once.
- 05) The shortcut is deleted.

1.2 Fadetime power function

- 01) Press the Power button for 5 seconds until all buttons flash once.
- 02) Release the Power button, the button will flash repeatedly.
- 03) You can set the fade time with the buttons according to Fig. 05.

Button	1	2	3	4	P/C/B/S
Fade time	1s	2s	3s	4s	0s (no Fade time)

Fig. 05

- 04) After setting the fade time, all buttons will flash once to confirm the fade time.
- 05) The device will automatically switch to normal mode.

2. Built-in program

With this function you can choose a built-in program.

- 01) Press the P-button for 1 second to activate the built-in programs.
- 02) The button clicks and will light up.
- 03) Scroll through the circular touchpad to choose between 10 built-in programs and the auto program. The auto program will play the 10 built-in programs in sequence.
- 04) When a built-in program is chosen, a click will be heard.
- 05) The selected program will be activated.

3. Brightness

With this function you can set the brightness of the connected fixtures.

- 01) Press the B-button for 1 second to activate the brightness menu.
- 02) The button clicks and will light up.
- 03) Scroll through the circular touchpad to set the brightness.
- 04) Turn clockwise to increase the brightness, turn counter clockwise to decrease the brightness.
- 05) The adjustment range is between 0-255, from minimum brightness to maximum brightness.
- 06) Each step will activate a click. If no click is heard, the minimum or maximum brightness is reached.

4. Speed

With this function you can set the speed of the built-in programs.

- 01) Press the S-button for 1 second to activate the speed menu.
- 02) The button clicks and will light up.
- 03) Scroll through the circular touchpad to adjust the speed of the current built-in program.
- 04) Turn clockwise to increase the speed, turn counter clockwise to decrease the speed.
- 05) The adjustment range of the circular touchpad is between 2s-10min.
- 06) When you reach 10min, a click will be activated and the figure buttons will blink repeatedly.
- 07) The following values can be chosen, see Fig. 06.

Button	1	2	3	4
Speed	10min	20min.	30min.	40min.

Fig. 06

- 08) Press one of the figure buttons (1-4) to activate the required speed of the built-in program.
- 09) Each step will activate a click. If no click is heard, the minimum or maximum speed is reached.

5. Color

With this menu you can choose a color, save a color, playback a color and set a fade time for the desired color.

5.1 Choose color

- 01) Press the C-button for 1 second to activate the color menu.
- 02) The button clicks and will light up.
- 03) Scroll through the circular touchpad to choose the desired color.

5.2 Save color

- 01) Press the C-button for 1 second to activate the color menu.
- 02) The button clicks and will light up.
- 03) Scroll through the circular touchpad to choose the desired color.
- 04) Press one of the figure buttons (1-4) for 2 seconds to store the desired color.
- 05) All buttons will flash once to confirm the chosen color.
- 06) The desired color is stored now including the preset brightness.
- 07) The device can store up to 4 colors.

5.3 Playback color

- 01) Press the C-button for 1 second to activate the color menu.
- 02) The button clicks and will light up.
- 03) Press one of the figure buttons (1-4) to display the desired color.
- 04) The button will light up and the chosen color will be displayed.

5.4 Fade time color change

- 01) Press the C-button for 5 seconds until all buttons flash once.
- 02) Release the C-button, the button will flash repeatedly.
- 03) You can set the fade time with the buttons according to Fig. 07.

Button	1	2	3	4	P/C/B/S
Fade time	1s	2s	3s	4s	0s (no Fade time)

Fig. 07

- 04) After setting the fade time, all buttons will flash once to confirm the fade time.
- 05) The device will automatically switch to normal mode.

6. Scene

With this menu you can save a scene, playback a scene or lock/unlock recording a scene.

6.1 Save scene

- 01) Press the P- or S-button for 1 second to activate the automatic mode.
- 02) The button clicks and will light up.
- 03) Scroll through the circular touchpad to choose the desired program or adjust the speed.
- 04) Press one of the figure buttons (1-4) for 2 seconds to store the scene.
- 05) All buttons will flash once to confirm the desired scene.
- 06) The desired scene is now stored including the preset built-in program, speed and brightness.
- 07) The device can store up to 4 scenes.

6.2 Playback scene

- 01) Press the P- or S-button for 1 second to activate the automatic mode.
- 02) The button clicks and will light up.
- 03) Press one of the figure buttons (1-4) to recall the desired scene.
- 04) The button will light up and the chosen scene will be played.

6.3 Lock/unlock

- 01) Press the P- and S-button simultaneously for 10 seconds.
- 02) The S-button is now locked, it is not possible to record a scene.
- 03) It remains possible to recall a scene with the figure buttons (1-4).
- 04) To unlock the S-button, press the P- and S-button simultaneously for 10 seconds.
- 05) All buttons will flash once.
- 06) The S-button is now unlocked, it is possible to record a scene again.

7. Button click

With this function you can turn on or turn off the button click.

- 01) To turn ON or turn OFF the button click, press all figure buttons (1-4) simultaneously.
- 02) All buttons flash simultaneously to confirm the setting.
- 03) If you choose to turn ON the button click, the click will disappear when you reach the minimum or maximum value by turning the circular touchpad.
- 04) If you choose to turn OFF the button click, all buttons will flash 3 times when you reach the minimum or maximum value by turning the circular touchpad.

8. Default settings

With this function you can reset the device to its default settings.

- 01) Press and hold down the P and B –button simultaneously for 10 seconds.
- 02) All buttons flash simultaneously to confirm resetting the device to its default settings.
- 03) All user settings will be deleted.
- 04) The fadetime for the color change and power on/off is now 2 seconds.
- 05) The recorded scenes will be deleted and replaced by default scenes.

9. Multiple devices

With this function you can connect multiple devices with each other.

- 01) Connect multiple devices with the Link IN/OUT terminals at the back of the device.
- 02) It is possible to connect up to 32 devices with each other.
- 03) You can send data from the current device to the other connected devices by pressing the P-, C-, B- and S-button simultaneously for 5 seconds.
- 04) All buttons flash simultaneously and the current device is ready to send the data.
- 05) Press the S-button to start sending the data to the connected devices.
- 06) During the sending the P-, C-, B- and S-button will light up in sequence.
- 07) It will take 10 seconds until the data is completely send to the other devices.
- 08) After the sending is done, all devices will return to the normal mode.

Maintenance

The operator has to make sure that safety-related and machine-technical installations are to be inspected by an expert after every year in the course of an acceptance test.

The operator has to make sure that safety-related and machine-technical installations are to be inspected by a skilled person once a year.

The following points have to be considered during the inspection:

- 01) All screws used for installing the device or parts of the device have to be tightly connected and must not be corroded.
- 02) There may not be any deformations on housings, fixations and installation spots.
- 03) The electric power supply cable must not show any damages or material fatigue.

The Domotion DLC-4 RGBW requires almost no maintenance. However, you should keep the unit clean. Wipe the cover with a damp cloth. Do not immerse in liquid. Wipe the unit clean with glass cleaner and a soft cloth. Do not use alcohol or solvents.

Troubleshooting

This troubleshooting guide is meant to help solve simple problems.

If a problem occurs, carry out the steps below in sequence until a solution is found. Once the unit operates properly, do not carry out following steps.

No Reaction fixture

If the DLC-4 does not operate properly, refer servicing to a technician.

Suspect two potential problem areas as: the power supply and the DLC-4.

- 01) Power supply. Check that the unit is correct connected to the power supply.
- 02) The DLC-4. Return the DLC-4 to your Artecta dealer.
- 03) If all of the above appears to be O.K., try the unit again.
- 04) If you are unable to determine the cause of the problem, do not open the DLC-4, as this may damage the unit and the warranty will become void.
- 05) Return the device to your Artecta dealer.

No Response to DMX

Response: Suspect the DMX cable or connectors, a controller malfunction, a light effect DMX card malfunction.

- 01) Check the DMX setting. Make sure that DMX addresses are correct.
- 02) Check the DMX cable: Unplug the unit; change the DMX cable; then reconnect to electrical power. Try your DMX control again.
- 03) Determine whether the controller or light effect is to blame. Does the controller operate properly with other DMX products? If not, take the controller in for repair. If it does, take the DMX cable and the light effect to a qualified technician.

Problem	Probable cause(s)	Solution
The unit does not function at all	No power to the unit	<ul style="list-style-type: none"> Check if the unit is connected to the power supply
	Bad cable connection	<ul style="list-style-type: none"> Inspect connections and cables. Correct poor connection. Repair or replace damaged cables.
Fixtures reset correctly, but all respond erratically or not at all to the controller	The controller is not connected.	<ul style="list-style-type: none"> Connect controller.
	4-pin DMX Out of the controller does not match DMX Out of the first fixture on the link (i.e. signal is reversed)	<ul style="list-style-type: none"> Install a phase reversing cable between the controller and the first fixture on the link
Fixtures reset correctly, but some respond erratically or not at all to the controller	Poor data quality	<ul style="list-style-type: none"> Check data quality. If much lower than 100 percent, the problem may be a bad data link connection, poor quality or broken cables, missing termination plug, or a defective fixture disturbing the link
	Bad data link connection	<ul style="list-style-type: none"> Inspect connections and cables. Correct poor connections. Repair or replace damaged cables
	Incorrect addressing of the fixtures	<ul style="list-style-type: none"> Check address setting
	One of the fixtures is defective and disturbs data transmission on the link	<ul style="list-style-type: none"> Bypass one fixture at a time until normal operation is restored: unplug both connectors and connect them directly together. Have the defective fixture serviced by a qualified technician
	3-pin XLR Out on the fixtures does not match (pins 2 and 3 reversed)	<ul style="list-style-type: none"> Install a phase-reversing cable between the fixtures or swap pin 2 and 3 in the fixture that behaves erratically
No light or LEDs cuts out intermittently	Fixture is too hot	<ul style="list-style-type: none"> Allow the fixture to cool down Clean the fan Turn up the air conditioning
	LEDs damaged	<ul style="list-style-type: none"> Disconnect the fixture and return it to your dealer
	The power supply settings do not match local AC voltage and frequency	<ul style="list-style-type: none"> Disconnect fixture. Check settings and correct if necessary

Product Specifications

Model:	Artecta Domotion DLC-4 RGBW
Input Voltage:	12-24 VDC
Power:	2A/kanal, total 8A max
Channels:	4
Dimming:	DMX
IP rating:	IP20
Protection class:	III
Dimensions:	85 x 85 x 15 mm (LxWxH)
Weight:	0,1 kg
Min. operating temperature t_a :	0°C
Max. operating temperature t_b :	40°C

Dimensions

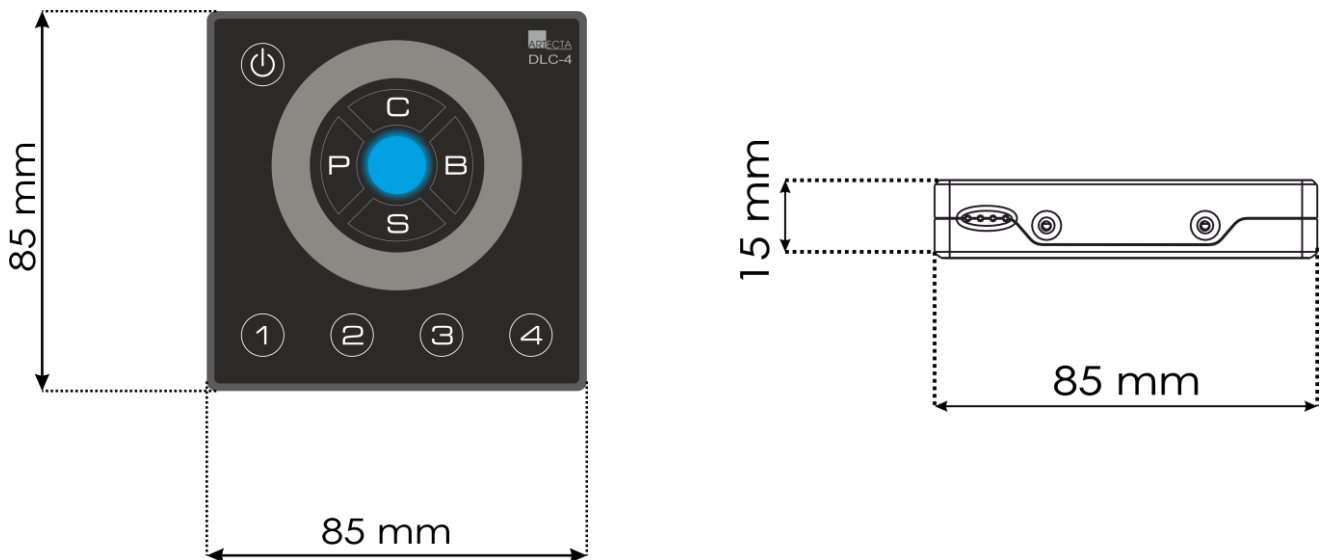

Design and product specifications are subject to change without prior notice.



Website: artecta.nl
 Email: service@highlite.nl



©2017 Artecta