

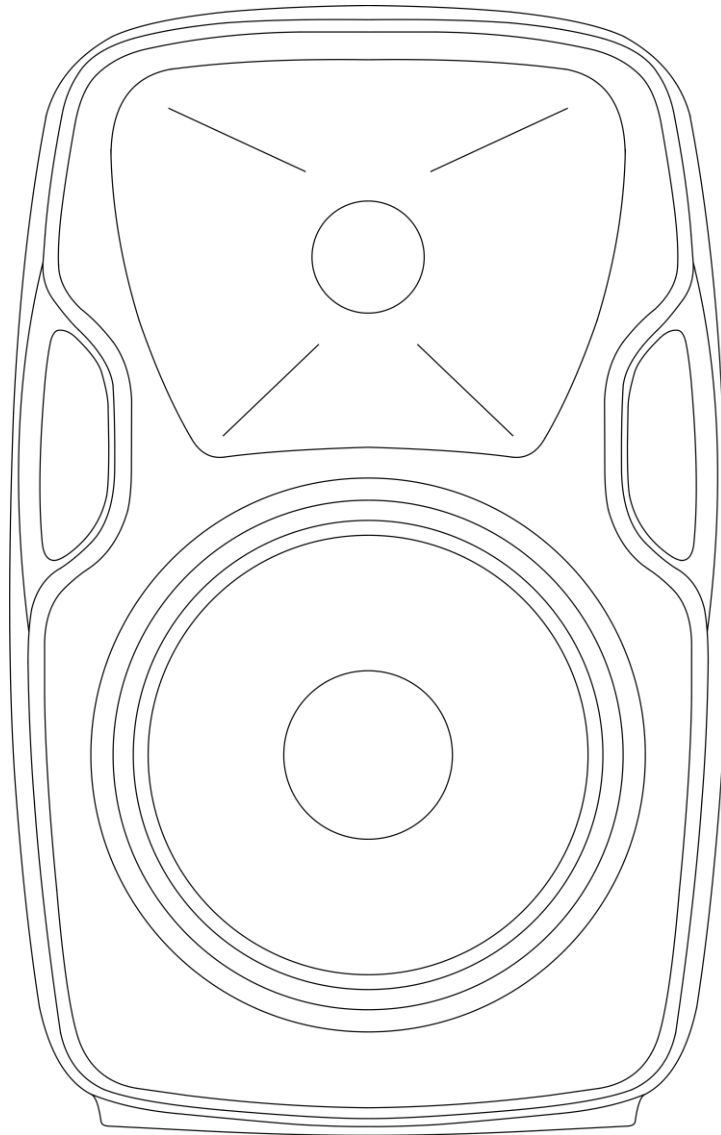

MANUAL



ENGLISH

Venga 12

V1

Ordercode: 920000

Table of contents

Warning	2
Safety Instructions	2
Operating Determinations	4
Connection with the mains	4
Return Procedure	4
Claims	4
Description of the device	5
Features	5
Overview	5
Names and Functions	6
Installation	8
Set Up and Operation	8
Connection	8
AC Power	8
Stand-by Mode	8
Control Modes	8
1. Tuner Mode	8
Auto Tuning	8
Tuning	8
Selecting Radio Stations	8
2. USB/SD mode	9
Selecting Tracks	9
Starting/Pausing Playback	9
Repeat Mode	9
3. Bluetooth Mode	10
Remote Control	11
1. Tuner Mode	11
Auto Tuning	11
Tuning	11
2. USB/SD mode	12
Selecting Tracks	12
Starting/Pausing Playback	12
Stopping Playback	12
3. Adjusting Volume	12
4. Equalizer Presets	12
Connection Example	13
Connection Cables	14
Maintenance	15
Replacing the Fuse	15
Troubleshooting	15
No Sound	15
Product Specifications	16
Notes	17

Warning

**For your own safety, please read this user manual carefully
before your initial start-up!**

**Unpacking Instructions**

Immediately upon receiving this product, carefully unpack the carton and check the contents to ensure that all parts are present, and have been received in good condition. Notify the dealer immediately and retain packing material for inspection if any parts appear damaged from shipping or the carton itself shows signs of mishandling. Save the carton and all packing materials. In the event that a fixture must be returned to the factory, it is important that the fixture be returned in the original factory box and packing.

Your shipment includes:

- Showgear Venga 12
- Remote control
- IEC power cable (1,5 m)
- User manual



CAUTION!
Keep this device away from rain and moisture!
Unplug mains lead before opening the housing!

**Safety Instructions**

Every person involved with the installation, operation and maintenance of this system has to:

- be qualified
- follow the instructions of this manual



CAUTION! Be careful with your operations.
**With a dangerous voltage you can suffer
a dangerous electric shock when touching the wires!**



Before your initial start-up, please make sure that there is no damage caused by transportation. Should there be any, consult your dealer and do not use the system.

To maintain perfect condition and to ensure a safe operation, it is absolutely necessary for the user to follow the safety instructions and warning notes written in this manual.

Please consider that damages caused by manual modifications to the system are not subject to warranty.

This system contains no user-serviceable parts. Refer servicing to qualified technicians only.

IMPORTANT:

The manufacturer will not accept liability for any resulting damages caused by the non-observance of this manual or any unauthorized modification to the system.

- Always disconnect power from the mains, when system is not used. Only handle the power cord by the plug. Never pull out the plug by tugging the power cord.
- Always operate the unit with the AC ground wire connected to the electrical system ground.
- Avoid flames and do not put close to flammable liquids or gases.

- Avoid ground loops! Always be sure to connect the power amps and the mixing console to the same electrical circuit to ensure the same phase!
- Avoid installing your equipment very near radio or TV sets, mobile phones, etc., as these can cause RF (radio frequency) interference.
- Before changing your grounds around, always turn your amplifiers down.
- Before connecting or disconnecting the power cord, make sure that the power switch is in the OFF position.
- Before switching on or off, make sure the sound system's amplifiers are off or turned down: this will avoid signal peaks, which are annoying and sometimes dangerous (particularly for speaker enclosures).
- Do not connect (parallel or series) an amplifier output with any other amplifier output.
- Do not connect this device to a dimmer pack.
- Do not drive the inputs with a signal level higher than required to drive the equipment to full output.
- Do not insert objects into air vents.
- Do not open this device. Risk: hazardous radiation exposure.
- Do not run the output of any amplifier channel, back into another channel's input.
- Do not switch the system on and off in short intervals, as this would reduce the system's life.
- Extreme frequency boosts in connection with a high input signal level may lead to overdriving your equipment. Should this occur, it is necessary to reduce the input signal level by using the INPUT control.
- For replacement use fuses of same type and rating only.
- If device is dropped or struck, disconnect mains power supply immediately. Have a qualified engineer inspect for safety before operating.
- If the system has been exposed to drastic temperature fluctuation (e.g. after transportation), do not switch it on immediately. The arising condensation water might damage your system. Leave the system switched off until it has reached room temperature.
- In system setup, the amplifier's output power must be 50%-100% more than the loaded loudspeakers' rated power.
- Make sure that the available voltage is not higher than stated on the rear panel.
- Make sure that the power cord is never crimped or damaged. Check the device and the power cord from time to time.
- Make sure that the signals into the mixer are balanced, otherwise hum could be created.
- Make sure that there is sufficient room on all sides of the system for air circulation.
- Make sure you do not use the wrong kind of cables or defective cables.
- Make sure you use DI boxes to balance unbalanced signals; All incoming signals should be clear
- Never let the power cord come into contact with other cables! Handle the power cord and all connections with the mains with particular caution!
- Never remove warning or informative labels from the unit.
- Never use anything to cover the ground contact.
- Only use device indoors, avoid contact with water or other liquids.
- Please turn off the power switch, when changing the power cord or signal cable, or select the input mode switch.
- Prevent distortion! Make sure that all components connected to the Venga have sufficient power rating. Otherwise distortion will be generated because the components are operated at their limits.
- Repairs, servicing and electric connection must be carried out by a qualified technician.
- Sometimes, when you want to send one signal to more than one amplifier, you should use a signal distributor.
- The best way (even if not always feasible) to avoid ground loops is to connect the electric ground of all the equipment to a single central point ("star" system). In this case, the central point can be the mixer.
- To avoid or solve hum and buzzing troubles, try different combinations of lifting grounds on units that are supplied with ground lift switches or make sure all chassis are connected to earth ground, either through the AC power cord ground or by the front panel rack mount screws.
- To emphasize a frequency range, you do not necessarily need to move its respective sliding control upwards; try lowering surrounding frequency ranges instead. This way, you avoid causing the next piece of equipment in your sound path to overdrive. You also preserve valuable dynamic reserve ("headroom").
- When connecting the other parts of your sound system, watch out for the so-called "ground loops".
- WARRANTY: Till one year after date of purchase.

Operating Determinations

This system is not designed for permanent operation. Consistent operation breaks will ensure that the system will serve you for a long time without defects.

If this system is operated in any other way, than the one described in this manual, the product may suffer damages and the warranty becomes void.

Any other operation may lead to dangers like short-circuit, burns, electric shock, etc.

You endanger your own safety and the safety of others !

Improper installation can cause serious damage to people and property !

Connection with the mains

Connect the device to the mains with the power-plug.

Always pay attention, that the right color cable is connected to the right place.

International	EU Cable	UK Cable	US Cable	Pin
L	BROWN	RED	YELLOW/COPPER	FASE
N	BLUE	BLACK	SILVER	NULL
	YELLOW/GREEN	GREEN	GREEN	EARTH

Make sure that the device is always connected properly to the earth!

Improper installation can cause serious damage to people and property!

 **Return Procedure** 

Returned merchandise must be sent prepaid and in the original packing, call tags will not be issued. Package must be clearly labeled with a Return Authorization Number (RMA number). Products returned without an RMA number will be refused. Highlite will not accept the returned goods or any responsibility. Call Highlite 0031-455667723 or mail aftersales@highlite.com and request an RMA prior to shipping the fixture. Be prepared to provide the model number, serial number and a brief description of the cause for the return. Be sure to properly pack fixture, any shipping damage resulting from inadequate packaging is the customer's responsibility. Highlite reserves the right to use its own discretion to repair or replace product(s). As a suggestion, proper UPS packing or double-boxing is always a safe method to use.

Note: If you are given an RMA number, please include the following information on a piece of paper inside the box:

- 01) Your name
- 02) Your address
- 03) Your phone number
- 04) A brief description of the symptoms

Claims

The client has the obligation to check the delivered goods immediately upon delivery for any shortcomings and/or visible defects, or perform this check after our announcement that the goods are at their disposal. Damage incurred in shipping is the responsibility of the shipper; therefore the damage must be reported to the carrier upon receipt of merchandise.

It is the customer's responsibility to notify and submit claims with the shipper in the event that a fixture is damaged due to shipping. Transportation damage has to be reported to us within one day after receipt of the delivery.

Any return shipment has to be made post-paid at all times. Return shipments must be accompanied with a letter defining the reason for return shipment. Non-prepaid return shipments will be refused, unless otherwise agreed in writing.

Complaints against us must be made known in writing or by fax within 10 working days after receipt of the invoice. After this period complaints will not be handled anymore.

Complaints will only then be considered if the client has so far complied with all parts of the agreement, regardless of the agreement of which the obligation is resulting.

Description of the device

Features

The Venga 12 is a versatile active speaker. It is compact, rough and offers a dynamic and powerful sound. Its built-in MP3 player allows you to play songs directly from your USB/SD card. The built-in FM tuner lets you stay tuned to your favorite radio channel.

The Venga 12 offers a possibility to connect your microphone or any other external line signal such as a laptop, CD player, MP3 player and many others.

- Woofer size: 12"
- Horn driver: 1"
- Horn coverage: 90° H x 45° V
- Continuous power: 100W
- Frequency response: 30Hz - 18kHz
- SPL @1m: 90dB +/- 2dB
- Power supply: 230V AC, 50Hz
- Tuner function
- USB/SD/Bluetooth function
- Connections: RCA AUX IN/OUT, XLR mic 1 IN, 6,3 mm jack mic 2 IN
- Housing: Plastic cabinet, rubber feet, ergonomic handle
- Color: Black
- Mounting: 35 mm pole mount
- Fuse: F1,6AL/250V
- Dimensions: 380 x 295 x 585 mm (LxWxH)
- Weight: 9 kg

Overview

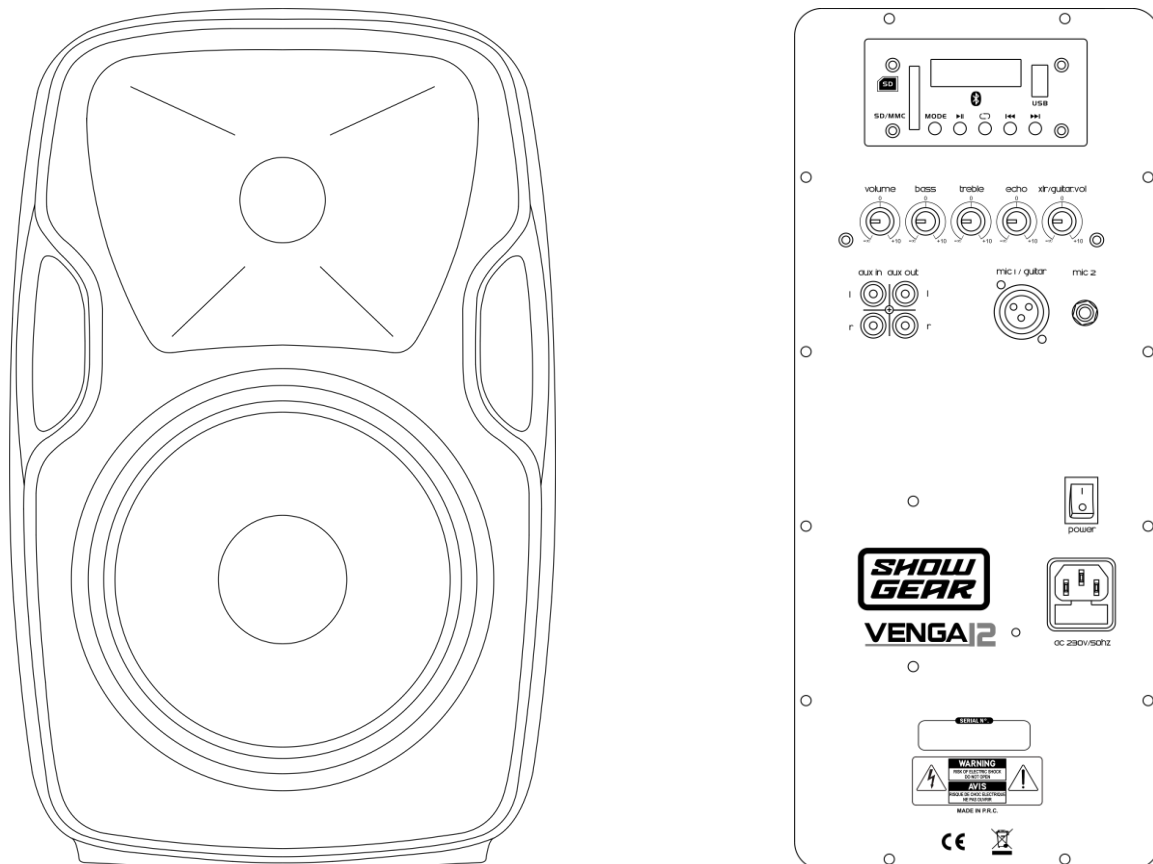

Fig. 01

Names and Functions

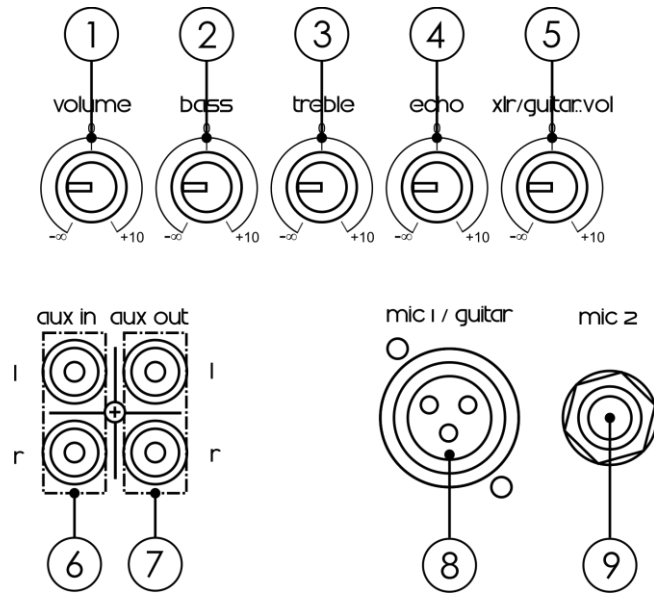

Fig. 02

- ① **Volume control**
Turn the control to set the volume.
- ② **Bass control**
Turn the control to set the bass level.
- ③ **Treble control**
Turn the control to set the treble level.
- ④ **Echo control**
Turn the control to set the echo level.
- ⑤ **Guitar/microphone volume**
Turn the control to set the volume of your guitar/microphone.
- ⑥ **RCA AUX unbalanced IN**
Connect a line level device.
- ⑦ **RCA AUX unbalanced OUT**
Connect a recorder or a sound system.
- ⑧ **XLR connector – mic 1/guitar IN**
Connect a guitar/microphone.
- ⑨ **6,3 mm jack connector – mic 2 IN**
Connect a microphone.

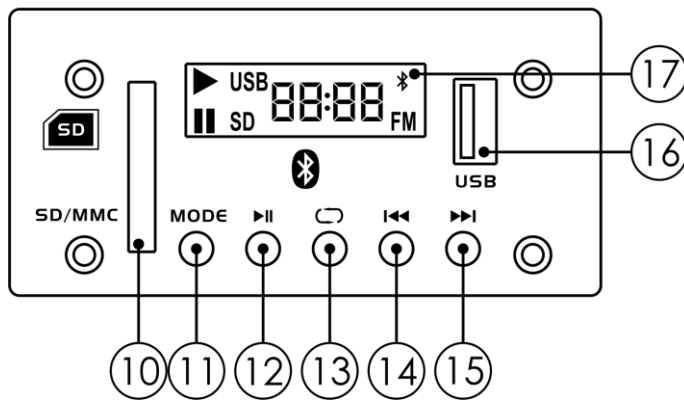

Fig. 03

- ⑩ **SD card slot**
Insert an SD card, containing music files (mp3/wav).
- ⑪ **MODE button**
Press the button to select one of the 4 operation modes: Tuner (FM), USB, SD, Bluetooth.
- ⑫ **Play/Pause button**
Press the button to start/pause playback (USB/SD mode) or start auto tuning (Tuner mode).
- ⑬ **Repeat button**
Press the button to set the desired repeat mode (USB/SD mode).
- ⑭ **Seek/skip backward button**
Press the button to skip tracks backward. Press and hold down the button to rewind the currently selected track (USB/SD mode) or tune to the previous strongest station (Tuner mode). Repeatedly press the button to select the previous track (USB/SD mode) or the previous radio station (Tuner mode).
- ⑮ **Seek/skip forward button**
Press the button to skip tracks forward. Press and hold down the button to fast forward the currently selected track (USB/SD mode) or tune to the next strongest station (Tuner mode). Repeatedly press the button to select the next track (USB/SD mode) or the next radio station (Tuner mode).
- ⑯ **USB A connector IN**
Connect a USB flash drive, containing music files (mp3/wav).
- ⑰ **LED display**

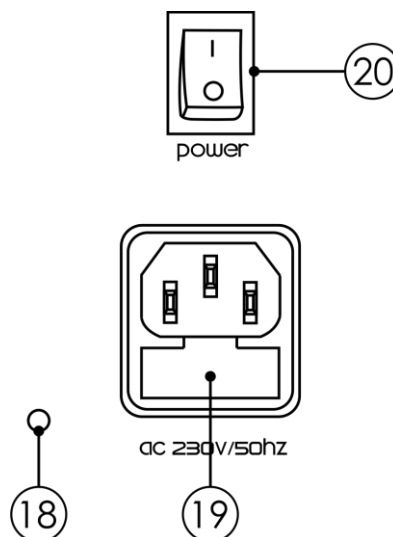

Fig. 04

- ⑱ **Ground/earth connection**
- ⑲ **IEC 230V AC power connector + Fuse F1,6AL/250V**
- ⑳ **Power switch ON/OFF**

Installation

Remove all packing materials from the Venga 12. Check that all foam and plastic padding is removed. Connect all cables.

**Always disconnect from electric mains power supply before cleaning or servicing.
Damages caused by non-observance are not subject to warranty.**

Set Up and Operation

Before plugging the unit in, always make sure that the power supply matches the product specification voltage. The power supply is printed on the back of the device.
Do not attempt to operate an 115V specification product on 230V power, or vice versa.

Connection

- 01) Press the **power switch (20)** to turn off the device.
- 02) Connect the Venga to the other devices which you plan to use.

CAUTION: Make sure that the power is off, when connecting the cables.

AC Power

- 01) Make sure the **power switch (20)** is in off position.
- 02) Connect the power cable.
- 03) Press the **power switch (20)** to turn the device on.

Stand-by Mode

- 01) When the device is on, press and hold down the **MODE button (11)** for 2 seconds. The device will enter stand-by mode.
- 02) Repeat step 1 to switch the device on again.

Control Modes

1. Tuner Mode

- 01) Press the **MODE button (11)** until the display shows FM.

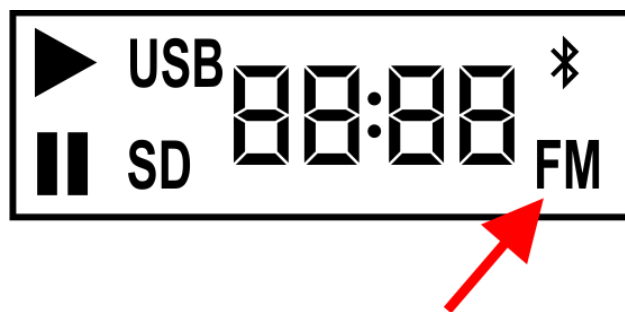

Auto Tuning

- 01) Press and hold down the ►|| button for 3 seconds. The device will initiate auto tuning, which will stop every time a strong radio signal is found and stored.
- 02) It is also possible to stop auto tuning manually. In order to do so, press the ►|| button.

Tuning

- 01) Press and hold down the ◀◀ or ▶▶ button for 3 seconds. The device will initiate a backward or forward tuning and will stop every time a strong radio signal is found.
- 02) To manually stop tuning, press the ►|| button.

Selecting Radio Stations

While in Tuner mode, press the ◀◀ and ▶▶ buttons to toggle through the programmed radio stations.

2. USB/SD mode

- 01) Press the **MODE button (11)** until the display shows USB or SD, depending on the preferred music source.

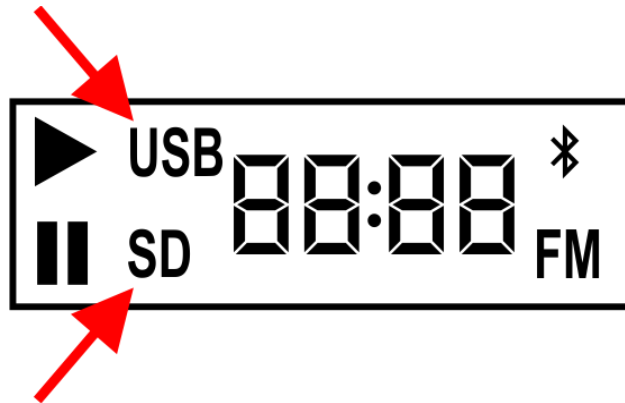

- 02) Insert a USB flash drive into the **USB slot (16)** or an SD card into the **SD slot (10)**.
 03) The device will now search for the supported music files (mp3/wav).

Selecting Tracks

- 01) Press the **⏮** button to skip to the previous track or restart the currently selected track.
 02) Press the **⏭** button to skip to the next track.
 03) Playback will begin automatically, once a new track has been selected.

Starting/Pausing Playback

- 01) Press the **▶||** button to start playback.
 02) Press the button again to pause playback.
 03) Press the button again to resume playback.

Repeat Mode

- 01) While in USB or SD mode, press the **↺↻** button to select the desired repeat mode.
 02) There are 4 available repeat modes:

- ONE** Single track: repeats a single track several times
- rAn** Random: repeats all tracks in random order
- ALL** All: repeats all tracks
- FOLD** Folder: repeats the currently selected folder

3. Bluetooth Mode

01) Press the **MODE button (11)** until the display shows:



- 02) The Bluetooth logo will be blinking.
- 03) Activate Bluetooth function on your external device, search for available Bluetooth devices and pair your external device with the Venga speaker (device name: **Bluetooth**).
- 04) The Bluetooth logo on the display will now stop blinking and will be continuously on. It means that the Venga speaker and your Bluetooth device have been successfully paired.
- 05) Play music on your Bluetooth device and it will be audible on the Venga speaker.
- 06) Only one Bluetooth device can be paired with one Venga speaker.

Tips For Achieving Maximum Performance

- Keep the distance between the paired Bluetooth devices as short as possible.
- Avoid placing the Bluetooth devices near metal surfaces and obstructions.
- Perform a walk-through before performance or presentation. If dead spots are found, adjust the location of the Bluetooth devices. If dead spots remain, mark the dead spots and avoid them.

Remote Control

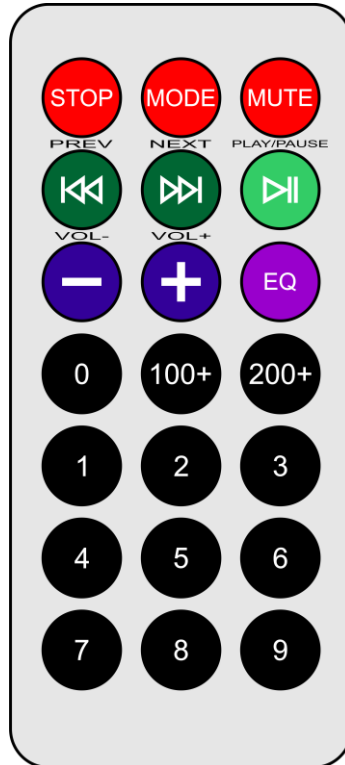

Button	Function	Description
	Stop	Press the button to stop playback (USB/SD mode).
	Mode	Press the button to toggle through the available operation modes.
	Mute	Press the button to mute the output.
	Seek backward/forward	Press the buttons to search for radio stations (Tuner mode) or rewind/fast forward tracks (USB/SD mode).
	Play/Pause	Press the button to start/pause playback.
	Volume +/-	Press the buttons to increase/decrease volume (0-15).
	Equalizer Presets	Press the button to toggle through the available equalizer presets (USB/SD mode).
	Track buttons 100+ & 200+	Press the buttons to choose tracks with a number higher than 100 or 200 (USB/SD mode).
	Track buttons 0-99	Press the buttons to choose tracks from 01-99 (USB/SD mode).

1. Tuner Mode

Auto Tuning







- 01) Press and hold down the button for 3 seconds. The device will initiate auto tuning, which will stop every time a strong radio signal is found and stored.
- 02) It is also possible to stop auto tuning manually. In order to do so, press the button.

Tuning

- 01) Press and hold down the buttons for 3 seconds. The device will initiate a backward or forward tuning and will stop every time a strong radio signal is found.
- 02) To manually stop tuning, press the button.

2. USB/SD mode

Selecting Tracks

- 01) Press the  button to skip to the previous track or restart the currently selected track.
- 02) Press the  button to skip to the next track.
- 03) Playback will begin automatically, once a new track has been selected.
- 04) If you want to select a particular track, you can insert its number by pressing the   buttons (tracks 01-99).
- 05) If you want to select a track from 100 onwards (e.g. track #124), press the  button and then buttons 2 and 4.
- 06) Similarly, in order to select a track from 200 onwards (e.g. track #217), first press the  button and then buttons 1 and 7.



Starting/Pausing Playback

- 01) Press the  button to start playback.
- 02) Press the button again to pause playback.
- 03) Press the button again to resume playback.

Stopping Playback

- 01) Press the  button to stop playback.

3. Adjusting Volume

- 01) Press the   buttons to increase/decrease the volume. The adjustment range is between 0-15, from mute to loud.

4. Equalizer Presets

- 01) While in USB/SD mode, press the  button to toggle through the following available equalizer presets:

	Pop
	Rock
	Jazz
	Classical
	Country
	Bass
	Normal

Connection Example

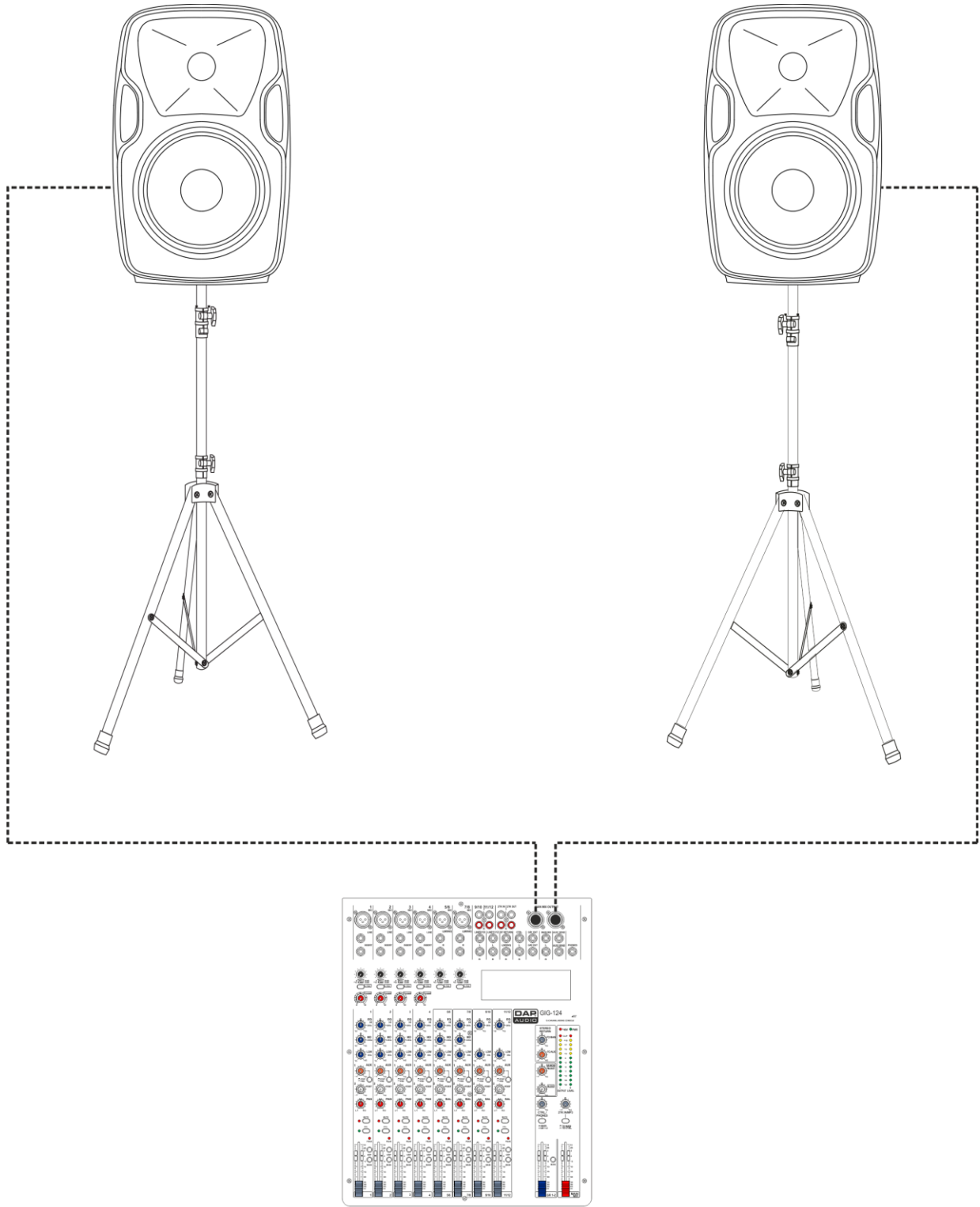

D2284 - GiG-124c

Fig. 05

Connection Cables

Take care of your cables, always holding them by the connectors and avoiding knots and twists when coiling them: This gives the advantage of increasing their life and reliability. Periodically check your cables. A great number of problems (faulty contacts, ground hum, discharges, etc.) are caused entirely by using unsuitable or faulty cables.

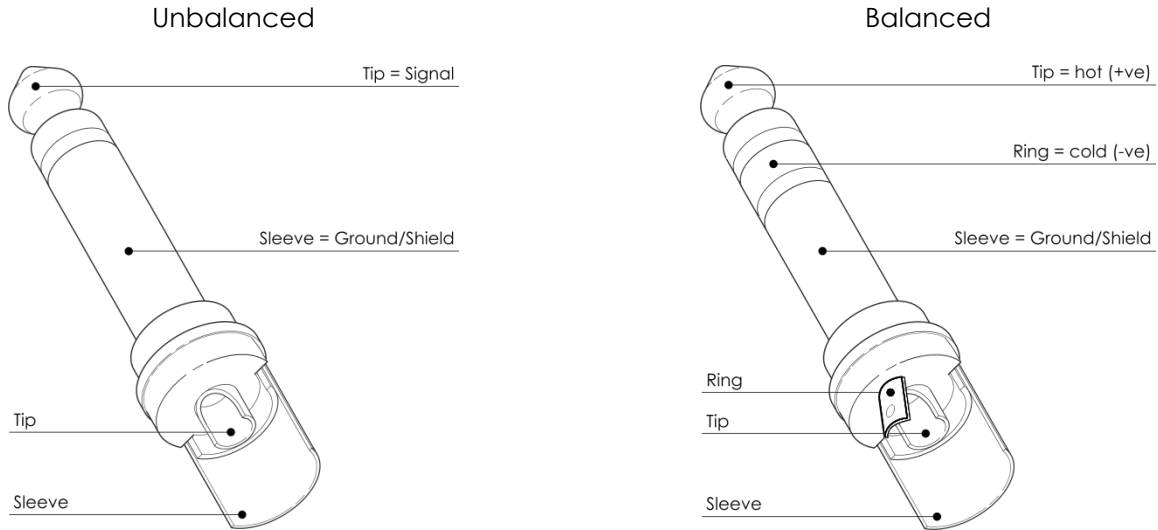

For these applications the unit provides 1/4" TRS and XLR connectors to easily interface with most professional audio devices. Follow the configuration examples below for your particular connection.

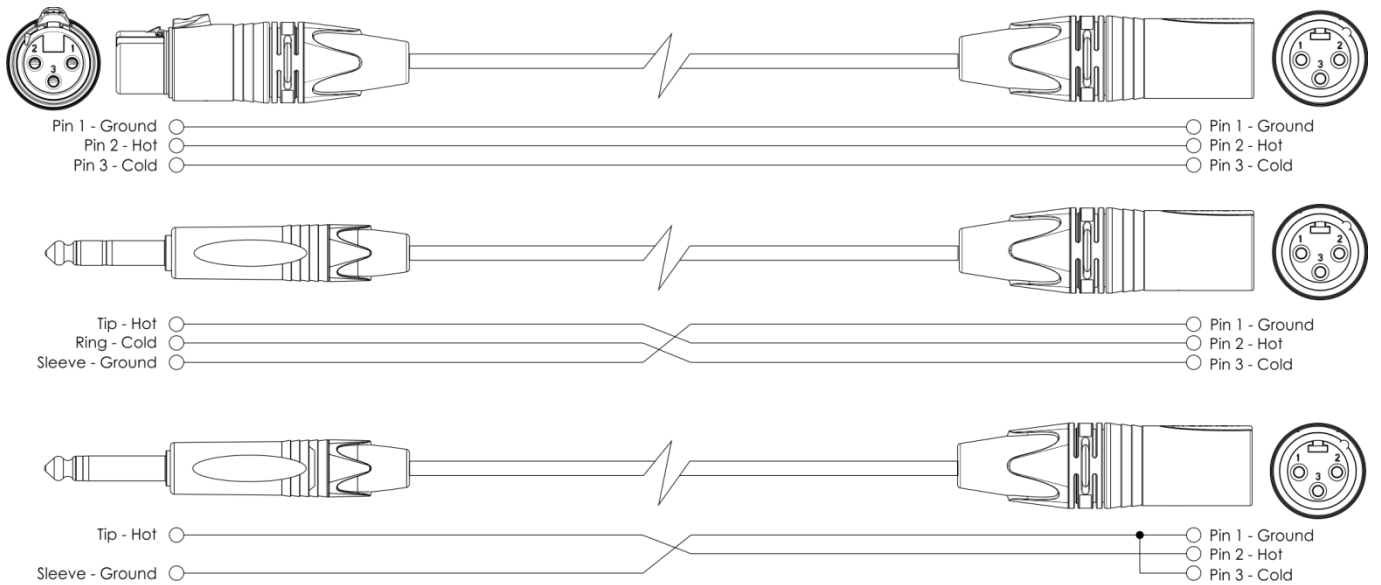

Maintenance

The Showgear Venga 12 requires almost no maintenance.

However, you should keep the unit clean.

Disconnect the mains power supply, and then wipe the cover with a damp cloth. Do not immerse in liquid. Do not use alcohol or solvents.

Keep connections clean. Disconnect electric power, and then wipe the audio connections with a damp cloth. Make sure connections are thoroughly dry before linking equipment or supplying electric power.

Replacing the Fuse

Power surges, short-circuit or inappropriate electrical power supply may cause a fuse to burn out. If the fuse burns out, the product will not function whatsoever. If this happens, follow the directions below.

01) Unplug the unit from electric power source.

02) Insert a screwdriver into the slot in the fuse cover. Gently pry up the fuse cover. The fuse will come out.

03) Remove the used fuse. If brown or unclear, it is burned out.

04) Insert the replacement fuse into the holder where the old fuse was. Reinsert the fuse cover. Be sure to use a fuse of the same type and specification. See the product specification label for details.

Troubleshooting

No Sound

Always check if all the cables and cords are connected. Always turn off power to the area before checking the wires, to prevent electric shock.

If everything works properly and there is still no sound, revisit the manufacturer's instructions to make sure they were followed during installation. If everything was installed correctly and there is still no sound, you may want to consider bringing in a professional to take a look at your speaker.

If the speaker does not operate properly, refer servicing to a technician.

Suspect three potential problem areas as: the power supply, the speaker, the fuse.

01) Power supply. Check if the unit is plugged into an appropriate power supply.

02) The speaker. Return the Venga to your Showgear dealer.

03) The fuse. Replace the fuse. See page 15 for replacing the fuse.

04) If all of the above appears to be O.K., plug the unit in again.

05) If you are unable to determine the cause of the problem, do not open the Venga, as this may damage the unit and the warranty will become void.

06) Return the device to your Showgear dealer.

Product Specifications

Power supply:	230V AC, 50Hz
Woofers size:	12"
Horn driver:	1"
Horn coverage:	90° H x 45° V
Continuous power:	100W
Frequency response:	30Hz - 18kHz
SPL @1m:	90dB +/- 2dB
Connections:	RCA AUX IN/OUT, XLR mic 1 IN, 6,3 mm jack mic 2 IN
Housing:	Plastic cabinet, rubber feet, ergonomic handle
Color:	Black
Mounting:	35 mm pole mount
Fuse:	F1,6AL/250V
Dimensions:	380 x 295 x 585 mm (LxWxH)
Weight:	9 kg

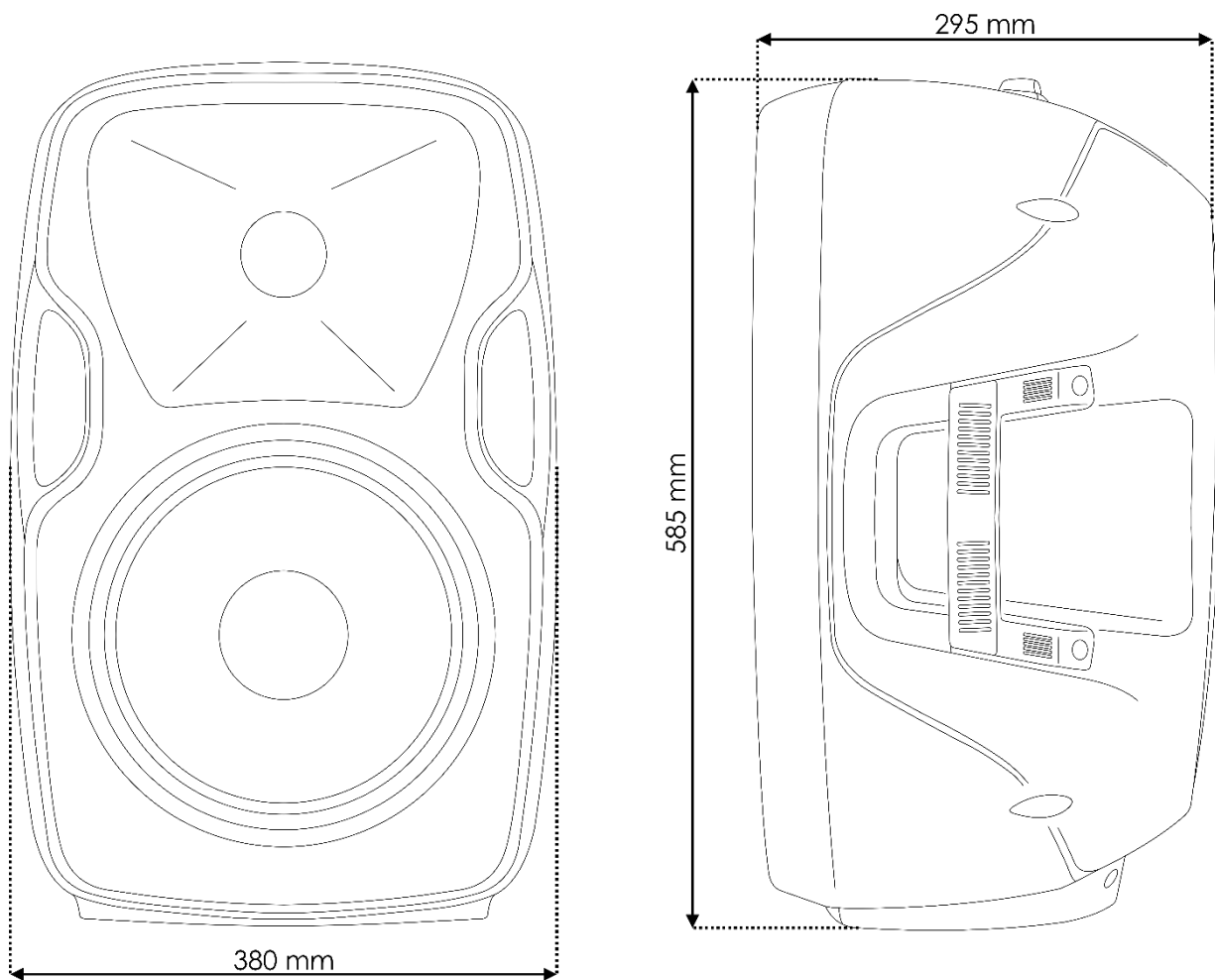

Design and product specifications are subject to change without prior notice.



Email: service@highlite.com



©2018 Showgear