

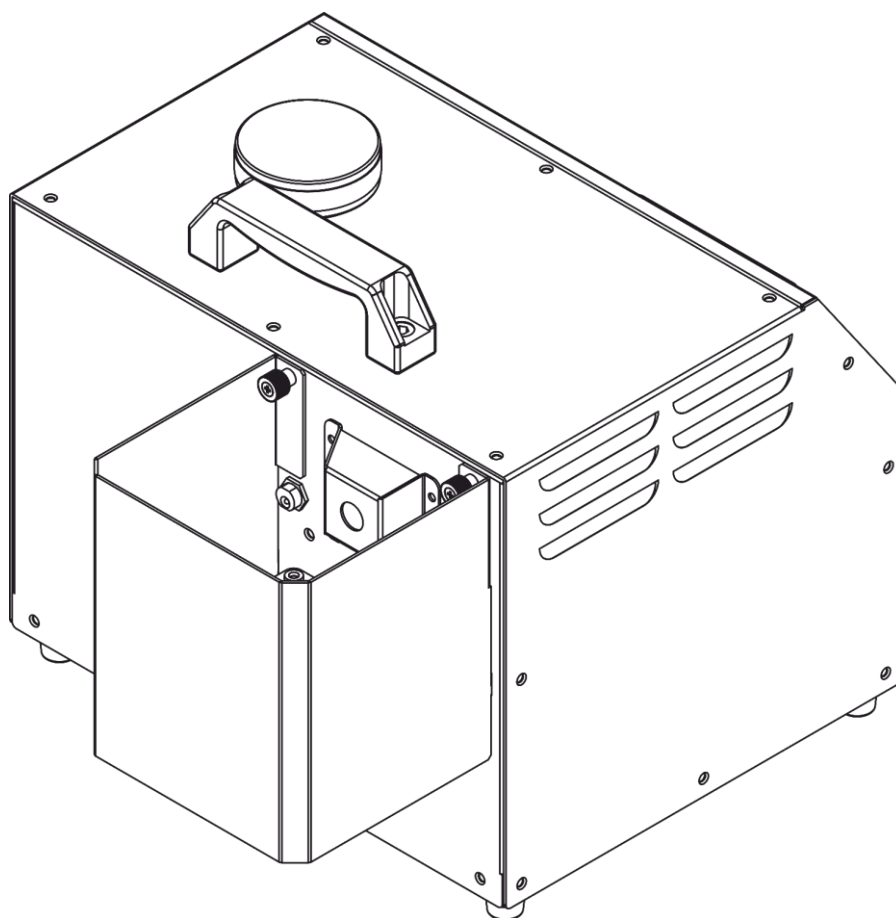

**MANUAL**



**ENGLISH**

**Mistique**

**V1**

**Ordercode: 60769**

## Table of contents

<b>Warning</b> .....	3
Safety Instructions .....	3
CO <sub>2</sub> Use .....	5
Operating Determinations .....	6
Return Procedure .....	7
Claims .....	7
<b>Description of the device</b> .....	8
Frontside .....	9
Backside .....	10
<b>Installation</b> .....	11
<b>Set Up and Operation</b> .....	12
Remove cover and fan to change output direction .....	12
Start up .....	13
Control Modes .....	15
One Mistique (Stand-alone) .....	15
Multiple Mistiques (DMX Control) .....	15
Fixture Linking .....	17
Data Cabling .....	17
Control Panel .....	18
Control Mode .....	18
DMX Addressing .....	18
Menu Overview .....	19
Main Menu Options .....	23
Status Menu .....	24
1. Timer 1 .....	25
1.1 Interval .....	25
1.2 Duration .....	26
1.3 Output Level .....	26
1.4 Fan Level .....	27
2. Timer 2 .....	27
3. DMX Channel .....	28
3.1 Address .....	28
3.2 Channel Mode .....	29
3.3 Link Mode .....	30
3.4 Wireless Mode .....	30
4. Power Off .....	31
5. Manual .....	31
5.1 Output Level .....	32
5.2 Fan Level .....	32
6. Clean .....	33
7. Heater .....	33
8. Menu .....	35
8.1 DMX Setup .....	35
8.1.1 Address .....	35
8.1.2 Channel Mode .....	36
8.1.3 Link Mode .....	37
8.1.4 Wireless Mode .....	37
8.2 Information .....	38
8.2.1 Software Version .....	38
8.2.2 Wireless Signal .....	39
8.2.3 Temperature .....	40
8.2.4 Pressure .....	40
8.2.5 Operating Hours .....	41
8.3 Setting .....	41

8.3.1 LCD Backlight .....42  
8.3.2 Auto Start .....42  
8.3.3 Factory Reset.....43  
8.3.4 Language .....44  
8.3.5 Software Update .....45  
8.3.6 Keypad Sound .....46  
DMX Channels .....47  
    1 channel .....47  
    3 channels .....47  
    5 channels .....47  
**Maintenance** .....48  
    Automatic Cleaning Procedure .....48  
    Automatic Protection Mechanism .....48  
    Fan Cleaning .....48  
    O-Ring Cleaning.....49  
    Replacing a Fuse .....49  
**Troubleshooting** .....50  
    Message List of Errors .....50  
**Product Specification** .....51  
**Dimensions**.....52  
**Notes** .....53

**Warning**

**For your own safety, please read this user manual carefully  
before your initial start-up!**

**Unpacking Instructions**

Immediately upon receiving this product, carefully unpack the carton and check the contents to ensure that all parts are present and have been received in good condition. Notify the dealer immediately and retain packing material for inspection if any parts appear damaged from shipping or the carton itself shows signs of mishandling. Save the carton and all packing materials. In the event that a fixture must be returned to the factory, it is important that the fixture be returned in the original factory box and packing.

**Your shipment includes:**

- Mistique
- True1 pro power cable (1,5 m)
- User manual

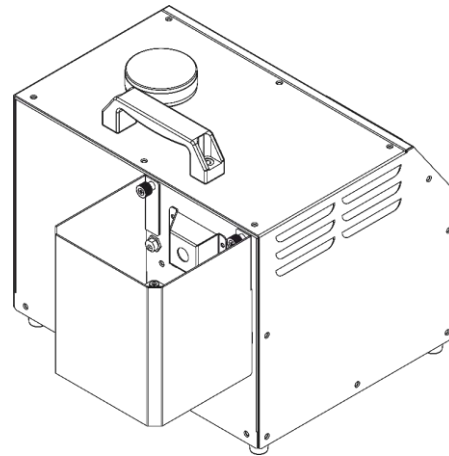

**CAUTION!**  
**Keep this device away from rain and moisture!**  
**Unplug mains lead before opening the housing!**

**Safety Instructions**

Every person involved with the installation, operation and maintenance of this device has to:

- be qualified
- follow the instructions of this manual



**CAUTION! Be careful with your operations.**  
**With a dangerous voltage you can suffer  
a dangerous electric shock when touching the wires!**



Before your initial start-up, please make sure that there is no damage caused by transportation. Should there be any, consult your dealer and do not the device.

To maintain perfect condition and to ensure a safe operation, it is absolutely necessary for the user to follow the safety instructions and warning notes written in this manual.

Please consider that damages caused by manual modifications to the device are not subject to warranty.

This device contains no user-serviceable parts. Refer servicing to qualified technicians only.

**IMPORTANT:**

The manufacturer will not accept liability for any resulting damages caused by the non-observance of this manual or any unauthorized modification to the device.

- Never let the power cord come into contact with other cables! Handle the power cord and all connections with the mains with particular caution!
- Always disconnect power from the mains, when device is not used or before cleaning ! Only handle the power cord by the plug. Never pull out the plug by tugging the power cord.
- Never remove warning or informative labels from the unit.
- Never use anything to cover the ground contact.
- Never aim the output nozzle directly at people.
- Never aim the output nozzle at open flames.
- Never add flammable liquids of any kind (oil, gas, perfume) to the haze liquid.
- Never drink haze liquid. If it is ingested, call a doctor immediately. If haze liquid comes in contact with skin or eyes, rinse thoroughly with water.
- Never lock haze-filled rooms. Risk: panic among the locked persons!
- Never use the device permanently! The output should be active only for short periods of time.
- Do not insert objects into air vents.
- Do not open the device and do not modify the device.
- Do not connect this device to a dimmerpack.
- Do not switch the device on and off in short intervals, as this would reduce the device's life.
- Do not touch the hazer output bare-handed during its operation (output becomes very hot).
- Do not shake the device. Avoid brute force when installing or operating the device.
- Only use device indoors, avoid contact with water or other liquids.
- Only use haze in well ventilated rooms.
- Only use the high-quality MHL-hazer liquid, recommended by your dealer (ordercodes: [60569](#)). Other haze liquids may cause poor effect.
- Avoid flames and do not put close to flammable liquids or gases.
- Always make sure there is sufficient liquid in the haze liquid tank.
- Always allow free air space of at least 50 cm around the sides and top of the unit.
- Always allow free air space of at least 50 cm around the unit for ventilation.
- Always disconnect device from the CO<sub>2</sub> cylinder and the hose, when device is not used or before cleaning! Only handle the CO<sub>2</sub> hose with care. Never pull out the CO<sub>2</sub> hose by tugging.
- Make sure that the device is not exposed to extreme heat, moisture or dust.
- Make sure that all the required safety devices are in good condition and function properly.
- Make sure that the CO<sub>2</sub> hose is never crimped or damaged. Check the device and the CO<sub>2</sub> hose from time to time.
- If text and/or icons are missing, damaged or illegible on the Mistique, they should be replaced
- Always drain tank before shipping or otherwise transporting this unit.
- Always keep tank cap closed while operating.
- Always keep the haze machine upright.
- Always unplug the Mistique before filling its tank.
- For adult use only. Haze machine must be installed out of the reach of children. Never leave the unit running unattended. Leave the grid guarding the nozzle in place if the machine is to be used in the presence of children
- Always keep the nozzle at least 50 cm away from contact with anything, while in operation.
- Make sure that the available voltage is not higher than stated on the rear panel.
- Make sure that the power cord is never crimped or damaged. Check the device and the power-cord from time to time.
- Make sure that the core diameter of extension cords and power cords is sufficient for the required power consumption of the device.
- The cable insert or the female part in the device must never be strained. There must always be sufficient cable to the device. Otherwise, the cable may be damaged which may lead to deadly electrical shocks.
- If the external cable is damaged, it has to be replaced by a qualified technician.
- If device is dropped or struck, disconnect mains power supply immediately. Have a qualified engineer inspect for safety before operating.

- If the device has been exposed to drastic temperature fluctuation (e.g. after transportation), do not switch it on immediately. The arising condensation water might damage your device. Leave the device switched off until it has reached room temperature.
- If the Mistique fails to work properly, discontinue use immediately. Drain all haze liquid from the tank, pack the unit securely (preferably in the original packing material), and return it to your Showtec dealer for service.
- For replacement use fuses of same type and rating only.
- The haze vapour at the point of release is under pressure and is extremely hot.
- The output nozzle becomes very hot during operation (300°C). Keep flammable materials at least 50 cm away from the nozzle.
- The use of haze-fluid is only allowed for adults.
- In dense, haze-saturated surroundings, the oxygen portion is substantially reduced!
- The haze density must be portioned in a way that the visibility of at least 5 m is preserved - Danger of anxiety state due to missing orientation!
- The user is responsible for correct positioning and operating of the Mistique. The manufacturer will not accept liability for damages caused by the misuse or incorrect installation of this device.
- Every haze-filled room must be overseen by a skilled person.
- Allow time to cool down, before cleaning or servicing.
- Provide sufficient lighting of the surroundings when installing the device.
- The user is responsible for correct positioning and operating of the Mistique. The manufacturer will not accept liability for unsafe situations, accidents, damages caused by:
  - The misuse or incorrect installation of this device.
  - Ignoring warnings or instructions as shown in this manual.
  - Using the Mistique for purposes or conditions other than specified in this manual.
  - Changes to the Mistique. This includes the use of other than original spare parts.
  - Inadequate maintenance.
  - The unauthorized removal of safety symbols, safety covers and / or guards.
  - The improper use of the Mistique.
- Repairs, servicing and electric connection must be carried out by a qualified technician.
- WARRANTY: Till one year after date of purchase.



### CAUTION!

**Do not perform any repairs on your own!**  
**If in doubt, always contact [service@highlite.com](mailto:service@highlite.com)!**



### CAUTION!

**Follow all warnings and safety instructions during installation/operation!**  
**Non-observance could lead to severe injuries or even death !!!**



## CO<sub>2</sub> Use

The Mistique uses liquid or gaseous CO<sub>2</sub> as input. The application of CO<sub>2</sub> involves serious risks. Make sure that you are well informed on these risks before installation and/or operation. Always use approved CO<sub>2</sub> cylinders, hoses and connections. Always consult your CO<sub>2</sub> supplier for regulations and instructions on safe installation and use.

Showtec is not liable for unsafe situations, accidents and damages that are the result of incorrect working with CO<sub>2</sub> gas and CO<sub>2</sub> cylinders.

 Inadequate installation and/or operation of a CO<sub>2</sub> powered machine and CO<sub>2</sub> cylinders can lead to death or serious injury. Always follow the instructions from this manual, from your CO<sub>2</sub> supplier and from local authorities.

## Operating Determinations

- This device is not designed for permanent operation. Consistent operation breaks will ensure that the device will serve you for a long time without defects.
- The maximum ambient temperature  $t_a = 40^\circ\text{C}$  must never be exceeded.
- The relative humidity must not exceed 50 % with an ambient temperature of  $40^\circ\text{C}$ .
- If this device is operated in any other way, than the one described in this manual, the product may suffer damages and the warranty becomes void.
- Any other operation may lead to dangers like short-circuit, burns, electric shock, crash etc.



We presume that you, your employees and others who come into contact with the Mistique are familiar with how the machine must be dealt with. This includes the correct use, maintenance and repair of Mistique as described in this user manual. The employees should be familiar with the use of machines through training and/or experience.



*Improper installation can cause serious damage to people and property !*

*You endanger your own safety and the safety of others!*

Showtec excludes liability for unsafe situations, accidents and damage that are the result of:

- Disregard for the warnings or regulations as set out on the Mistique or in this manual.
- Use for other purposes or under other circumstances than those set out in this documentation.
- Alterations to the Mistique. This also includes the use of replacement parts other than the original ones.
- Insufficient maintenance.
- Unauthorised removal of safety caps and/or safeguards.
- Incompetent operation of the machine.

Showtec is not liable for any consequential loss in the event of an Mistique breakdown.

**This user manual has been drawn up with the utmost care. Showtec cannot be held responsible for any mistakes made in this publication or for any consequences thereof.**

## Connection with the mains

Connect the device to the mains with the power-plug.

Always pay attention, that the right color cable is connected to the right place.

International	EU Cable	UK Cable	US Cable	Pin
L	BROWN	RED	YELLOW/COPPER	PHASE
N	BLUE	BLACK	SILVER	NEUTRAL
	YELLOW/GREEN	GREEN	GREEN	PROTECTIVE GROUND

Make sure that the device is always connected properly to the earth!

*Improper installation can cause serious damage to people and property!*



## Return Procedure



Returned merchandise must be sent prepaid and in the original packing, call tags will not be issued. Package must be clearly labeled with a Return Authorization Number (RMA number). Products returned without an RMA number will be refused. Highlite will not accept the returned goods or any responsibility. Call Highlite 0031-455667723 or mail [aftersales@highlite.com](mailto:aftersales@highlite.com) and request an RMA prior to shipping the fixture. Be prepared to provide the model number, serial number and a brief description of the cause for the return. Be sure to properly pack fixture, any shipping damage resulting from inadequate packaging is the customer's responsibility. Highlite reserves the right to use its own discretion to repair or replace product(s). As a suggestion, proper UPS packing or double-boxing is always a safe method to use.

**Note: If you are given an RMA number, please include the following information on a piece of paper inside the box:**

- 01) Your name
- 02) Your address
- 03) Your phone number
- 04) A brief description of the symptoms

## Claims

The client has the obligation to check the delivered goods immediately upon delivery for any shortcomings and/or visible defects, or perform this check after our announcement that the goods are at their disposal. Damage incurred in shipping is the responsibility of the shipper; therefore the damage must be reported to the carrier upon receipt of merchandise.

It is the customer's responsibility to notify and submit claims with the shipper in the event that a fixture is damaged due to shipping. Transportation damage has to be reported to us within one day after receipt of the delivery.

Any return shipment has to be made post-paid at all times. Return shipments must be accompanied with a letter defining the reason for return shipment. Non-prepaid return shipments will be refused, unless otherwise agreed in writing.

Complaints against us must be made known in writing or by fax within 10 working days after receipt of the invoice. After this period complaints will not be handled anymore.

Complaints will only then be considered if the client has so far complied with all parts of the agreement, regardless of the agreement of which the obligation is resulting.



## Description of the device

---

### Features

The Mistique is a powerful hazer machine. This hazer produces an extremely fine haze due to the combination of low pressurised CO<sub>2</sub> and a high quality oil-based Mistique dedicated Hazer-liquid.

- Input Voltage: 100-240VAC, 50/60Hz
- Power consumption: 1250W max
- Heating time: under 8 min.
- Maximum Output: 5000 cu.ft/min
- Output Direction: Up, down, forward
- Output Regulation: 5-40psi
- Tank capacity: 2,5 L
- Liquid Type: MHL-2 only
- Liquid Consumption: 120ml/hour (@40psi)
- Gas Type: CO<sub>2</sub> or N<sub>2</sub>
- Gas Consumption: 0,36Kg/hour (@ 40psi)
- Gas Pressure: 50 to 60 psi / 3,4 to 4.1 bar max.
- On Board: Battery powered LCD TFT touchscreen
- Control Mode: Manual mode, 2x Timer mode, DMX control, Wireless DMX control.
- DMX Mode: 1, 3, 5 channels
- Colour: Black
- Housing: Metal & Flame-retardant plastic
- Data Connection: Neutrik XLR 5p & 3p in- & output
- Gas Connection: Male Q-lock
- Power connection: Neutrik Powercon True1 in- & output
- Working environment: +5°C ~ 45°C
- Ingress Protection: IP-20
- Fan Speed: 20-100%
- Very even and thin haze ensures no visible cloudy effect on stage
- Extreme silent operation due to CO<sub>2</sub> supply
- Output and fan speed remote controllable by DMX and W-DMX
- Fast and easy setup with Q-lock CO<sub>2</sub> hose system
- Automatic fuse: 8A/250V
- Dimensions: 503 x 334 x 310 mm (LxWxH)
- Weight: 17 kg

**Note:** The Mistique needs a CO<sub>2</sub> connection with a gas tank to create haze.

### Optional accessories:

[60569](#) – MHL-2 Hazer Fluid

[61017](#) – CO<sub>2</sub> 3/8 Q-Lock Hose

[61019](#) – CO<sub>2</sub> Q-Lock Regulator

[61021](#) – CO<sub>2</sub> 90° 3/8 Q-Lock connector

Frontside

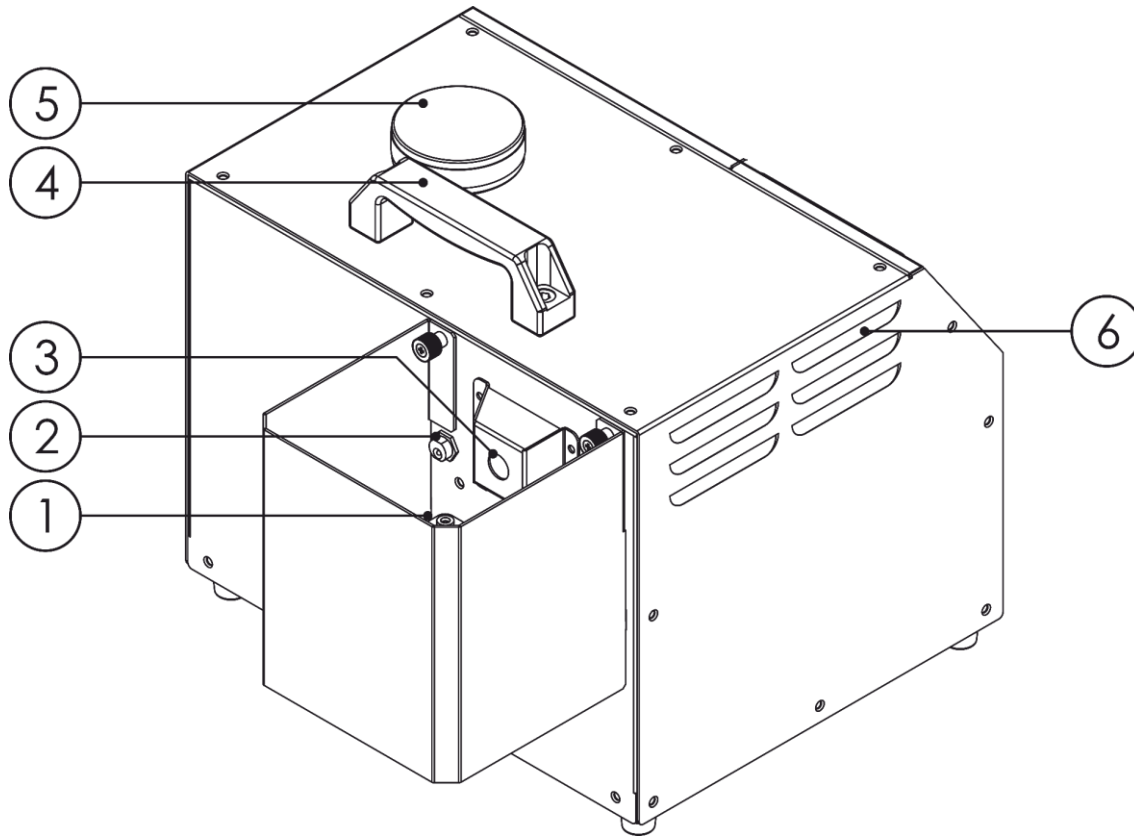

Fig. 01

- 01) Fan
- 02) Plug with adapter for power to the fan
- 03) Output nozzle
- 04) Carry handle
- 05) MHL fluid tank (2,5 L)
- 06) Ventilation

Backside

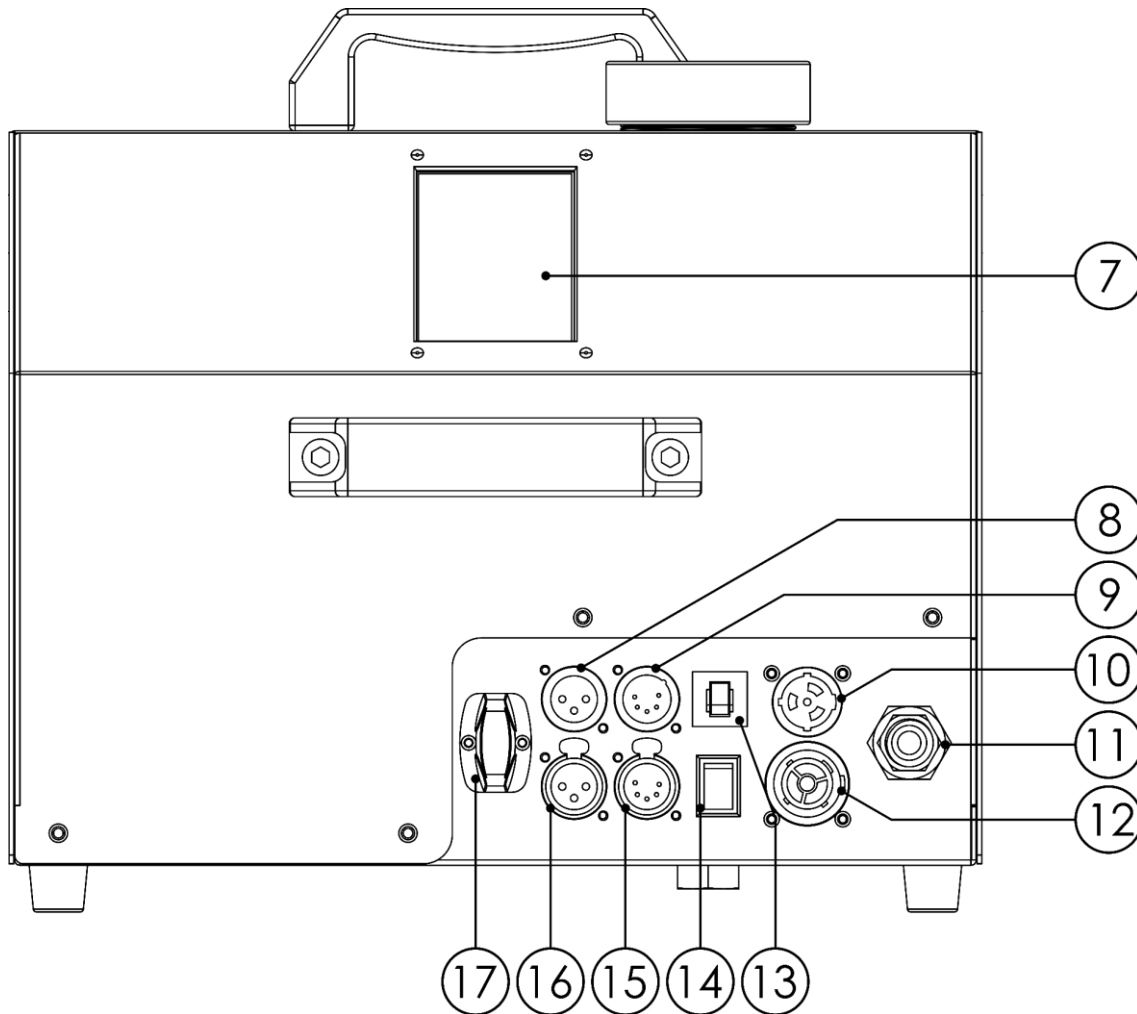

Fig. 02

- 07) LCD Touch Display
- 08) 3-pin DMX signal connector IN
- 09) 5-pin DMX signal connector IN
- 10) 100–240 V True1 pro power connector IN
- 11) Input for Gas; Only use CO<sub>2</sub> or N<sub>2</sub>, gas pressure min 50 psi, max 60 psi. / 3,4 to 4.1 bar max, Quick-lock coupling
- 12) 100–240 V True1 pro power connector OUT
- 13) Automatic Fuse 8A/250V
- 14) Menu ON/OFF  
Press and hold for 3 seconds to activate the menu. You can check/ change your settings without connecting the Mistique to the mains power.
- Note:** You can not faze without connecting the Mistique to the mains power.
- 15) 5-pin DMX signal connector OUT
- 16) 3-pin DMX signal connector OUT
- 17) Wireless DMX receiver antenna

## Installation

Remove all packing materials from the Mistique. Check if all foam and plastic padding is removed, especially in the haze output area.

Use the Mistique only with MHL-2 hazer fluid ([60569](#)). Any other types of liquid can damage the unit. The unit can also be operated at floor level or sitting on any regular surface as well.

Do not point the output in a direction that will aim directly at a person.

Whatever installation method you choose, the unit must always be placed in horizontal position.

The maximum inclination angle of the device should not exceed 30°.

**Always disconnect from electric mains power supply before cleaning or servicing.**

**Damages caused by non-observance are not subject to warranty.**



### CAUTION!

**Read all the warnings and safety instructions before installation!  
Knowledge of safety instructions is CRUCIAL for a safe use!**



**CAUTION! USE ONLY APPROVED CO2 BOTTLES (liquid carbon dioxide with dip pipe)!**  
**Consult a gas supplier about the installation, usage and  
guidelines for a safe use of the CO2 bottles!**



### CAUTION!

**Follow all warnings and safety instructions during installation/operation!**  
**Non-observance could lead to severe injuries or even death !!!**



Always follow the instructions from this manual, from your CO<sub>2</sub> supplier and from local authorities.

### Precautions for operation



Using a damaged or an improperly installed machine can lead to death, serious injury or property damage. Always inspect the machine thoroughly before operation.



Missing or obscured safety symbols on the machine can cause unawareness, which in turn can lead to death, serious injury or property damage. Make sure all safety symbols are correctly in place and visible. See front side of the device.

## Set Up and Operation

Before plugging the unit in, always make sure that the power supply matches the product specification voltage. Do not attempt to operate a 120V specification product on 230V power, or vice versa.

**Note: Always monitor haze tank level liquid indicator when creating a fine haze!**

**Note: Be careful not to exceed the maximum fluid level. DO NOT OVERFILL!**

**Note: You can only fill 80% of the tank. So not more than 2L in the tank, due the compression.**

**Note: Running a haze machine with no hazer liquid can permanently damage the unit!**

**Note: Never shut down the Mistique while making haze.**

**Note: The Mistique needs a CO2 connection with a gas tank to create haze.**

**Note: Installation and operation of the Mistique requires professional and trained personnel.**

### Remove cover and fan to change output direction

You can change the output direction by removing the metal cover or by turning the fan upside-down.

 Change front only when device is not running and cold.

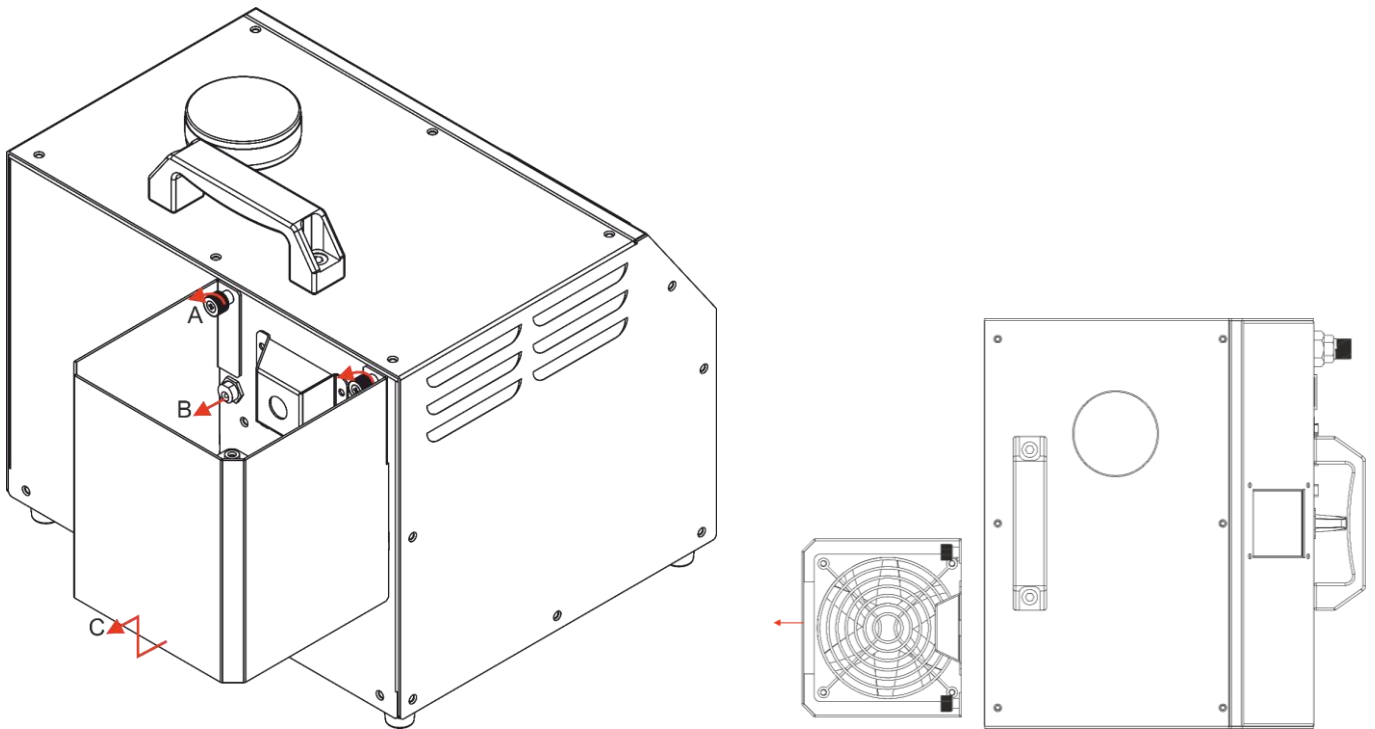

- 01) First unscrew the 2 screws (A).
- 02) Then remove the DC plug from the device (B).
- 03) Remove the cover by pulling it up and then away from the machine ©.

Start up

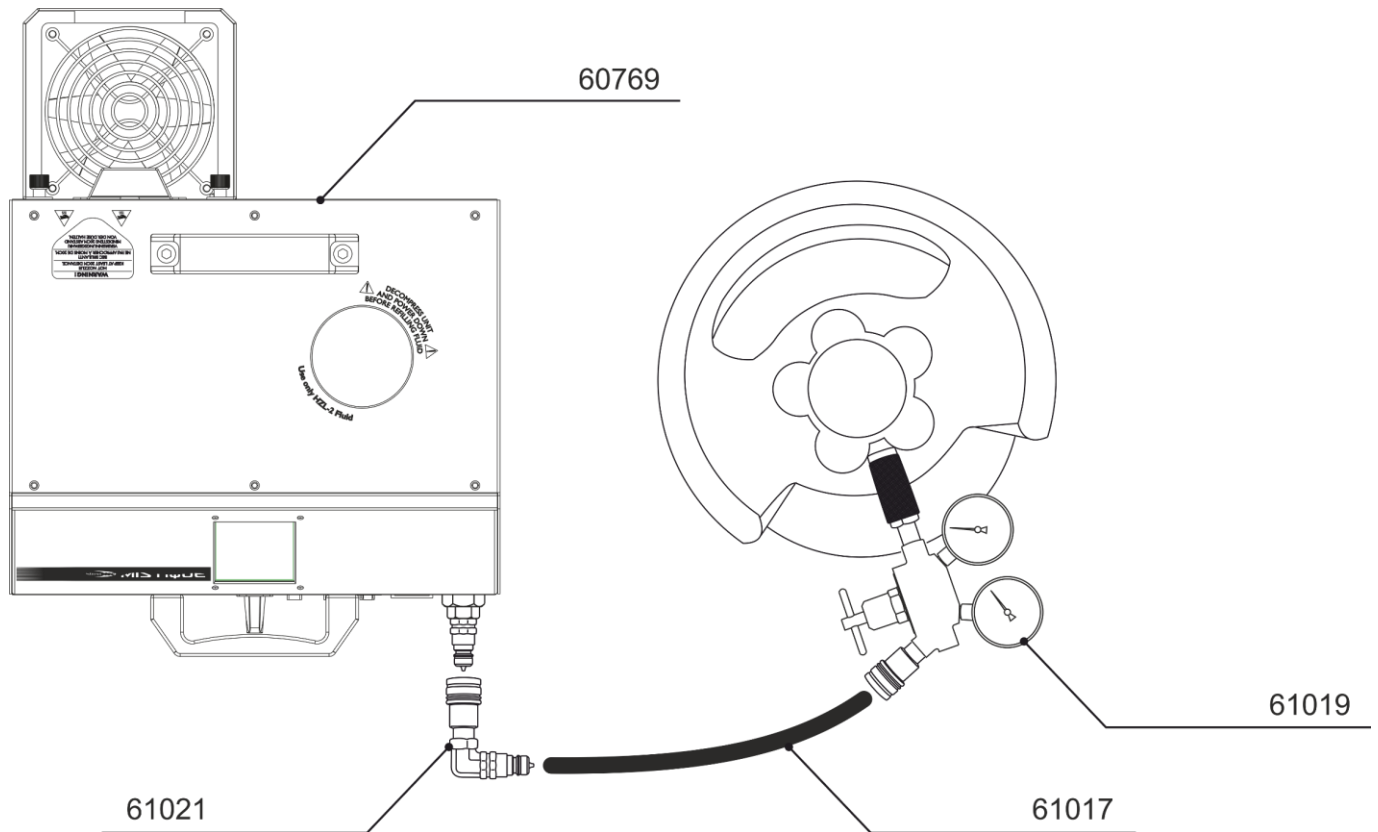

- 01) Put the Mistique Hazer on a flat surface and keep a minimum of 50 cm distance from any objects. Make sure there is enough room to install all cables and CO<sub>2</sub> hoses.
- 02) Slowly fill in the liquid tank with the designated MHL-2 hazer fluid.  
**Note:** It is strongly recommended to limit each refill to a maximum of 1 liter of MHL-2 hazer fluid.  
**Note:** Be careful not to exceed the maximum fluid level. DO NOT OVERFILL!  
**Note:** You can only fill 80% of the tank. So not more than 2L in the tank, due the compression.
- 03) Connect the Machine "air-in" to the pressure regulator with gas tank and open the adjuster value between 50 - 60 PSI (3.5-4.1 bar or 350 – 410 kPa) position.
- 04) Plug the power cord into a grounded electrical outlet. Set the power switch to ON.
- 05) You have to start the heater warm up via the manual function or by DMX.

06) The device will now start to warm up and the display shows .

Warm-up is complete when the upper left corner of LCD control panel shows . The device is now ready for operation.

07) Please go to the manual Menu on the control panel and press Start to start hazing.



08) When you have finished hazing, Press  to activate the Power Off menu.

09) The next window will show:



- 10) Close the CO<sub>2</sub> now.
- 11) The counter will count down from 10 to zero.
- 12) Let the Mistique decompress and please wait until the pressure is down.
- 13) Now you can decouple the CO<sub>2</sub> hose and the power cable.

## Control Modes

There are 2 modes:

- Stand-alone
- DMX512 (1CH, 3CH, 5CH)

### One Mistique (Stand-alone)

- 01) Leave at least 1 meter on all sides for air circulation.
- 02) Plug the end of the electric mains power cord into a proper electric power supply socket.
- 03) When the Mistique is not connected by a DMX cable, it functions as a stand-alone device.
- 04) Please see page 31 for more information about the stand alone mode.

### Multiple Mistiques (DMX Control)

- 01) Fasten the effect light onto firm trussing. Leave at least 1 meter on all sides for air circulation.
- 02) Plug the end of the electric mains power cord into a proper electric power supply socket.
- 03) Use a 3-pin/5-pin XLR cable to connect the Mistiques and other devices.



Pin 1: GND (screen)  
 Pin 2: Signal (-)  
 Pin 3: Signal (+)  
 Pin 4: N/C  
 Pin 5: N/C

Pin 1: GND (screen)  
 Pin 2: Signal (-)  
 Pin 3: Signal (+)



Pin 1: GND (screen)  
 Pin 2: Signal (-)  
 Pin 3: Signal (+)

Pin 1: GND (screen)  
 Pin 2: Signal (-)  
 Pin 3: Signal (+)  
 Pin 4: N/C  
 Pin 5: N/C

- 04) Link the units as shown in fig. 04. Connect a DMX signal cable from the first unit's DMX "out" socket to the second unit's "in" socket. Repeat this process to link the second, third, and fourth units.
- 05) Supply electric power: Plug electric mains power cords into each unit's PowerCON socket, then plug the other end of the mains power cord into proper electric power supply sockets, starting with the first unit. Do not supply power before the whole system is set up and connected properly.



Multiple Mistiques DMX Set Up

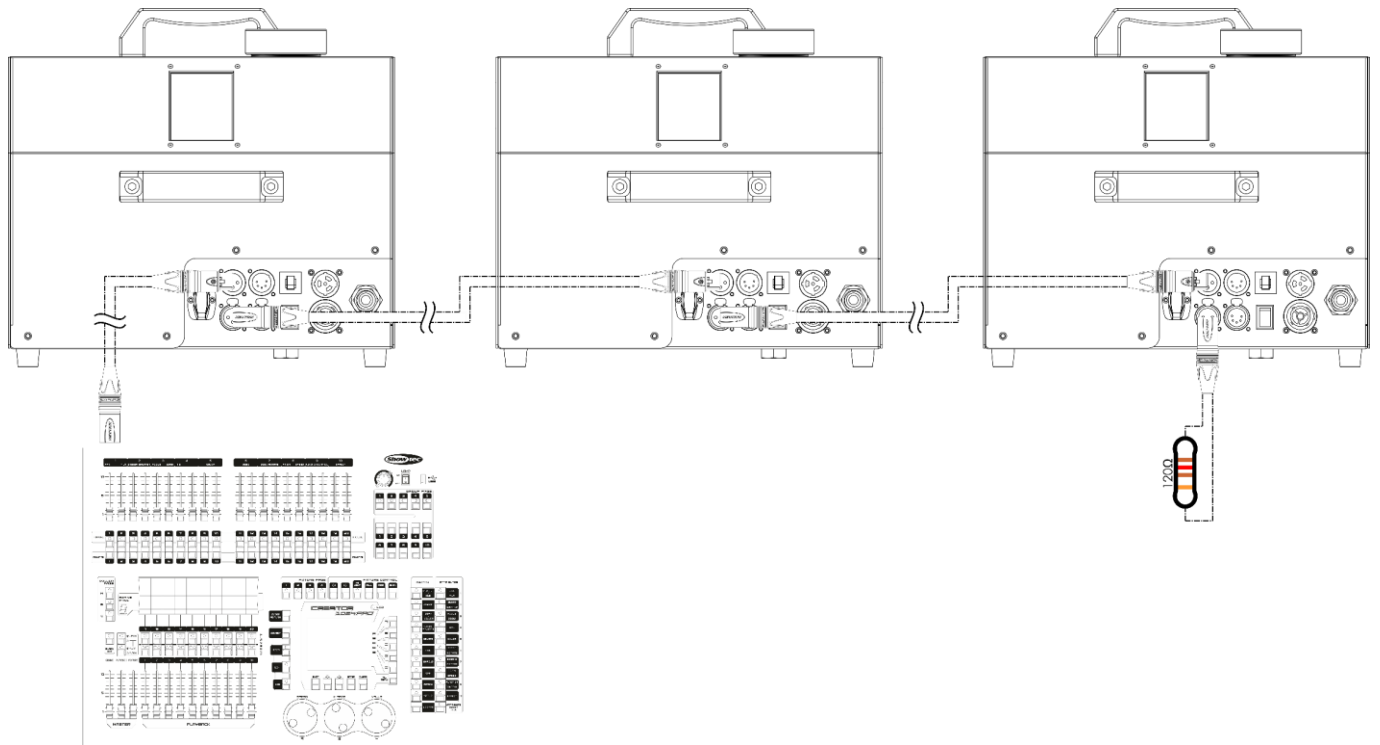



Fig. 04

Note : Link all cables before connecting electric power

## Fixture Linking

You will need a serial data link to run light shows of one or more fixtures using a DMX-512 controller or to run synchronized shows on two or more fixtures set to a master/slave operating mode. The combined number of channels required by all the fixtures on a serial data link determines the number of fixtures the data link can support.

**Important:** Fixtures on a serial data link must be daisy chained in one single line. To comply with the EIA-485 standard no more than 30 devices should be connected on one data link. Connecting more than 30 fixtures on one serial data link without the use of a DMX optically isolated splitter may result in deterioration of the digital DMX signal.

 Maximum recommended DMX data link distance: 100 meters  
Maximum recommended number of fixtures on a DMX data link: 30 fixtures  
Maximum recommended number of fixtures on a power link @120V: 3 fixtures  
Maximum recommended number of fixtures on a power link @230V: 3 fixtures

## Data Cabling

To link fixtures together you must obtain data cables. You can purchase DAP Audio certified DMX cables directly from a dealer/distributor or construct your own cable. If you choose to create your own cable please use data-grade cables that can carry a high quality signal and are less prone to electromagnetic interference.

### DAP Audio Certified DMX Data Cables

- DAP Audio Basic microphone cable for allround use. bal. XLR/M 3-pin > XLR/F 3-pin. **Ordercode** FL01150 (1,5 m), FL013 (3 m), FL016 (6 m), FL0110 (10 m), FL0115 (15 m), FL0120 (20 m).
- DAP Audio X-type data cable XLR/M 3-pin > XLR/F 3-pin. **Ordercode** FLX0175 (0,75 m), FLX01150 (1,5 m), FLX013 (3 m), FLX016 (6 m), FLX0110 (10 m).
- DAP Audio cable for the demanding user with exceptional audio-qualities and connector made by Neutrik®. **Ordercode** FL71150 (1,5 m), FL713 (3 m), FL716 (6 m), FL7110 (10 m).
- DAP Audio cable for the demanding user with exceptional audio-qualities and connector made by Neutrik®. **Ordercode** FL7275 (0,75 m), FL72150 (1,5 m), FL723 (3 m), FL726 (6 m), FL7210 (10 m).
- DAP Audio 110 Ohm cable with digital signal transmission. **Ordercode** FL0975 (0,75 m), FL09150 (1,5 m), FL093 (3 m), FL096 (6 m), FL0910 (10 m), FL0915 (15 m), FL0920 (20 m).

The Mistique can be operated with a controller in **control mode** or without the controller in **stand-alone mode**.

## Control Panel

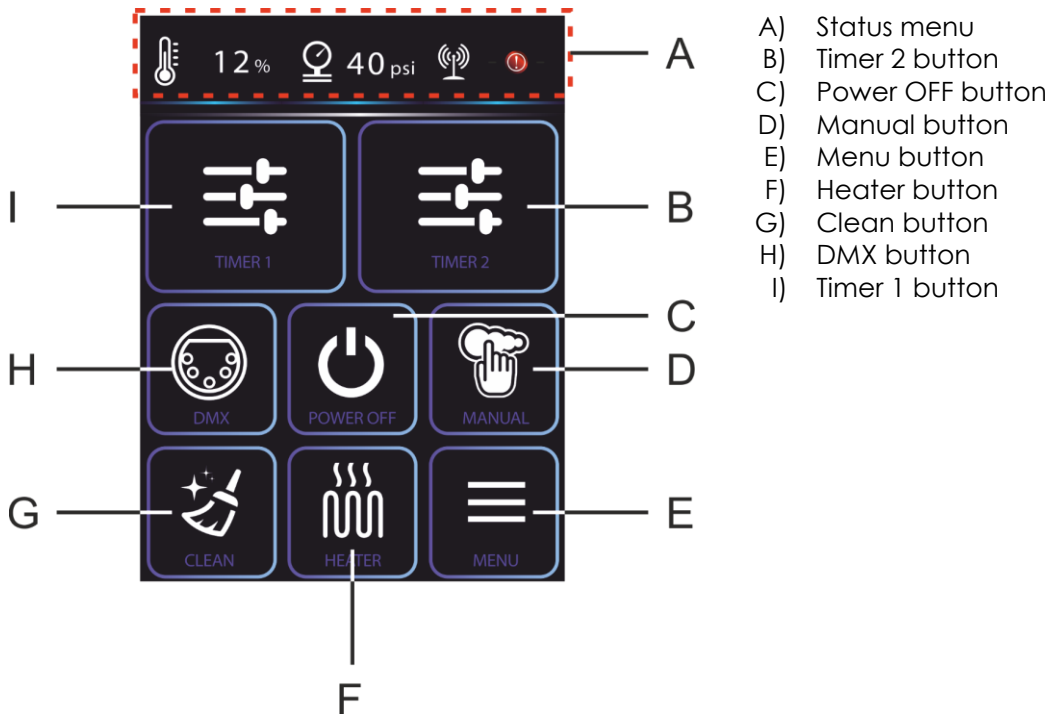

Fig. 05

## Control Mode

The fixtures are individually addressed on a data-link and connected to the controller. The fixtures respond to the DMX signal from the controller. (When you select the DMX address and save it, the controller will display the saved DMX address the next time.)

## DMX Addressing

The control panel on the front side of the base allows you to assign the DMX fixture address, which is the first channel from which the Mistique will respond to the controller.

Please note when you use the controller, the unit has a maximum of **5** channels.

When using multiple Mistiques, make sure you set the DMX addresses right.

Therefore, the DMX address of the first Mistique should be **1(001)**; the DMX address of the second Mistique should be **1+5=6 (006)**; the DMX address of the third Mistique should be **6+5=11 (011)**, etc.

Please, be sure that you do not have any overlapping channels in order to control each Mistique correctly.

If two or more Mistiques are addressed similarly, they will work similarly. For address settings, please refer to the instructions under "Addressing".

## Controlling:

After having addressed all Mistique fixtures, you may now start operating these via your lighting controller.

**Note:** After switching on, the Mistique will automatically detect whether DMX 512 data is received or not. If there is no data received at the DMX-input, the a red dot will be shown on the control panel.

The problem may be:

- The XLR cable from the controller is not connected with the input of the Mistique.
- The controller is switched off or defective, the cable or connector is defective, or the signal wires are swapped in the input connector.

**Note:** It's necessary to insert a XLR termination plug (with 120 Ohm) in the last fixture in order to ensure proper transmission on the DMX data link.



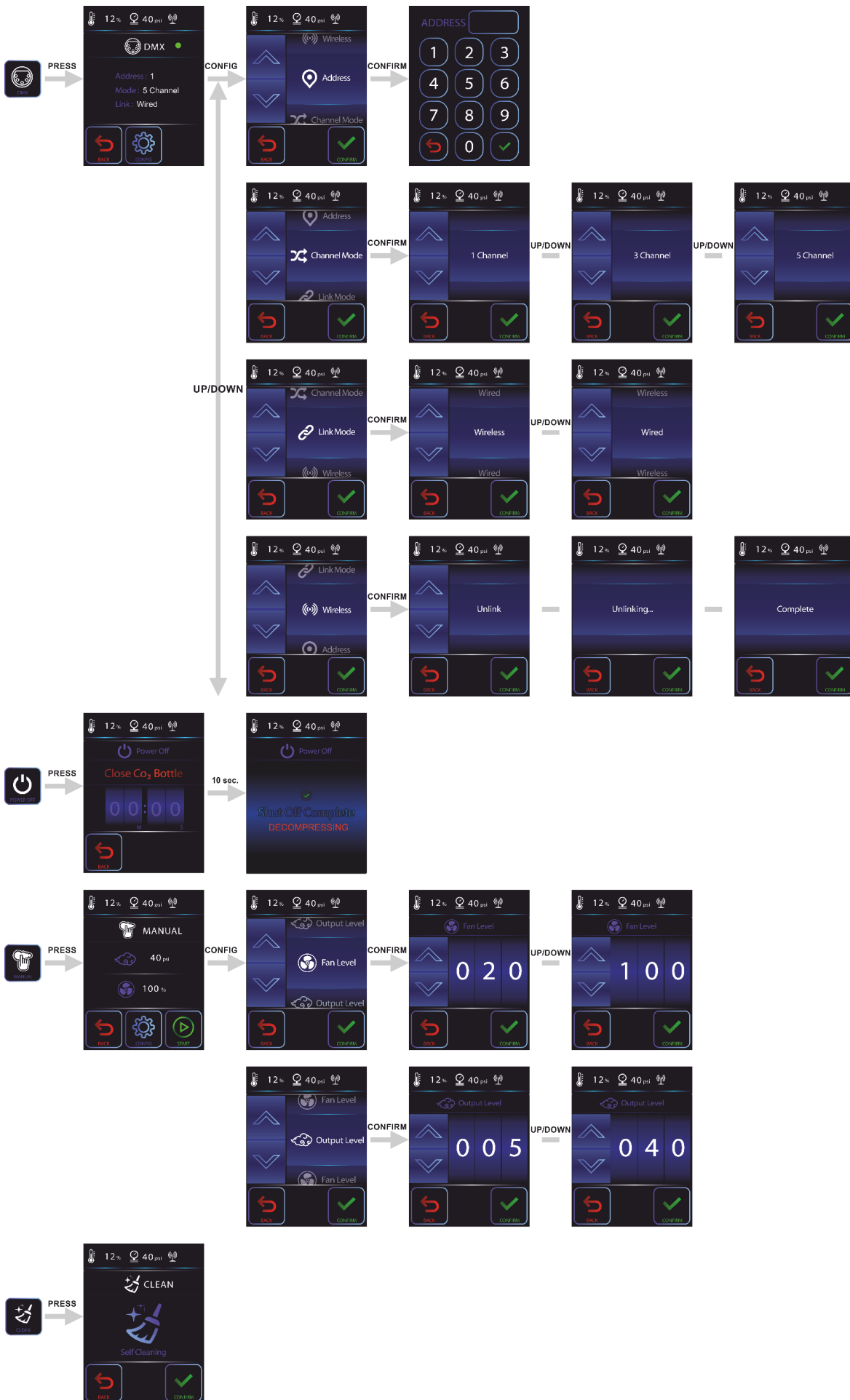

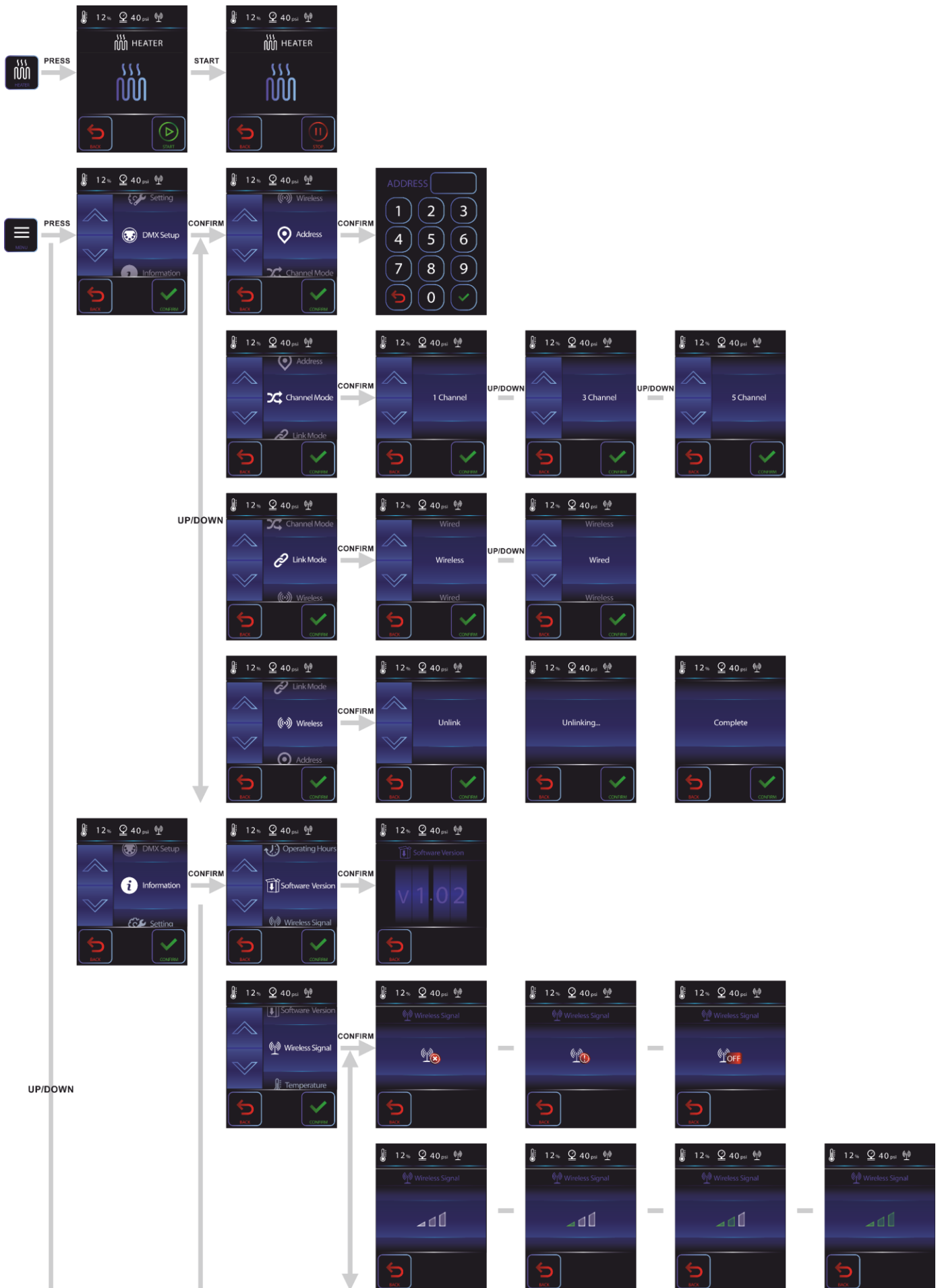

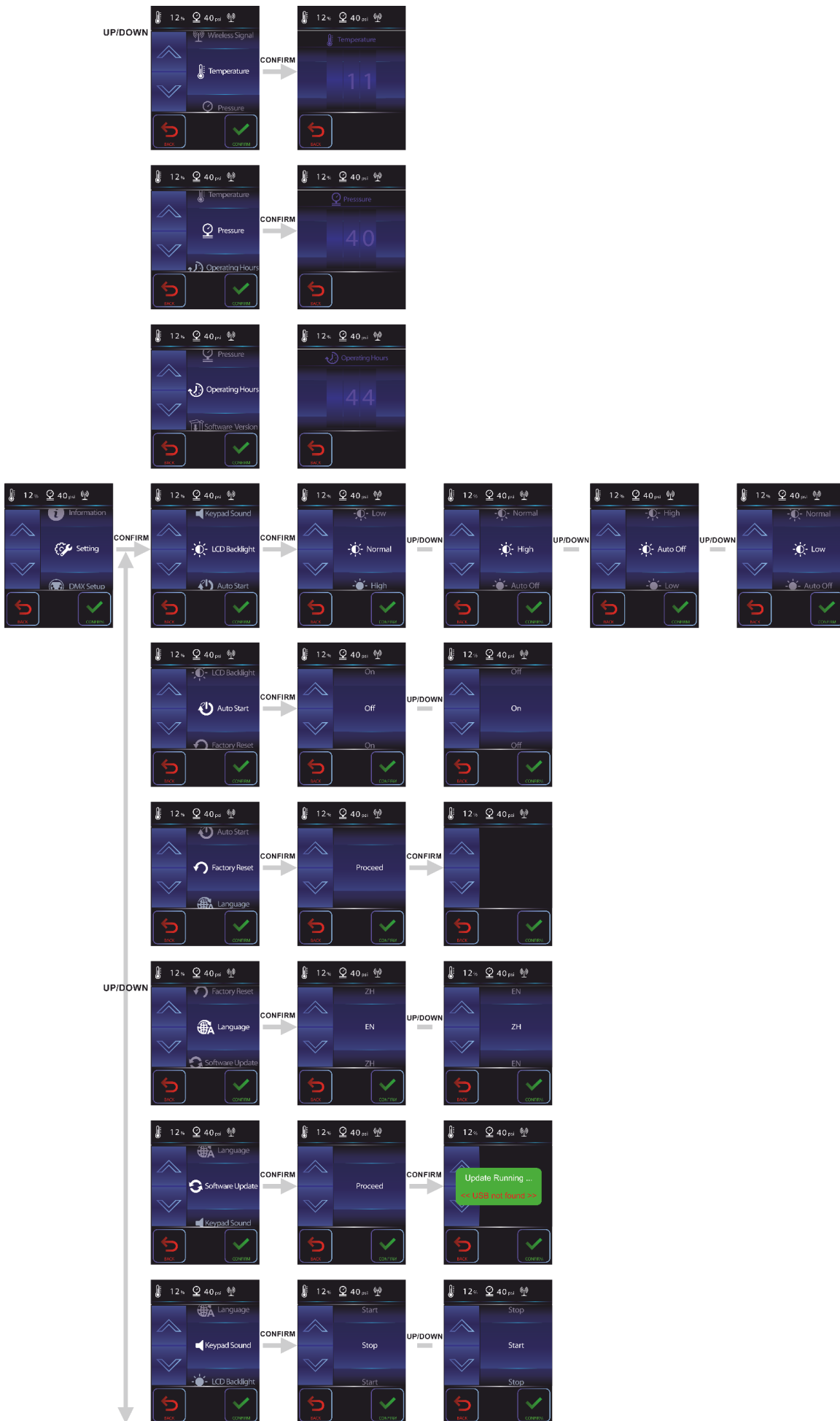

## Main Menu Options



Timer 1



Timer 2



DMX Mode



Power OFF



Manual Mode



Clean Mode



Heater



Menu



### Status Menu

With this menu you see the status of your Mistique.

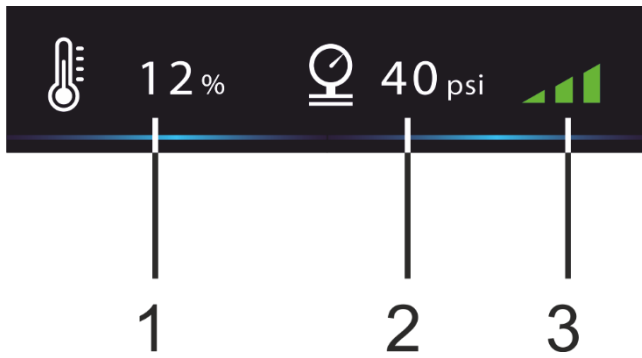

- 1) Heater temperature percentage
- 2) Output pressure value
- 3) WDMX signal strength

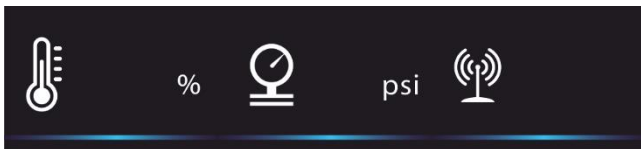

Ready

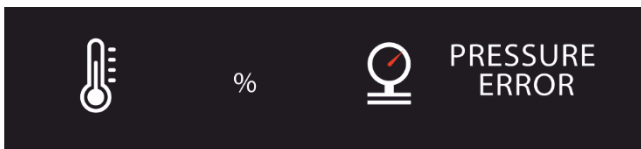

Heating coil is on + detected pressure error



Temperature error + detected pressure error

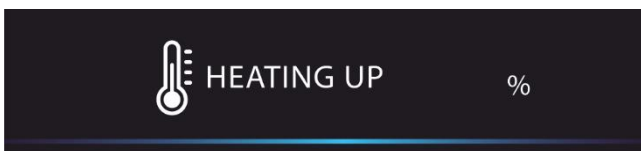

Continuous heating

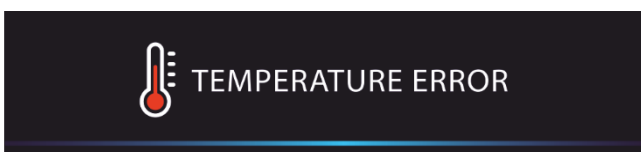

Heating coil temperature error



Pressure error

## 1. Timer 1

With this menu you can set the Timer settings.



- 01) Press **TIMER 1** to open the menu.
- 02) The next window will show the current settings:



- 03) Press **START** to start hazing with the current settings or press **CONFIG** to adjust them.
- 04) If you have chosen **CONFIG**, press **UP/DOWN** to choose one of the 4 settings:
  - Interval
  - Duration
  - Output Level
  - Fan Level

### 1.1 Interval

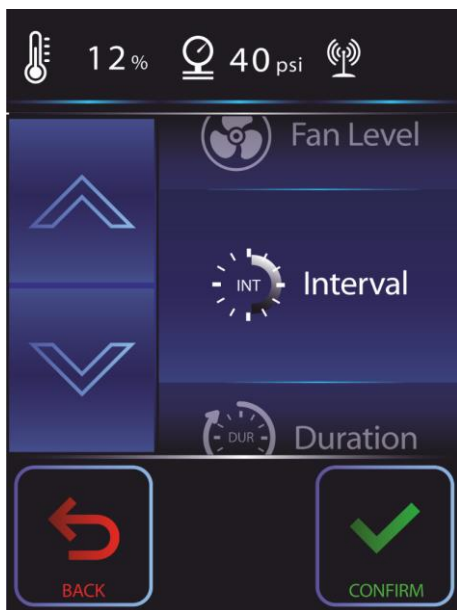

- 01) Press **CONFIRM** to enter the interval menu.
- 02) Press **UP/DOWN** to adjust the timer interval. The adjustment range is between 1–200 min.
- 03) Press **CONFIRM** to confirm your setting.

## 1.2 Duration

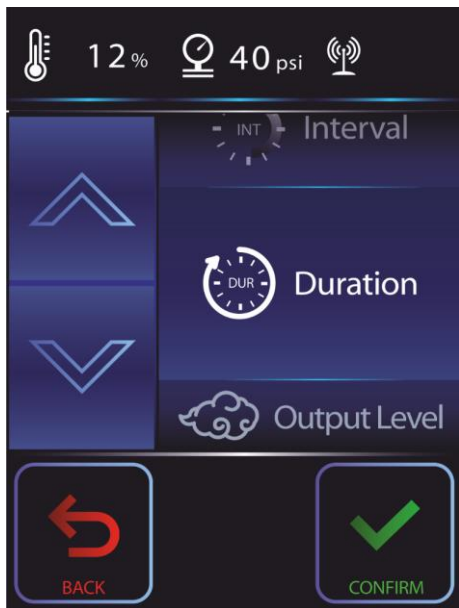

- 01) Press **CONFIRM** to enter the duration menu.
- 02) Press **UP/DOWN** to adjust the timer duration. The adjustment range is between 1–200 min.
- 03) Press **CONFIRM** to confirm your setting.

## 1.3 Output Level

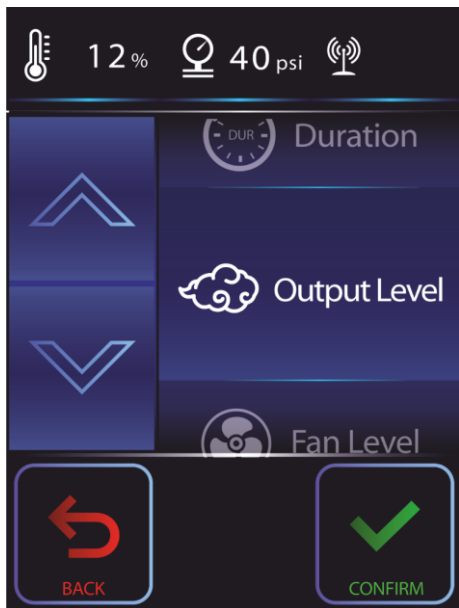

- 01) Press **CONFIRM** to enter the output level menu.
- 02) Press **UP/DOWN** to adjust the output level. The adjustment range is between 5–40 psi.
- 03) Press **CONFIRM** to confirm your setting.

## 1.4 Fan Level

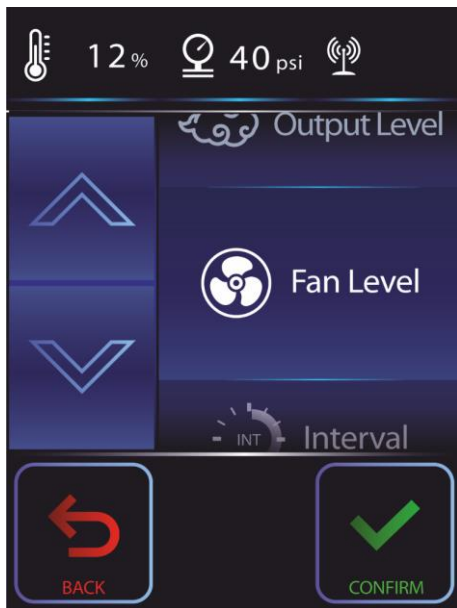

- 01) Press **CONFIRM** to enter the fan level menu.
- 02) Press **UP/DOWN** to adjust the fan level. The adjustment range is between 20-100%.
- 03) Press **CONFIRM** to confirm your setting.

## 2. Timer 2

With this menu you can set the Timer settings for Timer 2.

For setup options please see Timer 1, page 21–23.

Timer 1 + Timer 2 can have different settings, depending on the user preferences.

### 3. DMX Channel

With this menu you can set the desired DMX operating mode.



- 01) Press **DMX** to open the menu.
- 02) The next window will show the current settings:

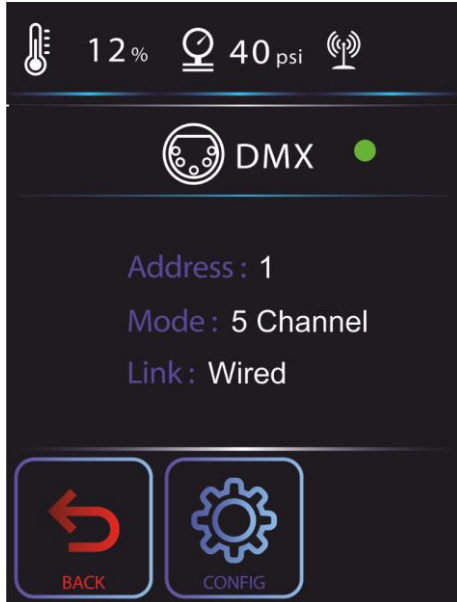

- 03) Press **CONFIG** to adjust the current settings.
- 04) If you have chosen **CONFIG**, press **UP/DOWN** to choose one of the 4 settings:
  - Address
  - Channel Mode
  - Link Mode
  - Wireless (Only visible when you set the link mode to wireless)

#### 3.1 Address

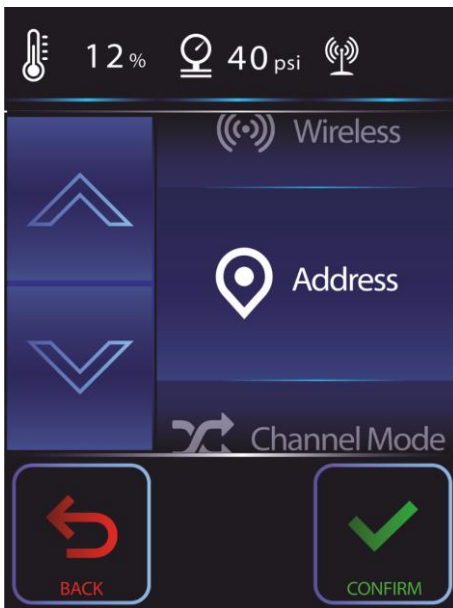

01) Press **CONFIRM** to enter the address menu, the display will show:

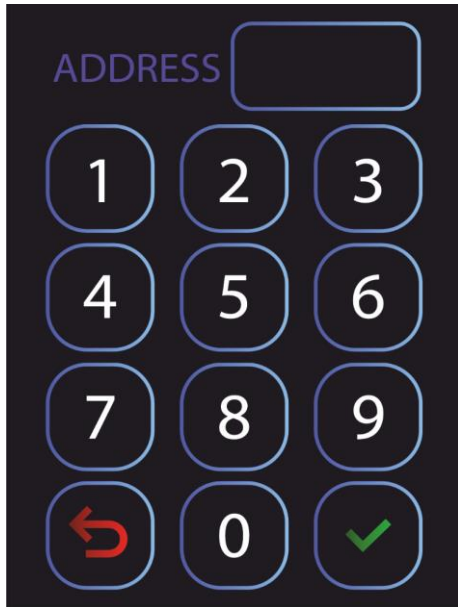

02) Press the buttons to set the desired DMX address.

- If you choose the 1CH configuration, the adjustment range is between 1-511.
- If you choose the 3 CH configuration, the adjustment range is between 1-509.
- If you choose the 5CH configuration, the adjustment range is between 1-507.



03) Press  to confirm your setting.

### 3.2 Channel Mode

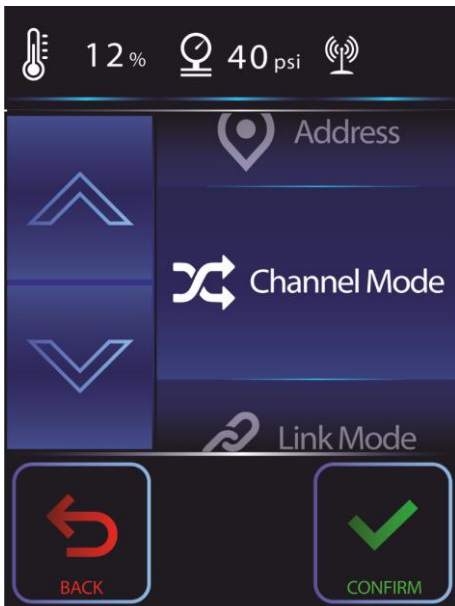

01) Press **CONFIRM** to enter the Channel Mode menu.

01) Press **UP/DOWN** to select one of the 3 DMX channel modes:

- 1-channel mode
- 3-channel mode
- 5-channel mode

02) Press **CONFIRM** to confirm your setting.

### 3.3 Link Mode

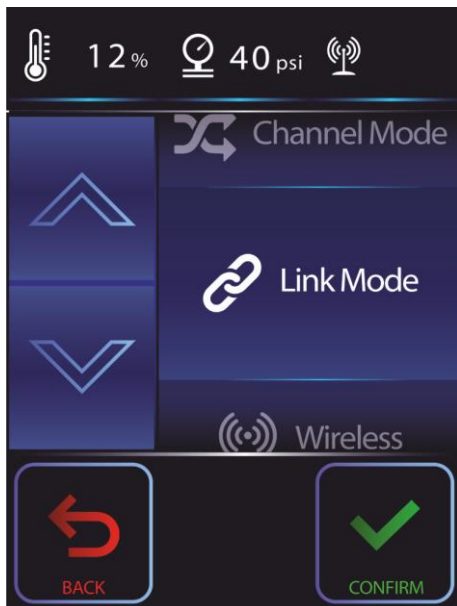

- 01) Press **CONFIRM** to enter the Link Mode menu.
- 02) Press **UP/DOWN** to select one of the 2 modes:
  - Wireless
  - Wired
- 03) Press **CONFIRM** to confirm your setting.

### 3.4 Wireless Mode

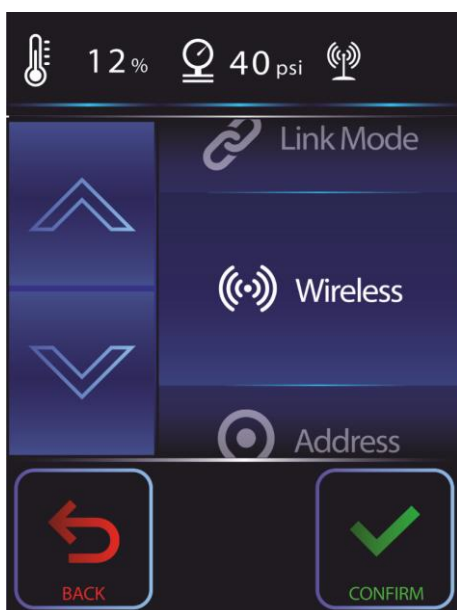

- 01) Press **CONFIRM** to enter the wireless menu.
- 02) Press **UP/DOWN** to select the wireless unlink
- 03) Press **CONFIRM** to confirm your setting.
- 04) The display will show: **Unlinking** and the **Complete**. The device has now been unlinked.

## 4. Power Off

With this menu you can activate the power off procedure.



- 01) Press  to activate the menu.
- 02) The next window will show:

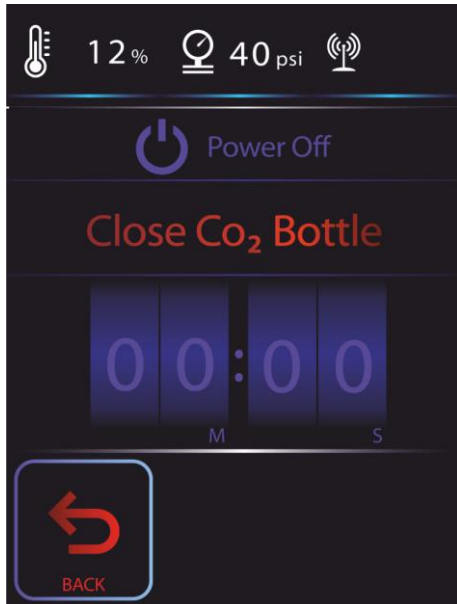

- 03) Close the CO<sub>2</sub> now.
- 04) The counter will count down from 10 to zero.
- 05) Let the Mistique decompress and please wait until the pressure is down.
- 06) Now you can decouple the CO<sub>2</sub> hose and the power cable.

## 5. Manual

With this menu you can manual control your Mistique.



- 01) Press  to open the menu.
- 02) The next window will show the current settings:

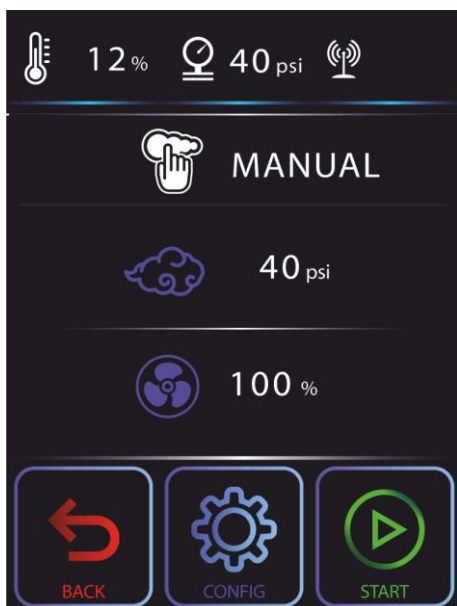



## 5.1 Output Level

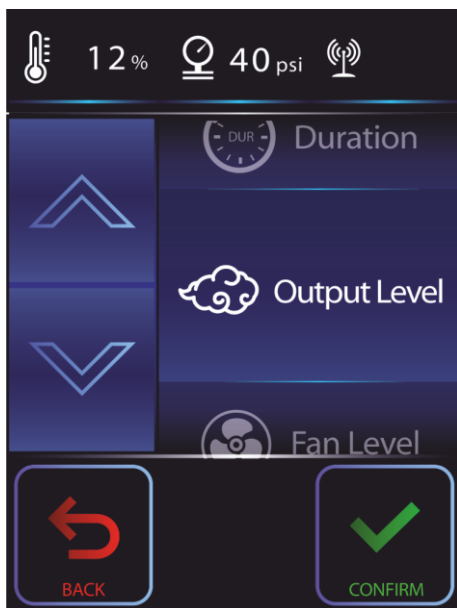

- 01) Press **CONFIRM** to enter the output level menu.
- 02) Press **UP/DOWN** to adjust the output level. The adjustment range is between 5–40 psi.
- 03) Press **CONFIRM** to confirm your setting.

## 5.2 Fan Level

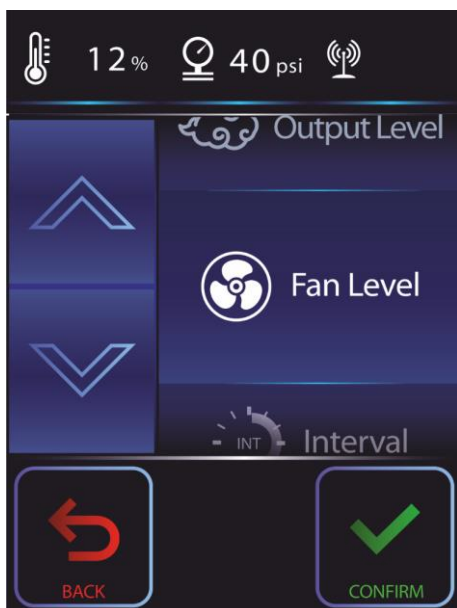

- 01) Press **CONFIRM** to enter the fan level menu.
- 02) Press **UP/DOWN** to adjust the fan level. The adjustment range is between 20-100%.
- 03) Press **CONFIRM** to confirm your setting.

## 6. Clean

With this menu you can start the manual cleaning procedure.



- 01) Press **CLEAN** to open the menu.
- 02) The next window will show:

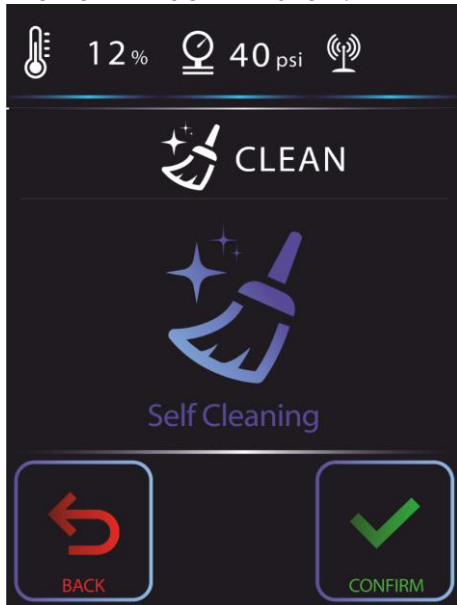

- 03) Press **CONFIRM** to start the cleaning process.
- 04) Once the countdown reaches 0.00, cleaning is finished and the Mistique machine is ready for use.

## 7. Heater

With this menu you can start the heater.



- 01) Press **HEATER** to open the menu.
- 02) The next window will show:

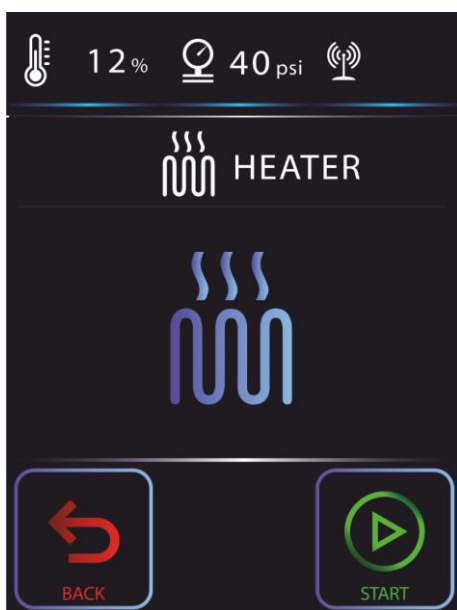

- 03) The heater is OFF
- 04) Press **START** to start the heating process.

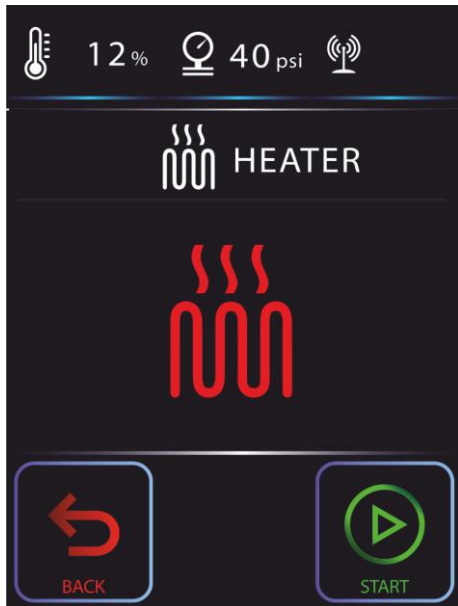

Heater is ON, but Mistique not ready to haze.

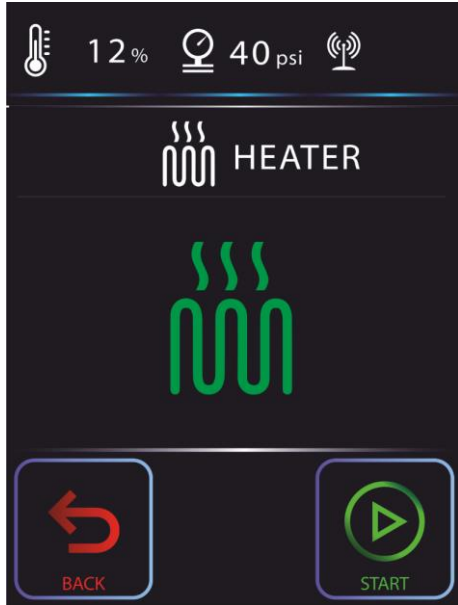

Heater is ON and Mistique is ready to haze.

05) If you press **START** button again the heating process will stop and the display will show:



## 8. Menu

With this menu you can open the entire menu and view all settings.



- 01) Press the **MENU** to open the menu.
- 02) Press the **UP/DOWN** buttons to choose one of the 3 settings:
  - DMX Setup
  - Information
  - Setting

### 8.1 DMX Setup



- 01) Press **CONFIRM** to enter the DMX Setup menu.
- 02) Press the **UP/DOWN** buttons to choose one of the 4 settings:
  - Address
  - Channel Mode
  - Link Mode
  - Wireless

#### 8.1.1 Address

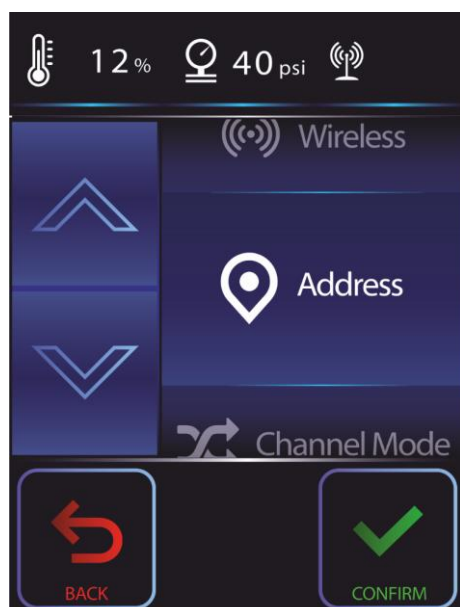

01) Press **CONFIRM** to enter the address menu, the display will show:

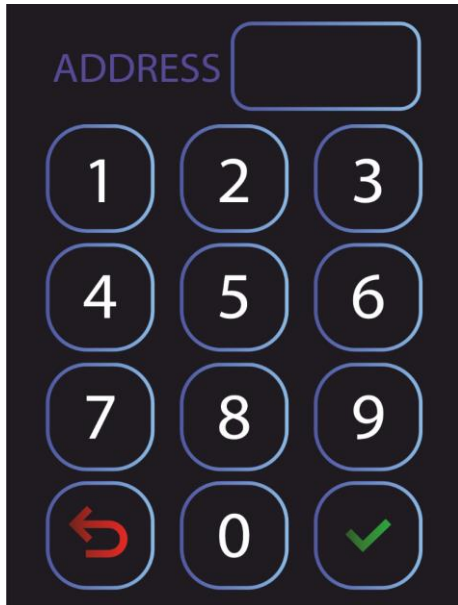

02) Press the buttons to set the desired DMX address.

- If you choose the 1CH configuration, the adjustment range is between 1-511.
- If you choose the 3 CH configuration, the adjustment range is between 1-509.
- If you choose the 5CH configuration, the adjustment range is between 1-507.

03) Press  to confirm your setting.

### 8.1.2 Channel Mode

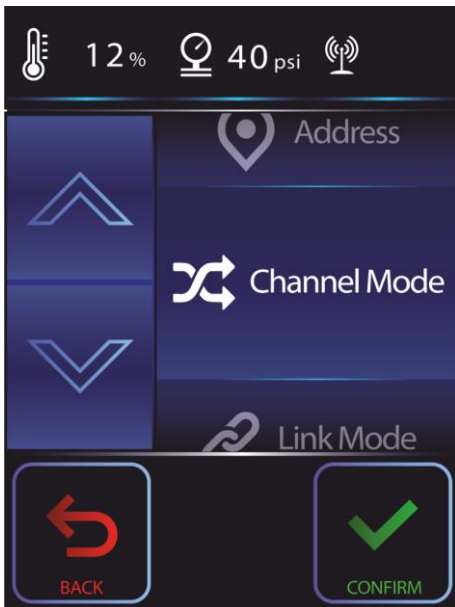

01) Press **CONFIRM** to enter the Channel Mode menu.

02) Press **UP/DOWN** to select one of the 3 DMX channel modes:

- 1-channel mode
- 3-channel mode
- 5-channel mode

03) Press **CONFIRM** to confirm your setting.

### 8.1.3 Link Mode

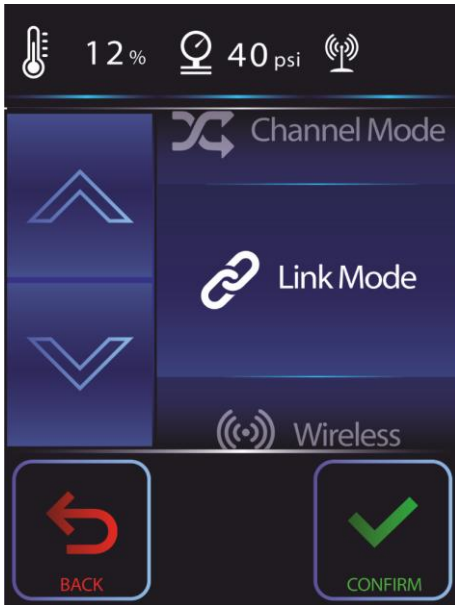

- 01) Press **CONFIRM** to enter the Link Mode menu.
- 02) Press **UP/DOWN** to select one of the 2 modes:
  - Wireless
  - Wired
- 03) Press **CONFIRM** to confirm your setting.

### 8.1.4 Wireless Mode

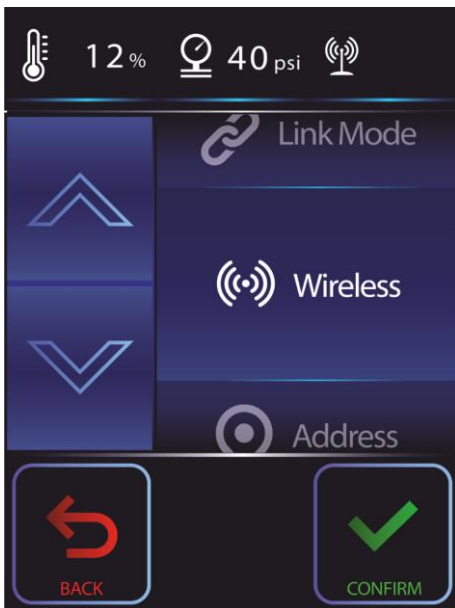

- 01) Press **CONFIRM** to enter the wireless menu.
- 02) Press **UP/DOWN** to select the wireless unlink
- 03) Press **CONFIRM** to confirm your setting.
- 04) The display will show: **Unlinking** and the **Complete**. The device has now been unlinked.

## 8.2 Information

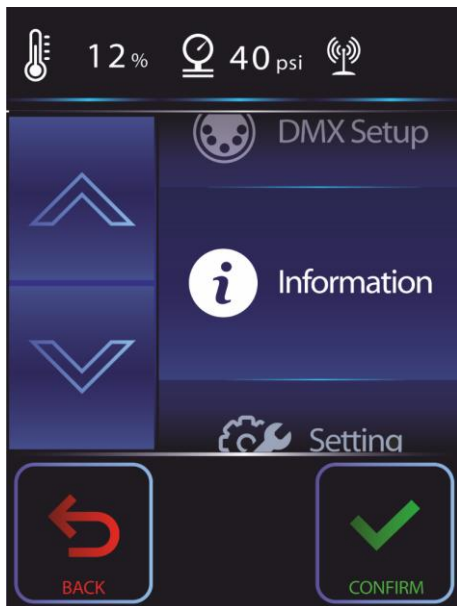

- 01) Press **CONFIRM** to enter the Information menu.
- 02) Press the **UP/DOWN** buttons to choose one of the 5 settings:
  - Software Version
  - Wireless Signal
  - Temperature
  - Pressure
  - Operating Hours

## 8.2.1 Software Version



- 01) Press **CONFIRM** to enter the Software Version menu.
- 02) The next window will show the current software version:

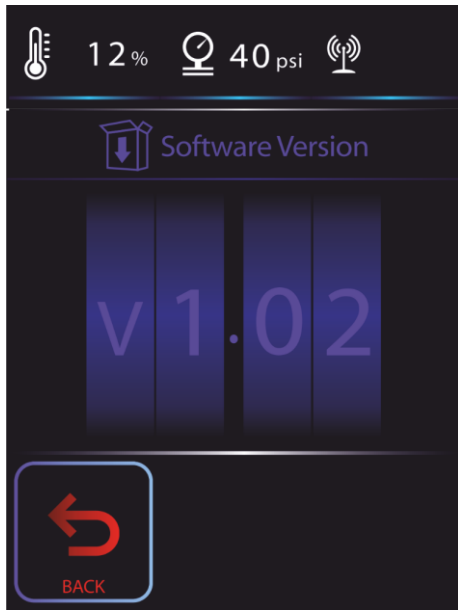

### 8.2.2 Wireless Signal



- 01) Press **CONFIRM** to enter the Wireless Signal menu.
- 02) The next window will show the problems if the wireless connection had been lost or show the signal strength of your Wifi-signal:

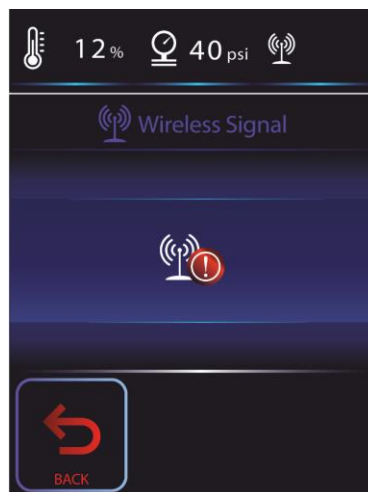
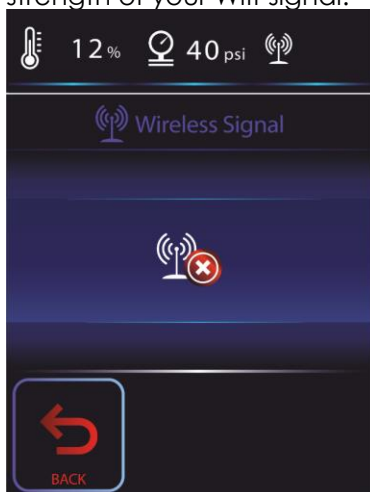

Problems wireless signal: W-DMX not assigned, No W-DMX signal or W-DMX Link lost (left to right)





4 different modes of wireless signal strength

## 8.2.3 Temperature



- 01) Press **CONFIRM** to enter the Temperature menu.
- 02) The next window will show you the current heater temperature.

## 8.2.4 Pressure



- 01) Press **CONFIRM** to enter the Pressure menu.
- 02) The next window will show you the current pressure in psi.

## 8.2.5 Operating Hours



01) Press **CONFIRM** to enter the Operating Hours menu.

02) The next window will show the total operating hours of your Mistique hazer.

## 8.3 Setting

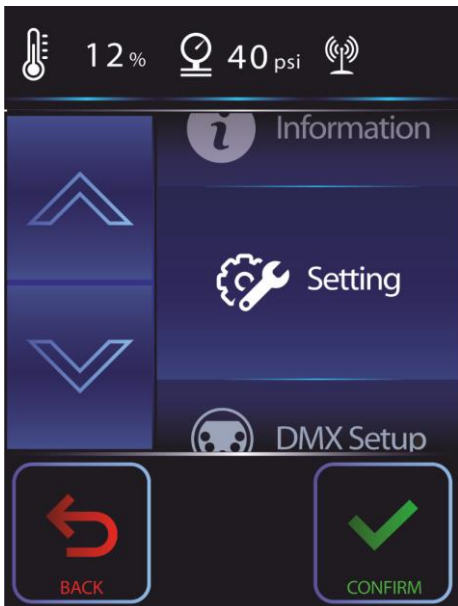

03) Press **CONFIRM** to enter the Information menu.

04) Press the **UP/DOWN** buttons to choose one of the 6 settings:

- LCD Backlight
- Auto Start
- Factory Reset
- Language
- Software Update
- Keypad Sound

### 8.3.1 LCD Backlight

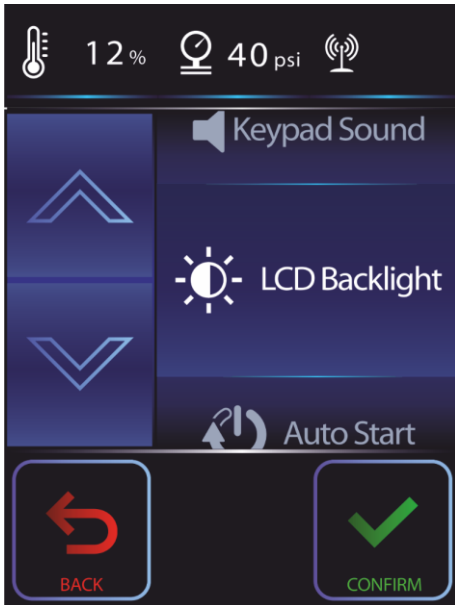

- 01) Press **CONFIRM** to enter the LCD Backlight menu.
- 02) Press **UP/DOWN** to select one of the 4 Backlight modes:
  - Auto Off
  - Low
  - Normal
  - High
- 04) Press **CONFIRM** to confirm your setting.

### 8.3.2 Auto Start

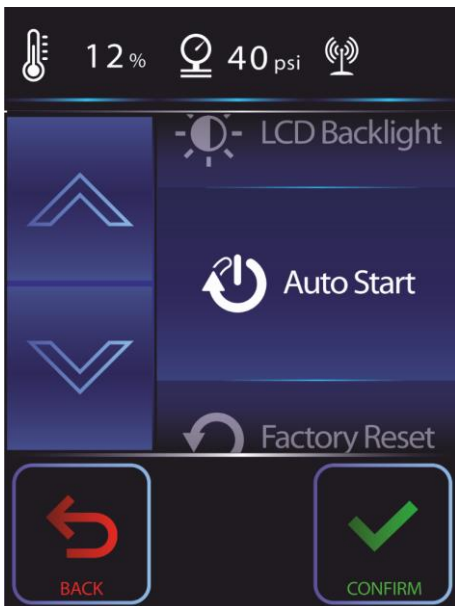

- 01) Press **CONFIRM** to enter the Auto Start menu.
- 02) Press **UP/DOWN** to select one of the 2 modes:
  - Off
  - On (When the heater reaches 100%, it will return to the latest operation mode)
- 03) Press **CONFIRM** to confirm your setting.

### 8.3.3 Factory Reset

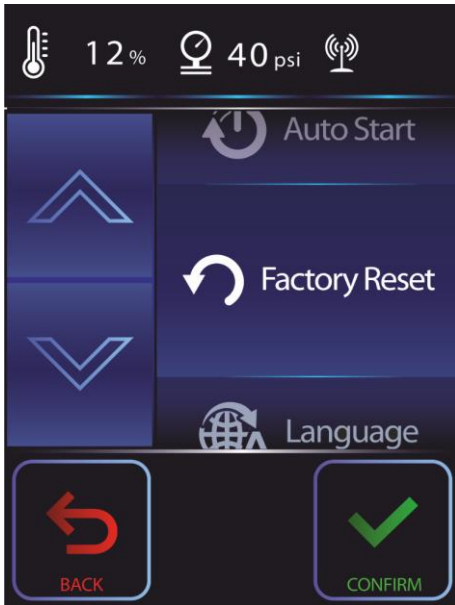

- 01) Press **CONFIRM** to enter the Factory Reset menu.
- 02) The next window will show:

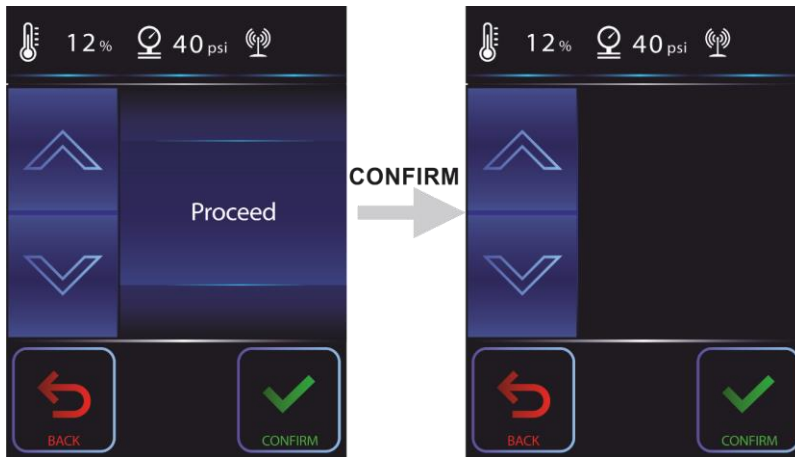

- 03) Press **CONFIRM** to confirm your setting.
- 04) The device will now reset itself.
- 05)

## 8.3.4 Language

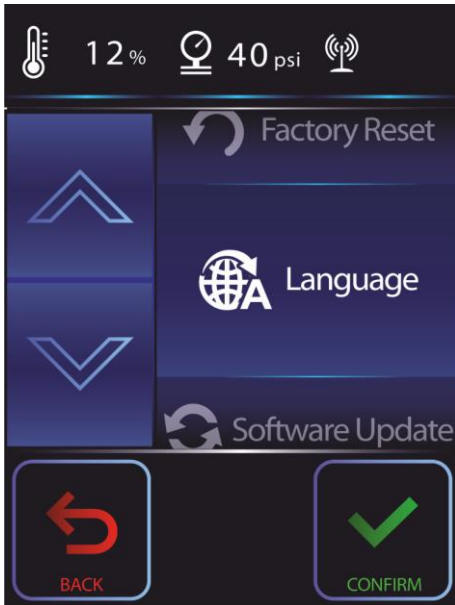

- 01) Press **CONFIRM** to enter the Language menu.
- 02) Press **UP/DOWN** to select one of the 2 language modes:
  - EN
  - ZH
- 03) Press **CONFIRM** to confirm your setting.

## 8.3.5 Software Update

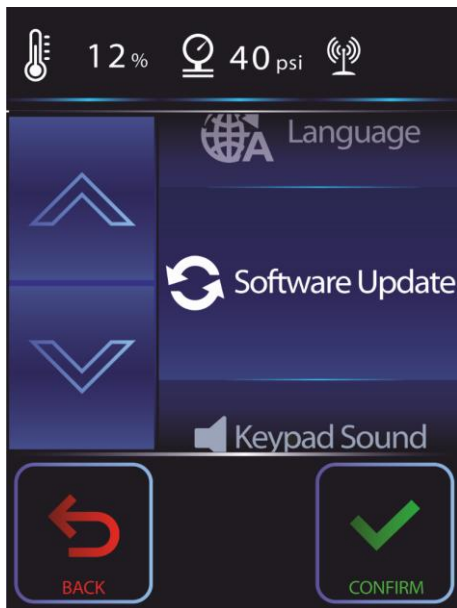

- 01) It is not possible to update the Mistique without contacting your dealer.
- 02) Press **CONFIRM** to enter the Software Update menu.
- 03) The next window will show:

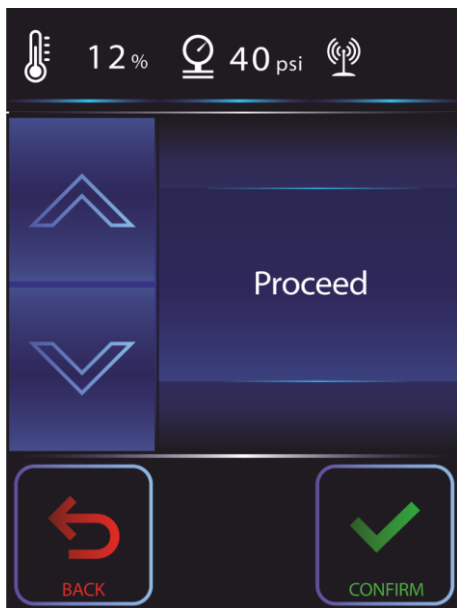

- 04) Press **CONFIRM** to go to the next step
- 05) The next window will show:

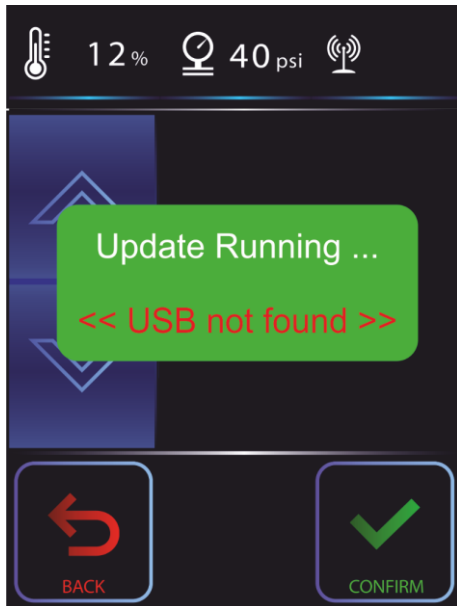

- 06) You cannot update the Mistique yourself.
- 07) Please ask your dealer if a newer software version exists.
- 08) If so, send the device back to your dealer to have it updated.
- 09) Press **CONFIRM** to confirm your setting.

### 8.3.6 Keypad Sound

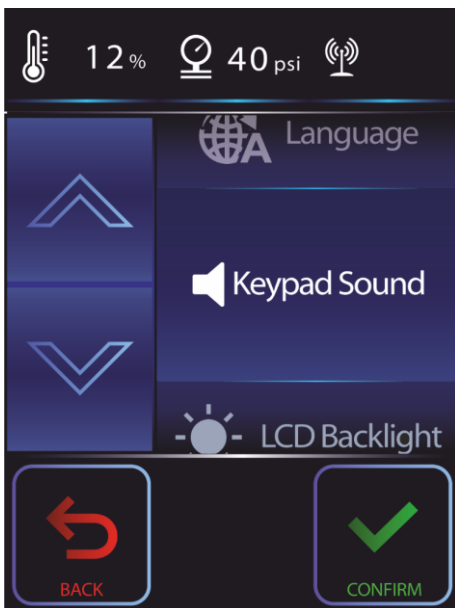

- 04) Press **CONFIRM** to enter the Keypad Sound menu.
- 05) Press **UP/DOWN** to select one of the 2 modes:
  - Stop
  - Start
- 06) Press **CONFIRM** to confirm your setting.

**DMX Channels****1 channel****Channel 1 – Output volume**

0-4 Off

5-255 5-40 psi

**3 channels****Channel 1 – Output volume**

0-4 Off

5-255 5-40 psi

**Channel 2 – Fan Speed**

0-4 Off

5-255 5-40 psi

**Channel 3 – Heating**

0-127 Off

128-255 On

**5 channels****Channel 1 – Output volume**

0-4 Off

5-255 5-40 psi

**Channel 2 – Fan Speed**

0-4 Off

5-255 5-40 psi

**Channel 3 – Heating**

0-127 Off

128-255 On

**Channel 4 – Operating Mode**

0-127 DMX control

128-192 Timer 1

193-255 Timer 2

**Channel 5 – Cleaning Mode**

0-127 Off

128-255 Cleaning function initiated 1 time



## Maintenance

---

The Mistique requires almost no maintenance. However, you should keep the unit clean. Disconnect the mains power supply and then wipe the cover with a damp cloth. Wipe the front panel with a damp cloth. Do not use alcohol or solvents. Do not immerse in liquid.

Keep connections clean. Disconnect electric power, and then wipe the connections with a damp cloth. Make sure connections are thoroughly dry before linking equipment or supplying electric power.

Do not allow the MHL-2 haze liquid to become contaminated. Always place the caps back on the haze liquid container and the haze machine liquid tank immediately after filling.

After every 40 hours of continuous operation, it is recommended to run a cleaning cycle.

### Automatic Cleaning Procedure

This device is equipped with an automatic pipe cleaning feature. It automatically cleans the residues in the pipes after each use. Hence it can significantly prevent the chances of clogging and prolongs the machine's product life cycle.

The standard cleaning cycle will take a few minutes. Therefore, do not turn off the device immediately after operating the device.

The automatic pipe cleaning procedure takes about 1 minute, whilst manually cleaning the device takes about 3 minutes.

### Performance Note:

Haze machines may sputter small amounts of haze occasionally during operation and for a about a minute after being turned off.

The device will use the automatically start the auto-clean function.

### Automatic Protection Mechanism

This device is equipped with an automatic Fail- Safe system to protect the haze machine.

- 01) The Mistique will only start operating when the heater reaches its working temperature, otherwise it remains in standby modus.
- 02) If an error occurs, the LCD display will show an error message (please see page xx ) and stop working until the error is cleared.
- 03) When the device overheats (up to 390°C), the system will shut down and lock up. Please turn OFF the device and stop working until the error is cleared.
- 04) The device will automatically show a reminder message on the LCD display when the pressure runs low (display low pressure). Please replace the gas bottle when this message appears.
- 05) The device comes with a de-pressure valve. The purpose of this device is to control the pressure of the machine's working temperature and prevents it for damage.

When the device stops working for unknown reasons, please check the message on the LCD display. Then turn off the device for 30-60 seconds before turning it back on for a simple reset. If it is still not working, please contact your dealer and send it back to your dealer for further testing and service.

### Fan Cleaning

Please clean the fan after a period of extensive use with a brush and compressed air.

## O-Ring Cleaning

Please keep the O-ring on the thread (below the screw cap of the tank) clean. This will prevent the airtight seal from leaking air and hereby causing decompression of the liquid tank.

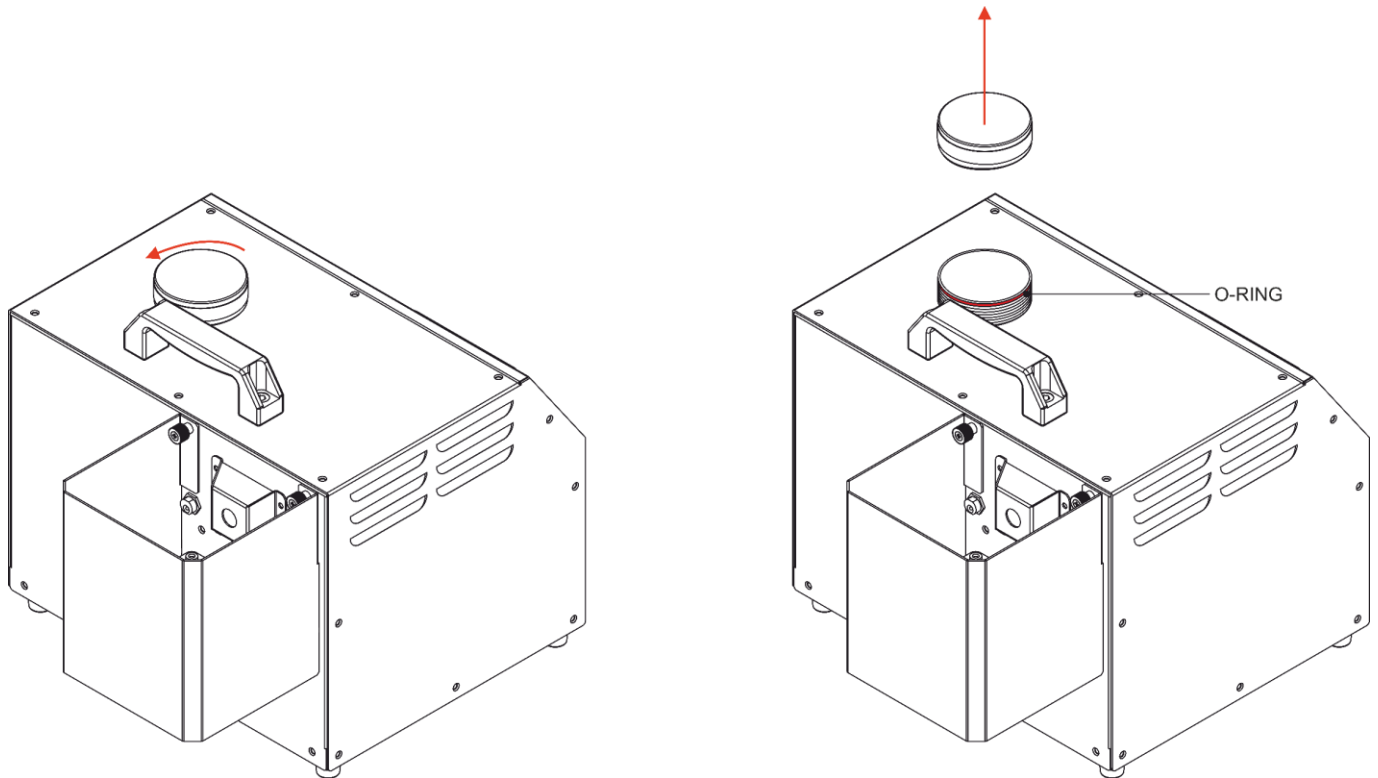

## Replacing a Fuse

You do not have to replace the fuse on this device as the fuse (T8a, 250V) is automatic.

- 01) Unplug the unit from electric power source.
- 02) In case of a power surge, short-circuit or inappropriate power supply, press the reset button located on the rear of the device, and the device will function normally.
- 03) Plug the unit from electric power source and turn the device on
- 04) Try to determine the cause of the problem, so that the situation does not happen in the future.

## Troubleshooting

This troubleshooting guide is meant to help solve simple problems.

Always monitor tank liquid level as you are blowing haze. Running a haze machine with no liquid can permanently damage the unit.

If a problem occurs, carry out the steps below in sequence until a solution is found. Once the unit operates properly, do not carry out following steps.

If the Mistique does not operate properly, refer servicing to a technician.

01) If you experience low output or no output at all, unplug immediately.





02) Check liquid level and power from the wall.

03) If all of the above appears to be O.K., plug the unit in again.

04) If you are unable to determine the cause of the problem, do not simply continue, as this may damage the unit.

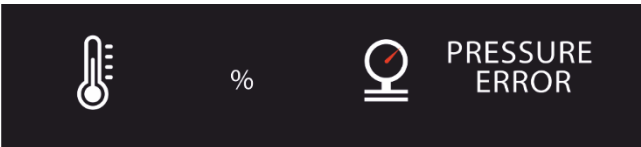
05) Return the machine to your Showtec dealer.

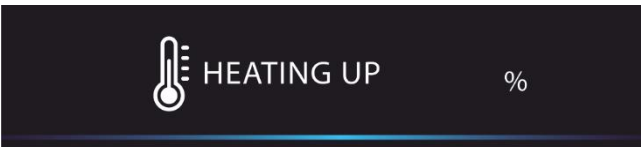
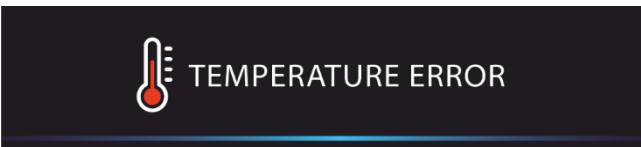
## Message List of Errors

	Ready
	Heating coil is on + detected pressure error
	Temperature error + detected pressure error
	Continuous heating
	Heating coil temperature error
	Pressure error

## Product Specification

Model:	Mistique
Input Voltage:	100-240VAC, 50/60Hz
Power consumption:	1250W max
Heating time:	under 8 min.
Maximum Output:	5000 cu.ft/min
Output Direction:	Up, down, forward
Output Regulation:	5-40psi
Tank capacity:	2,5 L
Liquid Type:	MHL-2 only
Liquid Consumption:	120ml/hour (@40psi)
Gas Type:	CO <sub>2</sub> or N <sub>2</sub>
Gas Consumption:	0,36Kg/hour (@ 40psi)
Gas Pressure:	50 to 60 psi / 3,4 to 4.1 bar max.
On Board:	Battery powered LCD TFT touchscreen
DMX Mode:	1, 3, 5 channels
Output volume:	30000 cu.ft/min
Warm-up time:	6 min
Automatic fuse:	8A/250V
Dimensions:	503 x 334 x 310 mm (LxWxH)
Weight:	17 kg
<b>Electro-mechanical effects</b>	
Mounting:	Mounting bracket
Housing:	Metal & Flame-retardant plastic
Power connection:	Neutrik Powercon True1 in- & output
Data Connection:	Neutrik XLR 5p & 3p in- & output
Gas Connection:	Male Q-lock
Ingress Protection:	IP-20
Fan Speed:	20-100%
Control Mode :	Manual mode, 2x Timer mode, DMX control, Wireless DMX control
Max. ambient temperature $t_a$ :	40°C
Max. housing temperature $t_B$ :	80°C
<b>Minimum distance:</b>	
Minimum distance from flammable surfaces:	0,5 m
Minimum distance to lighted object:	1 m

Design and product specifications are subject to change without prior notice.



Website: [www.Showtec.info](http://www.Showtec.info)  
 Email: [service@highlite.com](mailto:service@highlite.com)

## Dimensions

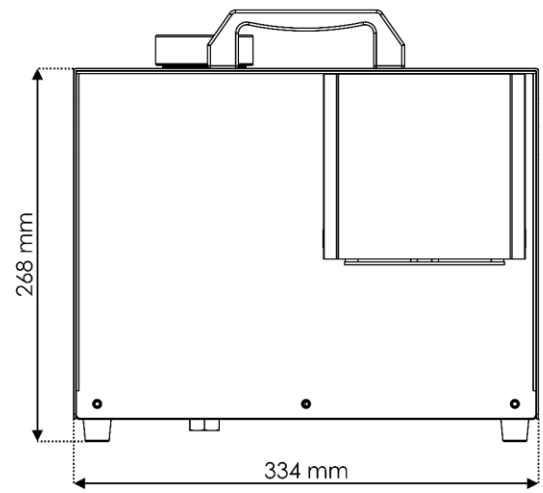
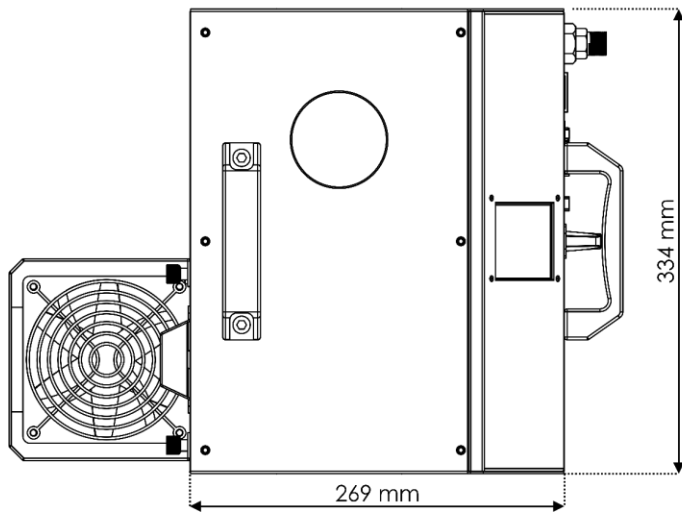
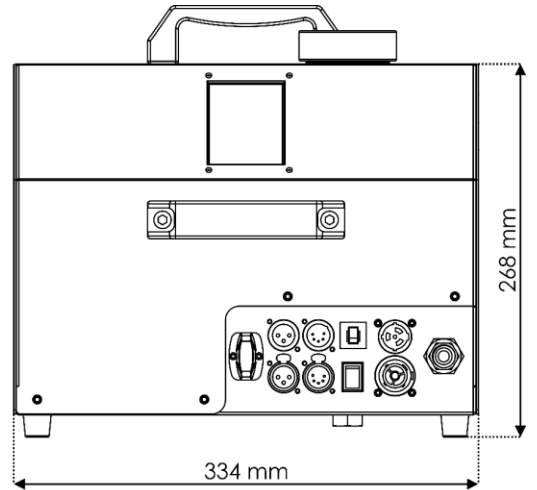
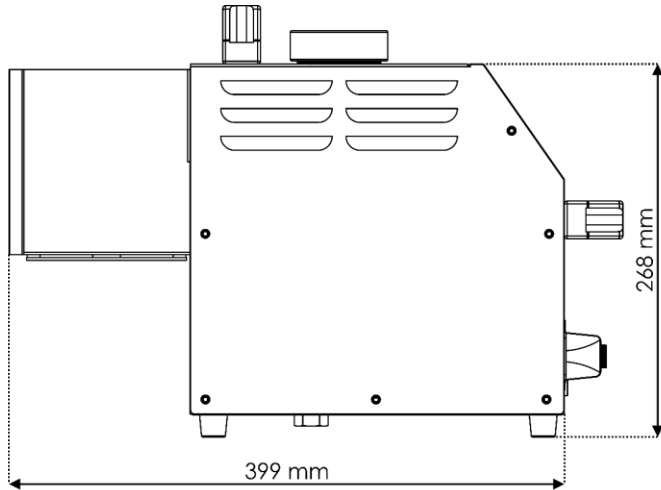







©2019 Showtec