

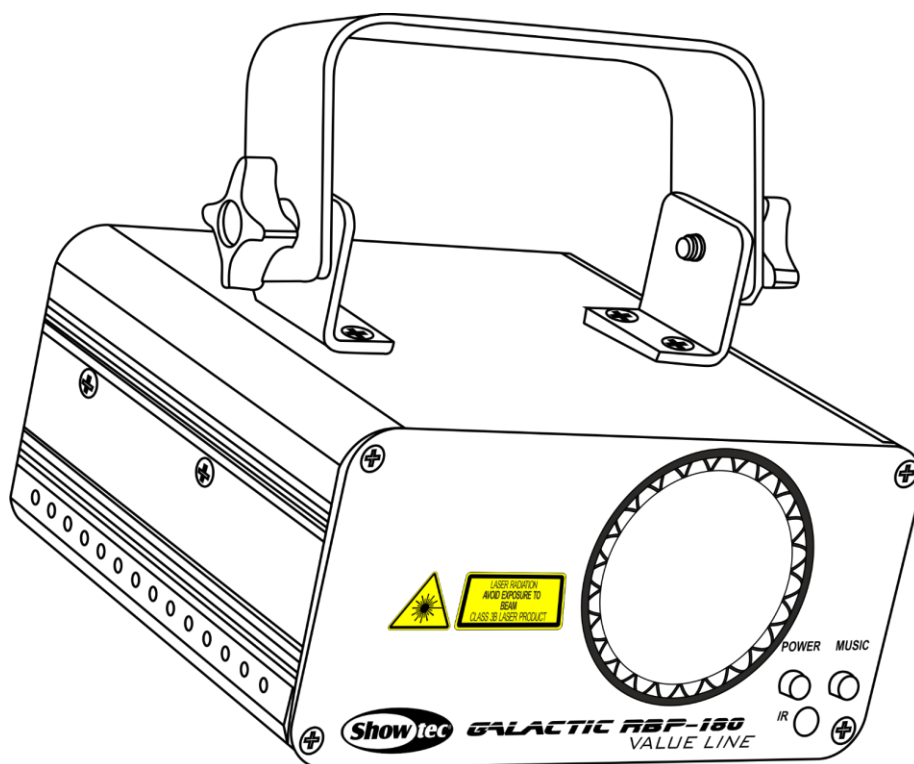

MANUAL



ENGLISH

Galactic RBP-180



V2

Ordercode: 51337

Table of contents

Warning	2
Unpacking Instructions	2
Safety Instructions	3
Operating Determinations	5
Laser safety for a Class 3B Laser Product	5
Rigging	7
Connection with the mains	7
Return Procedure	8
Claims	8
Description of the device	9
Features	9
Optional accessories	9
Overview	10
Backside	10
Installation	11
Set Up and Operation	11
Control Modes	12
One Galactic (Auto Program)	12
One Galactic (Sound-controlled)	12
Multiple Galactics (Master/Slave Mode)	13
Multiple Galactics (DMX Control)	14
Fixture Linking	15
Data Cabling	15
Control Panel	16
Control Mode	16
DMX Addressing	16
Menu Overview	17
Main Menu Options	17
1. Auto run programs/Sound-controlled programs	18
2. Sound sensitivity	18
3. DMX address	18
4. Slave mode	18
5. IR remote control mode	18
6. Test mode	18
Remote Control	19
DMX Channels	20
10 Channels	20
Patterns	22
Maintenance	23
Replacing the Fuse	23
Troubleshooting	23
No Light	23
No Response to DMX	23
Product Specifications	25
Dimensions	26

Warning

 **For your own safety, please read this user manual carefully before your initial start-up!** 



Unpacking Instructions

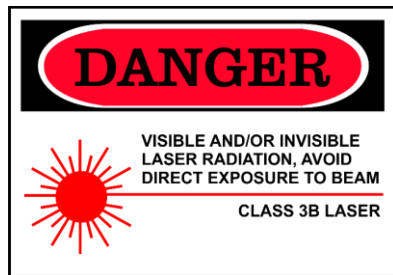
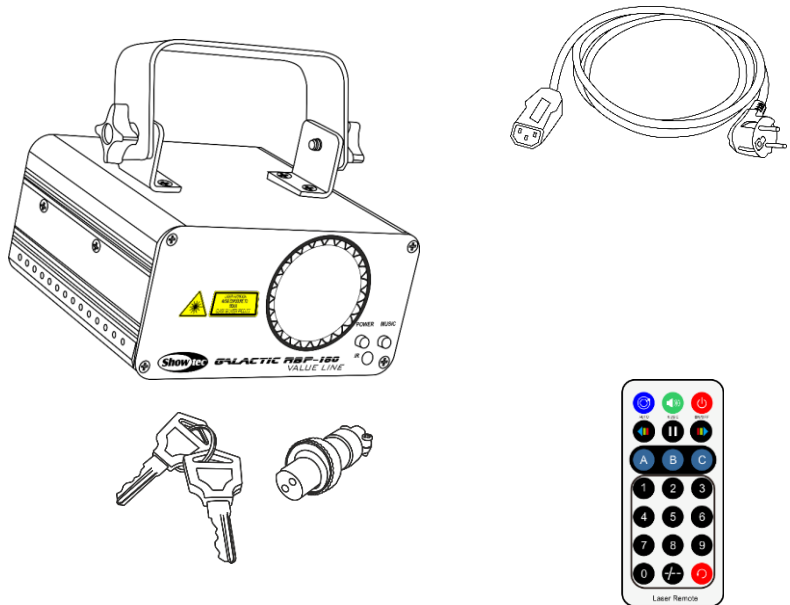

Immediately upon receiving this product, carefully unpack the carton and check the contents to ensure that all parts are present, and have been received in good condition. Notify the dealer immediately and retain packing material for inspection if any parts appear damaged from shipping or the carton itself shows signs of mishandling. Save the carton and all packing materials. In the event that a fixture must be returned to the factory, it is important that the fixture be returned in the original factory box and packing.

Your shipment includes:

- Showtec Galactic RBP-180
- IEC Power cable (1,5 m)
- 2 keys for the interlock
- Remote control plug
- IR Remote control
- User manual



 **CAUTION! Eyedamages!!!**
Never look directly into the lightsource!!!
Never project a single laser point!!! 

 **CAUTION!**
Keep this device away from rain and moisture!
Unplug mains lead before opening the housing! 

Safety Instructions

Every person involved with the installation, operation and maintenance of this device have to:

- be qualified
- follow the instructions of this manual



**CAUTION! Be careful with your operations.
With a dangerous voltage you can suffer
a dangerous electric shock when touching the wires!**



Before the initial start-up, please make sure that there is no damage caused by transportation. Should there be any, consult your dealer and do not use the device.

To maintain perfect condition and to ensure a safe operation, it is absolutely necessary for the user to follow the safety instructions and warning notes written in this manual.

Please consider that damages caused by manual modifications to the device are not subject to warranty.

This device contains no user-serviceable parts. Refer servicing to qualified technicians only.

IMPORTANT:

The manufacturer will not accept liability for any resulting damages caused by the non-observance of this manual or any unauthorized modification to the device.

- Never let the power cord come into contact with other cables! Handle the power cord and all connections with the mains with particular caution!
- Never modify, bend, mechanically strain, put pressure on, pull or heat up the power cord.
- Never strain the cable insert or the female part in the device. There must always be sufficient cable going to the device. Otherwise, the cable will be damaged, which can cause serious damage.
- Never remove warning or informative labels from the unit.
- Never use anything to cover the ground contact.
- Never place any material over the lens.
- Never look directly into the light source.
- Never leave any cables lying around.
- Never use the device during thunderstorms, unplug the device immediately.
- Never leave various parts of the packaging (plastic bags, polystyrene foam, nails, etc.) within children's reach, as they are potential sources of danger.
- Never aim the laser beam at people or animals!
- Never point a laser at aircraft. This is a federal offense.
- Never point un-terminated laser beams into the sky.
- Never open the laser housing. The high laser power levels inside of the protective housing can start fires, burn skin and will cause instant eye injury.
- Do not insert objects into air vents.
- Do not connect this device to a dimmer pack.
- Do not open the device and do not modify the device.
- Do not point lasers at highly reflective surfaces such as windows, mirrors and shiny metal. Even laser reflections can be hazardous.
- Do not expose the output optic (aperture) to cleaning chemicals.
- Do not use the laser if the laser appears to be emitting only one or two beams.
- Do not use the laser if housing is damaged or open, or if optics appear damaged in any way.
- Do not operate laser without first reading and understanding all safety and technical data in this manual. Never look into the laser aperture or laser beams.
- Do not switch the device on and off in short intervals, as this would reduce the device's life.
- Do not shake the device. Avoid brute force when installing or operating the device.

- After set up and prior to public use, test laser to ensure proper function. Do not use the laser if any defect is detected. Do not use, if the laser emits only one or two laser beams rather than dozens/hundreds, as this could indicate damage to the diffraction grating optic, and could allow emission of higher laser levels.
- Only use device indoors, avoid contact with water or other liquids.
- Only operate the fixture after having checked that the housing is firmly closed and all screws are tightly fastened.
- Only operate the device after having familiarized with its functions.
- Avoid flames and do not put close to flammable liquids or gases.
- Avoid eye or skin exposure to direct or scattered radiation of class 3B laser product.
- Always check the regulations when using a class 3B laser product.
- Always check and position the laser before anybody enters the room, when the laser is facing an area with people.
- Always keep case closed while operating.
- Always allow free air space of at least 50 cm around the unit for ventilation.
- Always disconnect power from the mains, when device is not used or before cleaning! Only handle the power cord by the plug. Never pull out the plug by tugging the power cord.
- Make sure that the device is not exposed to extreme heat, moisture or dust.
- Make sure that the available voltage is not higher than stated on the rear panel.
- Make sure that the power cord is never crimped or damaged. Check the device and the power cord from time to time.
- Make sure that the core diameter of extension cords and power cords is sufficient for the required power consumption of the device.
- If the external cable is damaged, it has to be replaced by a qualified technician.
- If the lens is obviously damaged, it has to be replaced, so that its functions are not impaired due to cracks or deep scratches.
- If device is dropped or struck, disconnect mains power supply immediately. Have a qualified engineer inspect for safety before operating.
- If the device has been exposed to drastic temperature fluctuation (e.g. after transportation), do not switch it on immediately. The arising condensation water might damage your device. Leave the device switched off until it has reached room temperature.
- If your Showtec device fails to work properly, discontinue use immediately. Pack the unit securely (preferably in the original packing material), and return it to your Showtec dealer for service.
- For adult use only. Device must be installed out of the reach of children. Never leave the unit running unattended.
- Never attempt to bypass the thermostatic switch or fuses.
- For replacement use fuses of same type and rating only.
- The operation of a class 3B laser show laser is only allowed if the show is controlled by a skilled and well-trained operator familiar with the data included in this manual.
- The user is responsible for correct positioning and operating of the laser. The manufacturer will not accept liability for damages caused by the misuse or incorrect installation of this device.
- This device falls under protection class I. Therefore it is essential to connect the yellow/green conductor to earth.
- The laser will only work between 15-35°C.
- After 3 hours working, you must shut off the laser and let the laser diode cool off for 30 minutes, otherwise the laser may become damaged and the warranty becomes void.
- Repairs, servicing and electric connection must be carried out by a qualified technician.
- WARRANTY: Till one year after date of purchase.

Operating Determinations

- This device is not designed for permanent operation. Consistent operation breaks will ensure that the device will serve you for a long time without defects.
- The minimum distance between light output and the illuminated surface must be bigger than 1 meter.
- In order to eliminate wear and improve the device's lifespan, during periods of non-use, completely disconnect from power source via breaker or by unplugging.
- The maximum ambient temperature $t_a = 35^\circ\text{C}$ must never be exceeded.
- The relative humidity must not exceed 50 % with an ambient temperature of 35°C .
- If this device is operated in any other way, than the one described in this manual, the product may suffer damages and the warranty becomes void.
- Any other operation may lead to dangers like short-circuit, burns, electric shock, crash etc.

You endanger your own safety and the safety of others!

Laser safety for a Class 3B Laser Product

Laser Light is different from any other light source with which you may be familiar with. The light from this product can potentially cause instant eye injury if not set up and used properly.

Laser light is thousands of times more concentrated than light from any other kind of light source. This concentration of light power can cause instant eye injuries, primarily by burning the retina (the light sensitive portion at the back of the eye). Even if you cannot feel "heat" from a laser beam, it can still potentially injure or blind you or your audience.

Even very small amounts of laser light are potentially hazardous even at long distances. Laser eye injuries can happen quicker than you can blink.

It is incorrect to think that because these laser products split the laser into hundreds of beams or the laser beam is scanned out in high speed, that an individual laser beam is safe for eye exposure. This laser product uses dozens of milliwatts of laser power (Class 3B levels internally). Many of the individual beams are potentially hazardous to the eyes.

It is also incorrect to assume that because the laser light is moving, it is safe. This is not true. Nor, do the laser beams always move. Since eye injuries can occur instantly, it is critical to prevent the possibility of any direct eye exposure. According to the laser safety regulation, it is not legal to aim Class 3B lasers in areas which people can get exposed. This is true even if it is aimed below people's faces, such as on a dance floor.

CAUTION! Only Laser Safety Officers who are officially certified by a regulatory body or authorized training organization are allowed to use class 3B lasers in public. The Laser Safety Officer is responsible for all aspects when using this laser, including following all locally applicable safety laws and regulations. The manufacturer will not accept liability for damages caused by the misuse or incorrect installation of this laser.



CAUTION: AVOID EXPOSURE TO BEAM: Avoid direct eye contact with laser light. Never intentionally expose your eyes or others to direct laser radiation.

Compliance Statement

Your laser has been designed to comply with FDA and IEC Standards for its classification. The laser is a Class 3B laser product.

Laser Safety and Compliance Information

The laser is manufactured to comply with the IEC 60825-1 and in accordance with U.S. Food and Drug Administration (FDA) Standards Listed under FDA Document 21 CFR 1040 and subsequent laser notices.

Product Classification and Manufacturing Label Identification

Laser Classification	Class 3B
Cooling	Cooling fans and TE Cooling
Laser medium	Wavelength 650nm / Red (LD GeAlAs); Output >100mW Wavelength 450nm / Blue (LD GeAs); Output >80mW
Output	180mW
Beam Diameter	<5mm at aperture
Pulse Data All pulses	<4Hz (>0.25sec)
Divergence (each beam)	<2 mrad
Divergence (total light)	<90 degrees

The legal requirements for using laser entertainment products vary from country to country. The user is responsible for the legal requirements at the location/country of use.

Further guidelines and safety programs for safe use of lasers can be found in the ANSI Z136.1 Standard "For Safe Use of Lasers", available from www.lia.org/. Many local governments, corporations, agencies, military and others, require all lasers to be used under the guidelines of ANSI Z136.1. Laser Display guidance can be obtained via the International Laser Display Association, www.ilda.com/index.htm.

CAUTION: The use of corrective eye wear or optics for viewing at distances such as telescopes or binoculars within a distance of 100mm may pose an eye hazard.



This laser product is a Class 3B laser and has an interlocked housing.



There are no user serviceable parts inside. Tampering or removing warranty seals will void your products limited warranty.



Combo label with the Product Model Number, Serial Number, Date of Manufacturing, Laser Light Warning Label, Warranty Void Label and Interlocked Housing Label

Proper Usage Safety and Compliance Information

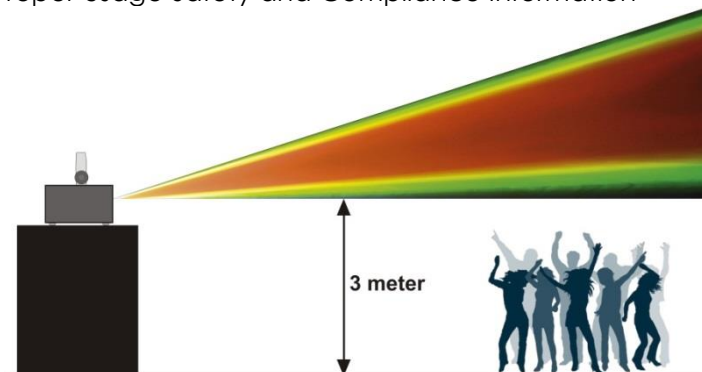

According to FDA Regulations you should operate this product as stated on the left.

Rigging

Please follow the European and national guidelines concerning rigging, trussing and all other safety issues.

Do not attempt the installation yourself !

Always let the installation be carried out by an authorized dealer !

Procedure:

- If the laser is lowered from the ceiling or high joists, professional trussing systems have to be used.
- Use a clamp to mount the laser, with the mounting-bracket, to the trussing system.
- The laser must never be fixed swinging freely in the room.
- The installation must always be secured with a safety attachment, e.g. an appropriate safety net or a safety cable.
- When rigging, derigging or servicing the laser, always make sure that the area below the installation is unavailable for any unauthorized persons.

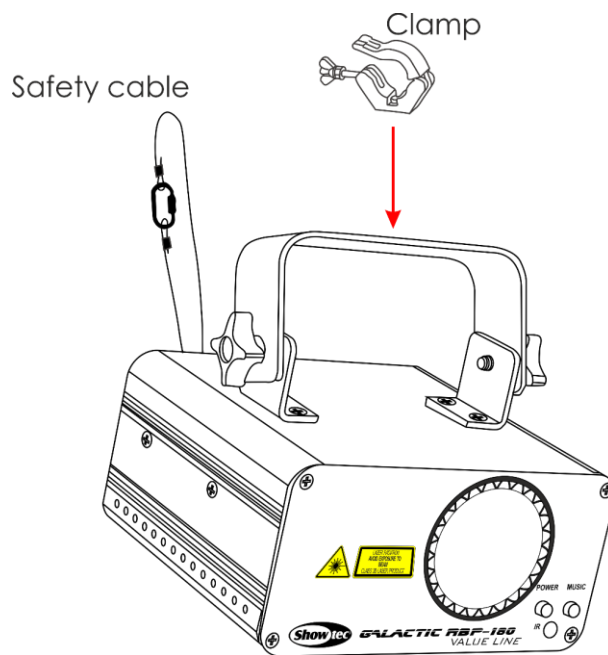

The Galactic can be placed on a flat stage floor or mounted to any kind of truss with a clamp.

Improper installation can cause serious damage to people and property!

Connection with the mains

Connect the device to the mains with the power-plug.

Always pay attention, that the right color cable is connected to the right place.

International	EU Cable	UK Cable	US Cable	Pin
L	BROWN	RED	YELLOW/COPPER	PHASE
N	BLUE	BLACK	SILVER	NEUTRAL
⊕	YELLOW/GREEN	GREEN	GREEN	PROTECTIVE GROUND

Make sure that the device is always properly connected to the earth!

Improper installation can cause serious injuries and/or damage of property!



Return Procedure



Returned merchandise must be sent prepaid and in the original packing, call tags will not be issued. Package must be clearly labeled with a Return Authorization Number (RMA number). Products returned without an RMA number will be refused. Highlite will not accept the returned goods or any responsibility. Call Highlite 0031-455667723 or mail offersales@highlite.nl and request an RMA prior to shipping the fixture. Be prepared to provide the model number, serial number and a brief description of the cause for the return. Be sure to properly pack fixture, any shipping damage resulting from inadequate packaging is the customer's responsibility. Highlite reserves the right to use its own discretion to repair or replace product(s). As a suggestion, proper UPS packing or double-boxing is always a safe method to use.

Note: If you are given an RMA number, please include the following information on a piece of paper inside the box:

- 01) Your name
- 02) Your address
- 03) Your phone number
- 04) A brief description of the symptoms

Claims

The client has the obligation to check the delivered goods immediately upon delivery for any shortcomings and/or visible defects, or perform this check after our announcement that the goods are at their disposal. Damage incurred in shipping is the responsibility of the shipper; therefore the damage must be reported to the carrier upon receipt of merchandise.

It is the customer's responsibility to notify and submit claims with the shipper in the event that a fixture is damaged due to shipping. Transportation damage has to be reported to us within one day after receipt of the delivery.

Any return shipment has to be made post-paid at all times. Return shipments must be accompanied with a letter defining the reason for return shipment. Non-prepaid return shipments will be refused, unless otherwise agreed in writing.

Complaints against us must be made known in writing or by fax within 10 working days after receipt of the invoice. After this period complaints will not be handled anymore.

Complaints will only then be considered if the client has so far complied with all parts of the agreement, regardless of the agreement of which the obligation is resulting.

Description of the device

Features

The Showtec Galactic RBP-180 is a laser effect with high output and great effects.

- When using multiple units together, you can make a great and cost effective beam-show
- Sound-controlled via built-in microphone
- IR remote control included
- 32 Patterns and built-in shows
- Master / Slave possibility with other value line lasers
- Power Input: 100-240V AC, 50/60Hz
- Power Consumption: 17W
- Laser Class: 3B
- Laser Color: Red, Blue, Purple
- Laser Power: 180mW (100mW 650nm Red, 80mW 450nm Blue)
- Scan Angle: +-30°
- Scan speed: stepping motor
- Control Modes: Auto, Master/Slave, Sound, DMX-512
- Control protocol: DMX-512
- DMX channels: 10 channels
- On Board: 3-digit LED display for easy setup
- Protection rate: IP-20
- Housing: Compact strong metal housing
- Cooling: Fan/Convection
- Connections: IEC connector (IN), 3-pin XLR (IN/OUT)
- Safety Features: Key switch, Interlock
- Fuse: T1A/250V
- Dimensions: 145 x 160 x 155 mm (LxWxH) (incl. bracket)
- Weight: 1,3 Kg

Note: Knowledge of DMX is required to fully utilize this unit.

Optional accessories

[51316](#) Remote Interlock

Overview

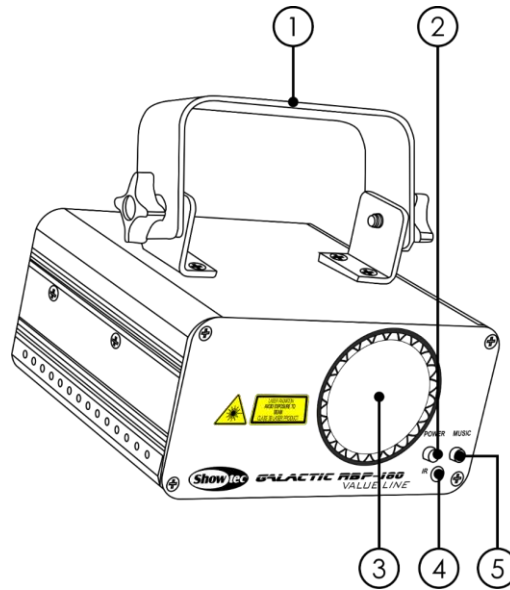

Fig. 01

- 01) Mounting bracket with inclination screws
- 02) Power LED indicator (Red)
- 03) Laser lens
- 04) IR remote sensor
- 05) Music-control LED indicator (Blue)

Backside

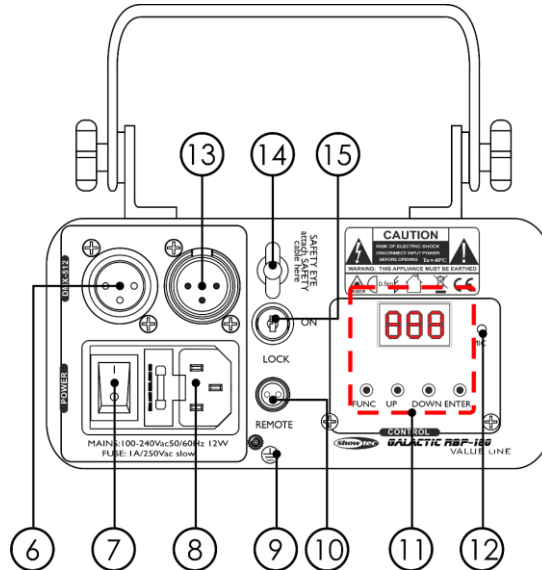

Fig. 02

- 06) 3-pin DMX signal connector OUT
- 07) Power switch ON/OFF
- 08) IEC Power connector AC 100-240V + Fuse T1A/250V
- 09) Ground/earth connection
- 10) Remote control plug
- 11) Control panel + menu buttons
- 12) Built-in microphone
- 13) 3-pin DMX signal connector IN
- 14) Safety eye
- 15) Interlock

Installation

Remove all packing materials from the Galactic. Check if all foam and plastic padding is removed. Connect all cables.

Do not supply power before the whole system is set up and connected properly.

Always disconnect from electric mains power supply before cleaning or servicing.

Damages caused by non-observance are not subject to warranty.

Set Up and Operation

Follow the directions below, as they pertain to your preferred operation mode.

Before plugging the unit in, always make sure that the power supply matches the product specification voltage. Do not attempt to operate a 120V specification product on 230V power, or vice versa. Connect the device to the main power supply. The device can be music-controlled by its built-in microphone.

The Interlock plug/remote plug and safety keys are included in the box.

The interlock is the "included-in-the-box" successor for the optional remote interlock ([51316](#)).

 **They should be kept with the Galactic laser !!!** 

The following safety precautions should be followed:

- The remote control plug should be placed on the backside (10) of your Galactic laser.
- The keys should be put into the lock (15) of your Galactic laser.

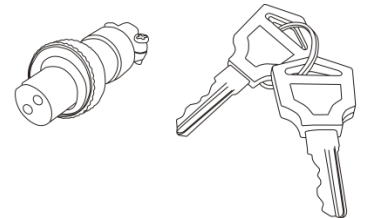

 **Warning** 

If the plug is not connected, your laser will not function.

If the key is not set to ON, your laser will not function.

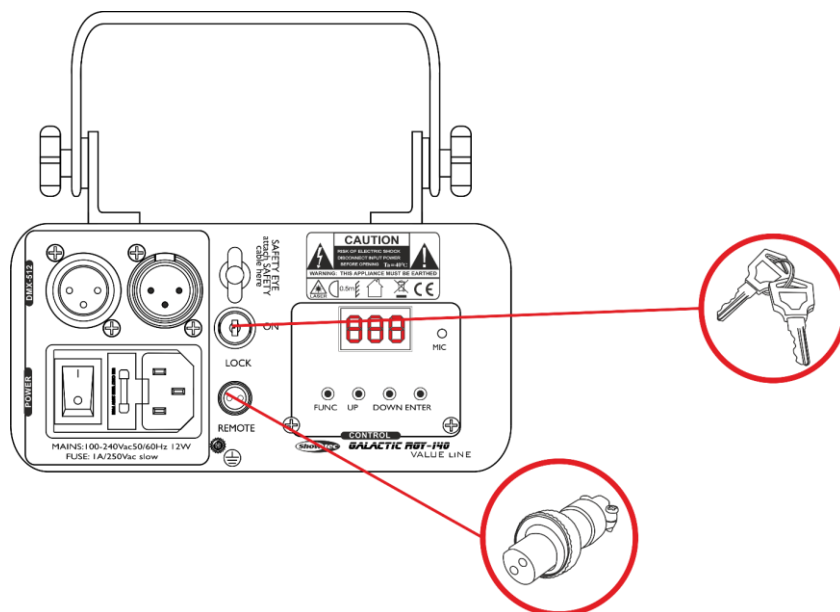

Exclusion of liability

Be aware that in some countries, there are additional regulations, regarding the use of laser devices. Therefore, we strongly advise you to verify your national laws with your authorities: We do not take any responsibility for eventual discrepancies, changes or adaptations regarding lawful use of laser devices.

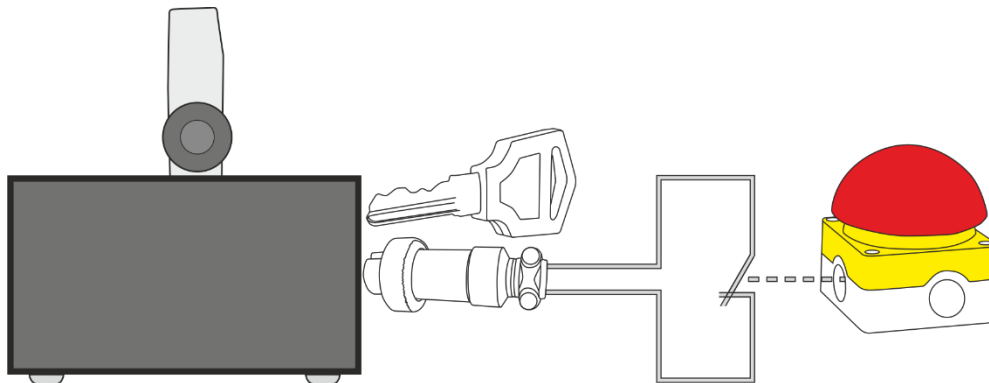

Control Modes

There are 4 modes:

- Auto Program
- Sound-controlled
- Master/Slave
- DMX-512 (10CH)

One Galactic (Auto Program)

- 01) Fasten the effect light onto firm trussing. Leave at least 0,5 meter on all sides for air circulation.
- 02) Always use a safety cable (ordercode 70140 / 70141).
- 03) Plug the end of the electric mains power cord into a proper electric power supply socket.
- 04) When the Galactic is not connected by a DMX-cable, it functions as a stand-alone device. Please see page 18 for more information about the Auto built-in programs.

One Galactic (Sound-controlled)

- 01) Fasten the effect light onto firm trussing. Leave at least 0,5 meter on all sides for air circulation.
- 02) Always use a safety cable (ordercode 70140 / 70141).
- 03) Plug the end of the electric mains power cord into a proper electric power supply socket.
- 04) When the Galactic is not connected with a DMX-cable, it functions as a stand-alone device. Please see page 18 for more information about the Sound-controlled mode.

Multiple Galactics (Master/Slave Mode)

- 01) Fasten the effect light onto firm trussing. Leave at least 0,5 meter on all sides for air circulation.
- 02) Always use a safety cable (ordercode 70140 / 70141).
- 03) Plug the end of the electric mains power cord into a proper electric power supply socket.
- 04) Use a 3-pin XLR cable to connect the Galactics and other devices.

The pins:



- 01) Earth
- 02) Signal (-)
- 03) Signal (+)

- 05) Link the units as shown in Fig. 03, connect a DMX signal cable from the first unit's DMX "out" socket to the second unit's "in" socket. Repeat this process to link the second, third and fourth unit. You can use the same functions on the master device as described on pages 18 (Auto Program, Sound-controlled). This means on the master device you can set your desired operation Mode and all slave devices will react the same as the master device.

Multiple Galactics Master/Slave Set Up

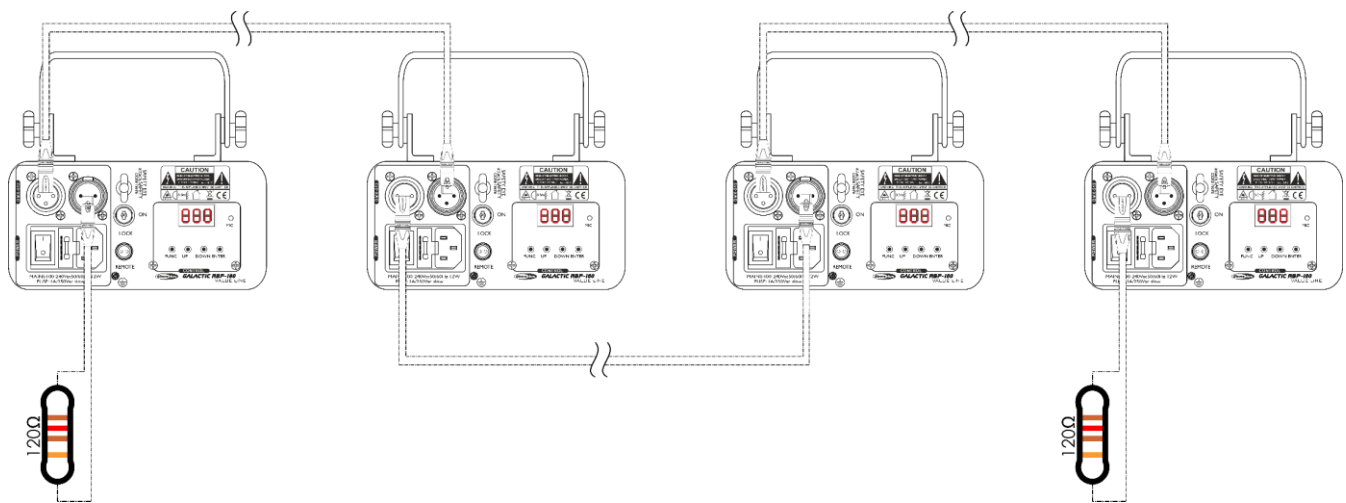
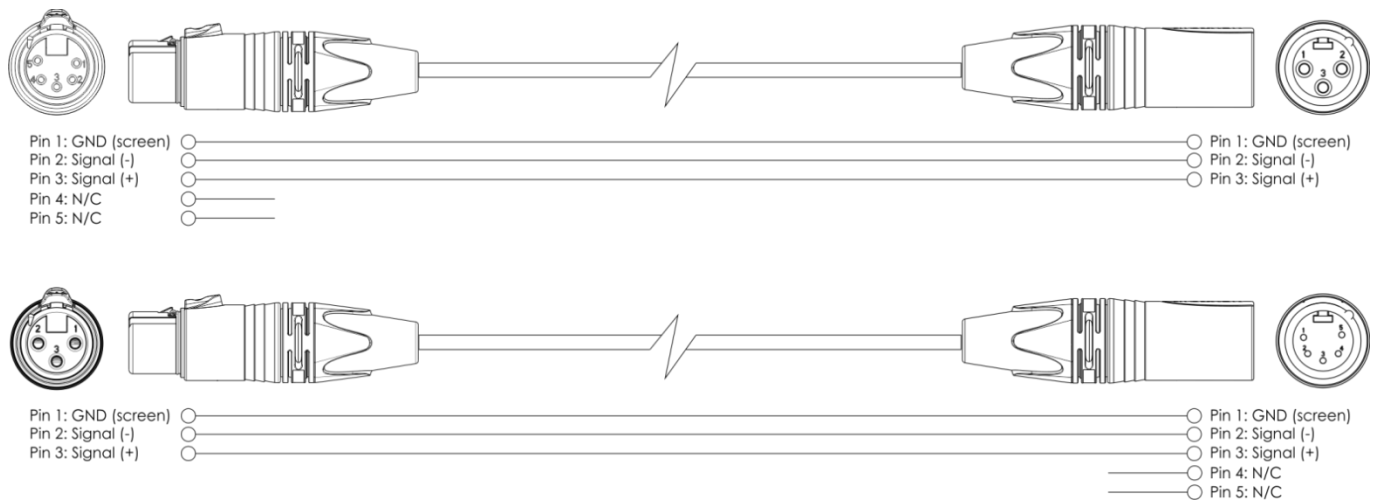

Fig. 03

Multiple Galactics (DMX Control)

- 01) Fasten the effect light onto firm trussing. Leave at least 0,5 meter on all sides for air circulation.
- 02) Always use a safety cable (ordercode 70140 / 70141).
- 03) Plug the end of the electric mains power cord into a proper electric power supply socket.
- 04) Use a 3-p XLR cable to connect the Galactics and other devices.



- 05) Link the units as shown in Fig. 04, Connect a DMX signal cable from the first unit's DMX "out" socket to the second unit's "in" socket. Repeat this process to link the second, third and fourth unit.
- 06) Supply electric power: Plug electric mains power cords into each unit's IEC socket, then plug the other end of the mains power cord into proper electric power supply sockets, starting with the first unit. Do not supply power before the whole system is set up and connected properly.

Multiple Galactics DMX Set Up

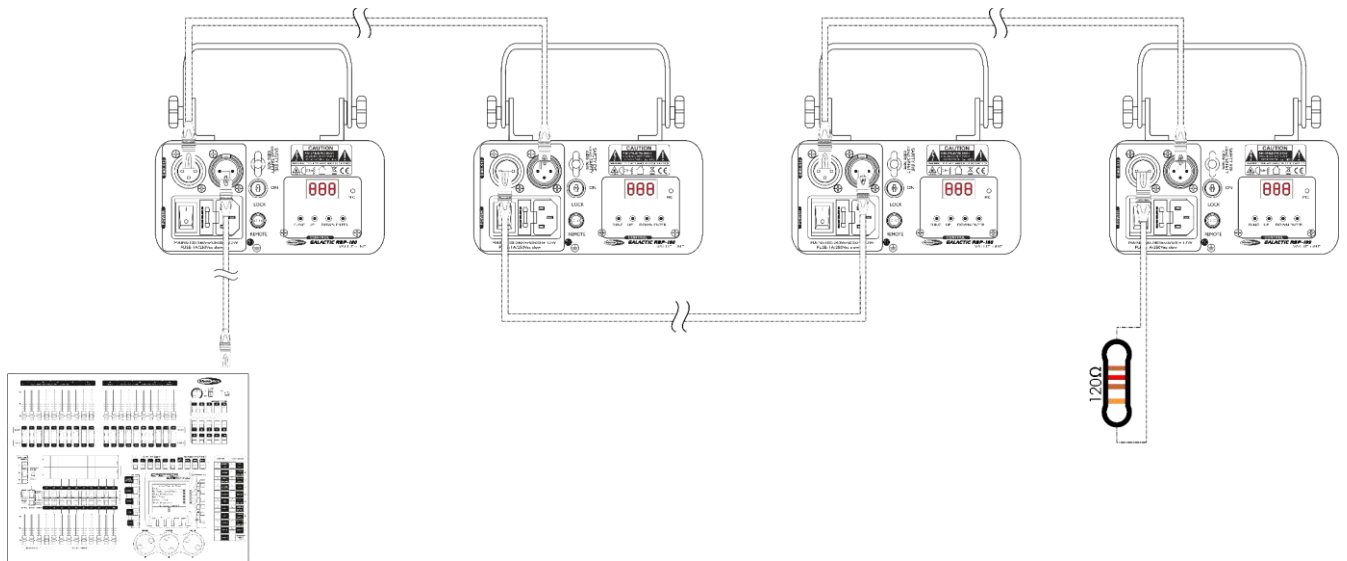

Fig. 04

Note: Link all cables before connecting electric power

Fixture Linking

You will need a serial data link to run light shows of one or more fixtures using a DMX-512 controller or to run synchronized shows on two or more fixtures set to a master/slave operating mode. The combined number of channels required by all the fixtures on a serial data link determines the number of fixtures the data link can support.

Important: Fixtures on a serial data link must be daisy-chained in a single line. To comply with the EIA-485 standard, no more than 30 devices should be connected on one data link. Connecting more than 30 fixtures on one serial data link without the use of a DMX optically isolated splitter may result in deterioration of the digital DMX signal.

Maximum recommended DMX data link distance: 100 meters
Maximum recommended number of fixtures on a DMX data link: 30 fixtures



Data Cabling

To link fixtures together, you must obtain data cables. You can purchase DAP Audio certified DMX cables directly from a dealer/distributor or construct your own cable. If you choose to create your own cable please use data-grade cables that can carry a high quality signal and are less prone to electromagnetic interference.

DAP Audio DMX Data Cables

- DAP Audio Basic microphone cable for allround use. bal. XLR/M 3-pin > XLR/F 3-pin. **Ordercode** FL01150 (1,5 m), FL013 (3 m), FL016 (6 m), FL0110 (10 m), FL0115 (15 m), FL0120 (20 m).
- DAP Audio X-type data cable XLR/M 3-pin > XLR/F 3-pin. **Ordercode** FLX0175 (0,75 m), FLX01150 (1,5 m), FLX013 (3 m), FLX016 (6 m), FLX0110 (10 m).
- DAP Audio cable for the demanding user with exceptional audio-qualities and connector made by Neutrik®. **Ordercode** FL71150 (1,5 m), FL713 (3 m), FL716 (6 m), FL7110 (10 m).
- DAP Audio cable for the demanding user with exceptional audio-qualities and connector made by Neutrik®. **Ordercode** FL7275 (0,75 m), FL72150 (1,5 m), FL723 (3 m), FL726 (6 m), FL7210 (10 m).
- DAP Audio 110 Ohm cable with digital signal transmission. **Ordercode** FL0975 (0,75 m), FL09150 (1,5 m), FL093 (3 m), FL096 (6 m), FL0910 (10 m), FL0915 (15 m), FL0920 (20 m).
- DAP Audio data cable FL08 DMX/AES-EBU, XLR/M 5-pin > XLR/F 5-pin. **Ordercode** FL08150 (1,5 m), FL083 (3 m), FL086 (6 m), FL0810 (10 m), FL0820 (20 m).
- DAP Audio DMX adapter: 5-pin > 3-pin. **Ordercode** FLA29.
- DAP Audio DMX adapter: 3-pin > 5-pin. **Ordercode** FLA30.
- DAP Audio DMX Terminator 3-pin. **Ordercode** FLA42.
- DAP Audio DMX Terminator 5-pin. **Ordercode** FLA43.

The Galactic RBP-180 can be operated with a controller in **control mode** or without the controller in **stand-alone mode**.

Control Panel

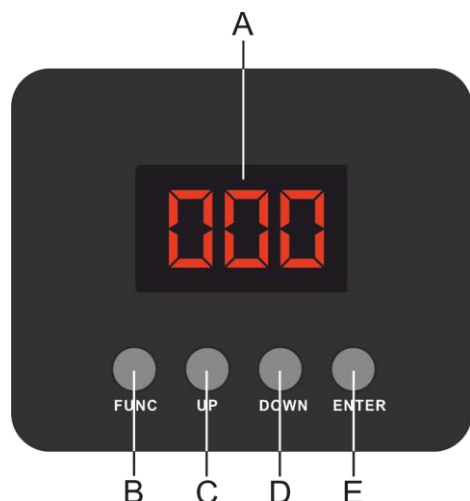

- A) LED display
- B) FUNC button
- C) UP button
- D) DOWN button
- E) ENTER button

Fig. 05

Control Mode

The fixtures are individually addressed on a data-link and connected to the controller. The fixtures respond to the DMX signal from the controller. (When you select the DMX address and save it, the controller will display the saved DMX address the next time.)

DMX Addressing

The control panel on the front side of the base allows you to assign the DMX fixture address, which is the first channel from which the Galactic will respond to the controller.

Please note when you use the controller, the unit has **10** channels.

When using multiple Galactics, make sure you set the DMX addresses right.

Therefore, the DMX address of the first Galactics should be **1(001)**; the DMX address of the second Galactic should be **1+10=11 (011)**; the DMX address of the third Galactic should be **11+10=21 (021)**, etc. Please, be sure that you do not have any overlapping channels in order to control each Galactic correctly. If two or more Galactics are addressed similarly, they will work similarly.

Controlling:

After having addressed all Galactic fixtures, you may now start operating these via your lighting controller.

Note: After switching on, the Galactic will automatically detect whether DMX-512 data is received or not. If there is no data received, the problem may be:

- The XLR cable from the controller is not connected with the input of the Galactic.
- The controller is switched off or defective, the cable or connector is defective, or the signal wires are swapped in the input connector.

Note: It is necessary to insert an XLR termination plug (with 120 Ohm) in the last fixture in order to ensure proper transmission on the DMX data link.

Menu Overview

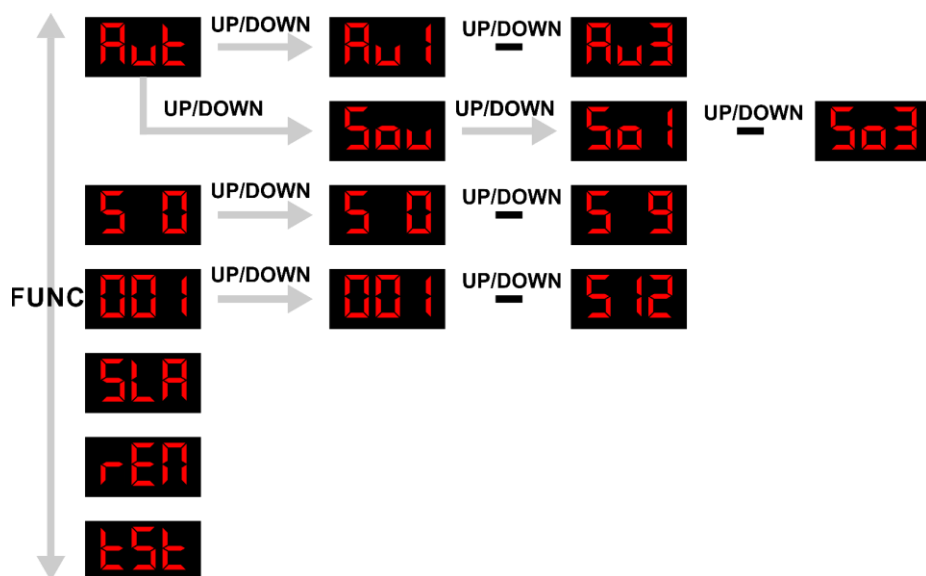



The Galactic RBP-180 will only show its version number at start-up !

V12

Main Menu Options

Aut	Auto run programs/Sound-controlled programs
50	Sound sensitivity
001	DMX address
SLA	Slave mode
7EN	IR remote control mode
t5t	Test mode

 You can only change a certain setting when the display is blinking. 
 If you cannot change a certain value, please press the FUNC button once and then change the value.

1. Auto run programs/Sound-controlled programs

In this menu you can start several Auto run programs or Sound-controlled programs.

- 01) Press the **FUNC** button until the display shows **AuE**.
- 02) Press the **UP/DOWN** buttons to choose between **Au1** ^{UP/DOWN} **Au3**.
- 03) Choose the desired built-in program and press the **ENTER** button to confirm.
- 04) The Galactic will immediately start the desired Auto run program.
- 05) Press the **UP/DOWN** buttons until the display shows **Sou**.
- 06) Press the **UP/DOWN** buttons to choose between **Sou1** ^{UP/DOWN} **Sou3**.
- 07) Choose the desired built-in program and press the **ENTER** button to confirm.
- 08) The Galactic will immediately start the desired Sound-controlled program.



The software will now run a pre-programmed laser show.
The speed and the characteristics of the show cannot be modified in this mode.



2. Sound sensitivity

In this menu you can set the sensitivity of the Sound-controlled program.

- 01) Press the **FUNC** button until the display shows **50**.
- 02) Press the **UP/DOWN** buttons to choose between **50** ^{UP/DOWN} **59**, from low sensitivity to high sensitivity.
- 03) Choose the desired sensitivity and press the **ENTER** button to confirm.
- 04) The Galactic will immediately adjust the sensitivity of the Sound-controlled program.

3. DMX address

In this menu you can set the DMX address.

- 01) Press the **FUNC** button until the display shows **001**.
- 02) Press the **UP/DOWN** buttons to choose the desired DMX address, the adjustment range is between **001** ^{UP/DOWN} **512**.
- 03) Set the desired DMX address and press the **ENTER** button to confirm.

4. Slave mode

In this menu you can set the device as a Slave.

- 01) Press the **FUNC** button until the display shows **SLA**.
- 02) Press the **ENTER** button to confirm.
- 03) If the device has not been set to slave, it is automatically classified as a master device. If the device has been set to slave, it will react the same as its master device.

5. IR remote control mode

In this menu you can activate the IR-remote mode.

- 01) Press the **FUNC** button until the display shows **REM**.
- 02) Press the **ENTER** button to confirm.
- 03) In any standalone mode (excepted REM and SLA), press ON/OFF for 2 seconds to activate the remote function.
- 04) Please see page 19 about the functions of your remote control.

6. Test mode

With this menu you can activate the automatic test program.

- 01) Press the **FUNC** button until the display shows **TEST**.
- 02) Press the **ENTER** button to confirm.
- 03) The Galactic will immediately start the built-in test program.

Remote Control

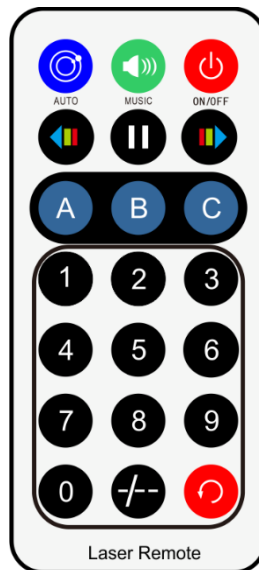

Button	Function	Description
	On / Off	Press the ON/OFF button for 2 seconds to activate the different modes except the Slave mode.
	Auto programs mode	Press the button to activate Auto program.
	Sound-controlled Mode	Press the button to activate Sound-controlled program, if the device receives a sound signal, the Music LED indicator on the front will blink (Blue LED).
	Sensitivity Sound-controlled mode	Press the buttons to set the sensitivity, from low (1) to high (9) sensitivity.
	Pattern change	Press the buttons to show or change the 32 built-in patterns.
	Color settings	Press one of the buttons to choose the desired built-in color of the laser.
	Preset patterns	Press the buttons to choose the desired built-in pattern (32).
	Pattern switch	Press the button to switch between the current pattern and the last chosen pattern.
	Pause	Press the button to pause the current show.

DMX Channels

10 Channels

Channel 1 – Auto Programs / Sound programs

0-29	Auto program Red, Green and Yellow
30-59	Auto program Green
60-89	Auto program Red
90-119	Auto program Yellow
120-149	Sound program Red, Green and Yellow
150-179	Sound program Green
180-209	Sound program Red
210-239	Sound program Yellow
240-255	DMX mode

Channel 2 – 32 Patterns (CH1 must be set between 240-255 and CH3 between 25-255)

0-255	32 Individual patterns (For exact values see page 22)
-------	---

Channel 3 – Colors

0-24	Blackout
25-49	Preset color
50-74	Red
75-99	Green
100-124	Yellow
125-149	Color switch between red and green
150-174	Color switch between green and yellow
175-199	Color switch between red and yellow
200-224	Color switch between red, green and yellow
225-255	Color rolling

Channel 4 – Strobe colors (CH3 must be set between 25-124)

0-24	stop
25-255	Strobe flash frequency, from slow to fast

Channel 4 – Color switch speed (CH3 must be set between 125-255)

0-24	stop
25-255	Color switch speed, from slow to fast

Channel 5 – Zoom

0-127	Zoom from 100% – 5%
128-169	Zoom In from 100% – 5% (slow to fast)
170-209	Zoom Out from 5% - 100% (slow to fast)
210-255	Zoom In and Out from slow to fast



Channel 6 – X-axis Moving

0-127	128 different fixed positions on X-axis
128-191	Clockwise moving from slow to fast
192-255	Counterclockwise moving from slow to fast



Channel 7 – Y-axis Moving

0-127	128 different fixed positions on Y-axis
128-191	Clockwise moving from slow to fast
192-255	Counterclockwise moving from slow to fast



Channel 8 – Y-axis Rolling

0-127	0-359 degree fixed Y-Axis rolling
128-191	Counterclockwise rolling from slow to fast
192-255	Clockwise rolling from slow to fast



Channel 9 – X-axis Rolling

0-127	0-359 degree fixed X-Axis rolling
128-191	Counterclockwise rolling from slow to fast
192-255	Clockwise rolling from slow to fast











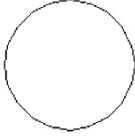
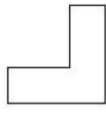

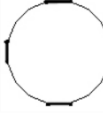

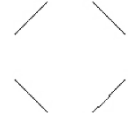

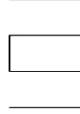
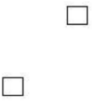



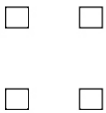



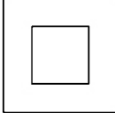

Channel 10 – Z-axis Rolling

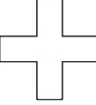
0-127	0-359 degree fixed Z-Axis rolling
128-191	Counterclockwise rolling from slow to fast
192-255	Clockwise rolling from slow to fast

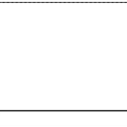

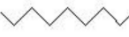
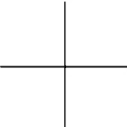
Patterns

DMX	PATTERNS	DMX	PATTERNS	DMX	PATTERNS	DMX	PATTERNS
000-007		064-071		128-135		190-197	
008-015		072-079		136-143		198-205	
016-023		080-087		144-151		206-213	
024-031		088-095		152-159		214-221	
032-039		096-103		160-167		222-229	
040-047		104-111		168-175		230-237	
048-055		112-119		176-181		238-245	
056-063		120-127		182-189		246-255	

Maintenance

The Showtec Galactic requires almost no maintenance. However, you should keep the unit clean. Otherwise, the fixture's light-output will be significantly reduced.

Disconnect the mains power supply and then wipe the cover with a damp cloth. Wipe the front glass panel clean with glass cleaner and a soft cloth. Do not use alcohol or solvents. The front glass panel will require weekly cleaning, as smoke-fluid tends to build up residues, reducing the light-output very quickly. Do not immerse in liquid.

Keep connections clean. Disconnect electric power, and then wipe the DMX and audio connections with a damp cloth. Make sure connections are thoroughly dry before linking equipment or supplying electric power.

The operator has to make sure that safety-relating and machine-technical installations are to be inspected by an expert after every year in the course of an acceptance test.

The operator has to make sure that safety-relating and machine-technical installations are to be inspected by a skilled person once a year.

The following points have to be considered during the inspection:

- 01) All screws used for installing the device or parts of the device have to be tightly connected and must not be corroded.
- 02) There may not be any deformations on housings, fixations and installation spots.
- 03) Mechanically moving parts like axles, eyes and others may not show any traces of wearing.
- 04) The electric power supply cables must not show any damages or material fatigue.

Replacing the Fuse

Power surges, short-circuit or inappropriate electrical power supply may cause a fuse to burn out. If the fuse burns out, the product will not function whatsoever. If this happens, follow the directions below.

- 01) Unplug the unit from electric power source.
- 02) Insert a screwdriver into the slot in the fuse cover. Gently pry up the fuse cover. The fuse will come out.
- 03) Remove the used fuse. If brown or unclear, it is burned out.
- 04) Insert the replacement fuse into the holder where the old fuse was. Reinsert the fuse cover. Be sure to use a fuse of the same type and specification. See the product specification label for details.

Troubleshooting

This troubleshooting guide is meant to help solve simple problems.

If a problem occurs, carry out the steps below in sequence until a solution is found. Once the unit operates properly, do not carry out following steps.

No Light

If the light effect does not operate properly, refer servicing to a technician.

Suspect three potential problem areas as: the power supply, the laser, the fuse.

- 01) Power supply. Check that the unit is plugged into an appropriate power supply.
- 02) The laser. Return the Galactic to your Showtec dealer.
- 03) The fuse. Replace the fuse. See page 23 for replacing the fuse.
- 04) If all of the above appears to be O.K., plug the unit in again.
- 05) If you are unable to determine the cause of the problem, do not open the Galactic, as this may damage the unit and the warranty will become void.
- 06) Return the device to your Showtec dealer.

No Response to DMX

Response: Suspect the DMX cable or connectors, a controller malfunction, a light effect DMX card malfunction.

- 01) Check the DMX setting. Make sure that DMX addresses are correct.
- 02) Check the DMX cable: Unplug the unit; change the DMX cable; then reconnect to electrical power. Try your DMX control again.
- 03) Determine whether the controller or light effect is at fault. Does the controller operate properly with other DMX products? If not, take the controller in for repair. If so, take the DMX cable and the light effect to a qualified technician.

Problem	Probable cause(s)	Remedy
One or more fixtures do not function at all	No power to the fixture	<ul style="list-style-type: none"> • Check that power is switched on and cables are plugged in
	Primary fuse blown	<ul style="list-style-type: none"> • Replace fuse
Fixtures reset correctly, but all respond erratically or not at all to the controller	The controller is not connected	<ul style="list-style-type: none"> • Connect controller
	3-pin XLR Out of the controller does not match XLR Out of the first fixture on the link (i.e. signal is reversed)	<ul style="list-style-type: none"> • Install a phase reversing cable between the controller and the first fixture on the link
Fixtures reset correctly, but some respond erratically or not at all to the controller	Poor data quality	<ul style="list-style-type: none"> • Check data quality. If much lower than 100 percent, the problem may be a bad data link connection, poor quality or broken cables, missing termination plug, or a defective fixture disturbing the link
	Bad data link connection	<ul style="list-style-type: none"> • Inspect connections and cables. Correct poor connections. Repair or replace damaged cables
	Data link not terminated with 120 Ohm termination plug	<ul style="list-style-type: none"> • Insert termination plug in output jack of the last fixture on the link
	Incorrect addressing of the fixtures	<ul style="list-style-type: none"> • Check address setting
	One of the fixtures is defective and disturbs data transmission on the link	<ul style="list-style-type: none"> • Bypass one fixture at a time until normal operation is regained: unplug both connectors and connect them directly together • Have the defective fixture serviced by a qualified technician
Shutter closes suddenly	3-pin XLR Out on the fixtures does not match (pins 2 and 3 reversed)	<ul style="list-style-type: none"> • Install a phase-reversing cable between the fixtures or swap pin 2 and 3 in the fixture, that behaves erratically
	The laser diode has lost its index position and the fixture is resetting the effect	<ul style="list-style-type: none"> • Contact a technician for servicing the problem persists
No light or laser cuts out intermittently	Fixture is too hot	<ul style="list-style-type: none"> • Allow fixture to cool • Make sure air vents at control panel and front lens are not blocked • Turn up the air conditioning
	Laser damaged	<ul style="list-style-type: none"> • Disconnect fixture and return to your dealer
	The power supply settings do not match local AC voltage and frequency	<ul style="list-style-type: none"> • Disconnect fixture. Check settings and correct if necessary

Product Specifications

Model:	Galactic RBP-180
Input Voltage:	100-240V AC, 50/60Hz
Continuous Power:	17W
Fuse:	T1A/250V
Dimensions:	145 x 160 x 155 mm (LxWxH) (incl. bracket)
Weight:	1,3 kg
Operation and Programming	
Signal pin OUT:	Pin 1 (earth), pin 2 (-), pin 3 (+)
DMX Channels:	8 channels
Signal input:	3-pin DMX IN
Signal output:	3-pin DMX OUT
Electro-mechanical effects	
Laser Class:	3B
Laser Power:	100mW (100mW 650nm Red) 80mW (80mW 450nm Blue)
Laser Color:	Red, Blue, Purple
Beam diameter:	<5mm at aperture
Pulse Data:	<4Hz (>0.25 sec)
Divergence (each beam):	<2 mrad;
Divergence (total light):	<90 degrees
Safety Features:	Key switch, Interlock
Laser Safety:	EN/IEC 60825-1 Ed 2, 2007-03
Scan Angle:	+30°
Scan speed:	stepping motor
On Board:	3-digit LED display for easy setup
Control Modes:	Auto, Master/Slave, Sound, DMX-512
Control protocol:	DMX-512
Cooling:	Fan/Convection
Housing:	Compact strong metal housing
Protection rate:	IP-20
Connections:	IEC connector (IN), 3-pin XLR (IN/OUT)
Max. ambient temperature t_a :	35°C
Minimum distance:	
Minimum distance from flammable surfaces:	0.5m
Minimum distance to lighted object:	1m

Design and product specifications are subject to change without prior notice.



Website: www.Showtec.info

Email: service@highlite.com

Dimensions

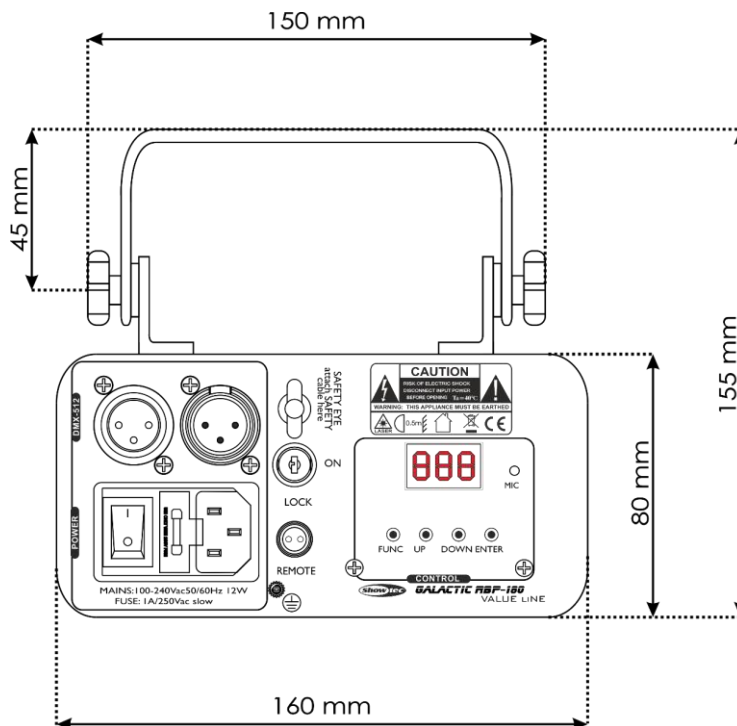
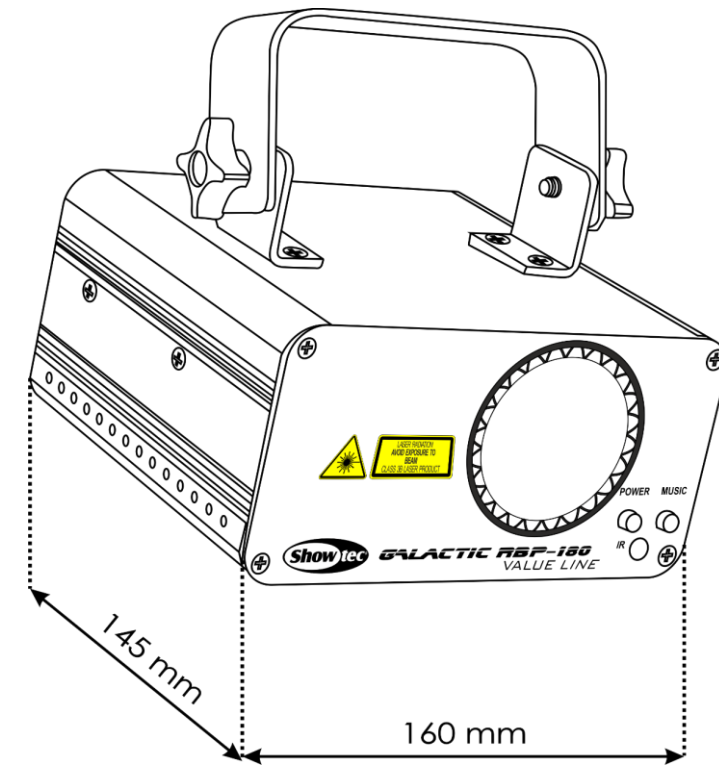



©2018 Showtec