

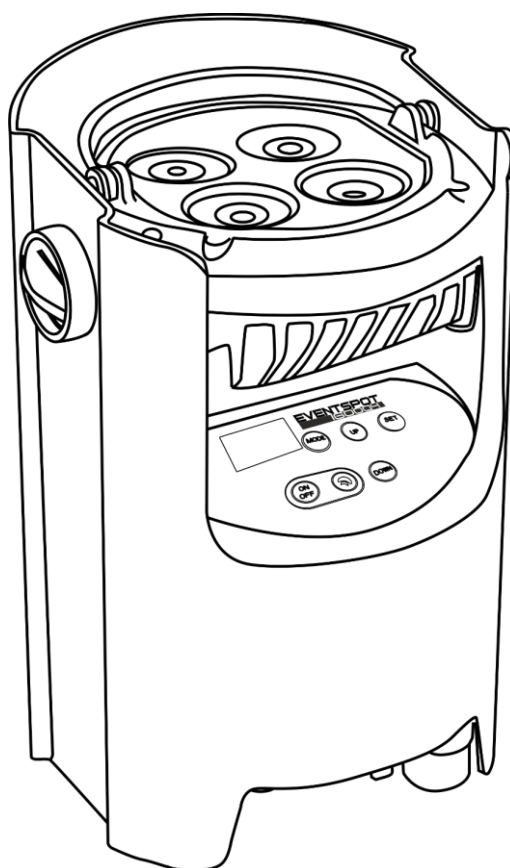

MANUAL



ENGLISH

EventSpot 1600 Q4 V1

Ordercode: 44050

Table of contents

Warning	3
Safety Instructions	3
Operating Determinations	5
Rigging	5
Connection with the mains	6
Return Procedure	7
Claims	7
Description of the device	8
Optional accessories	8
Overview	9
Bottom	9
Backside	10
Installation	10
Set Up and Operation	10
Charging the built-in battery	10
Control Modes	11
One EventSpot (Manual)	11
One EventSpot (Auto program)	11
One EventSpot (Built-in programs)	11
Multiple EventSpots (Master/Slave control)	12
Multiple EventSpots (DMX Control)	13
Multiple EventSpots (Wireless DMX Control)	14
Connect the EventSpot 1600 Q4 to the Wireless DMX signal transmitter	15
Disconnect from the Wireless DMX signal transmitter	15
Fixture Linking	16
Data Cabling	16
Control Panel	17
DMX Control Mode	17
DMX Addressing	17
Menu overview	18
Main Menu Options	19
1. DMX Address/ DMX Configuration/DMX signal	19
2. Manual	20
3. Auto program	20
4. Built-in programs	20
5. Master/slave	21
6. Settings	21
6.1. Curves Select	22
6.2. Dimmer Speed	22
6.3. DMX Fail	23
6.4. Working Time	23
6.5. DMX Sync	23
6.6. Lock	24
6.7. Calibration	24
6.8. Factory	24
7. Information	25
Optional remote control	25
Auto program	26
Built-in programs	26
Manual mode	26
DMX Channels	27
4 Channels	27
6 Channels	27
10 Channels	27

Maintenance29

Troubleshooting30

 No Light30

 No Response to DMX.....30

Product Specifications32

Dimensions.....33

Notes34

Warning



**For your own safety, please read this user manual carefully
before your initial start-up!**



Unpacking Instructions

Immediately upon receiving this product, carefully unpack the carton and check the contents to ensure that all parts are present, and have been received in good condition. Notify the dealer immediately and retain packing material for inspection if any parts appear to be damaged from shipping or the carton itself shows signs of mishandling. Save the carton and all packing materials. In the event that the fixture must be returned to the factory, it is important that the fixture be returned in the original factory box and packing.

Your shipment includes:

- EventSpot 1600 Q4
- User manual

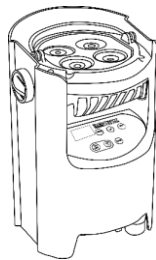

LED Expected Lifespan

LEDs gradually decline in brightness over time. HEAT is the dominant factor that leads to the acceleration of this decline. Packaged in clusters, LEDs exhibit higher operating temperatures than in ideal or singular optimum conditions. For this reason when all color LEDs are used at their fullest intensity, life of the LEDs is significantly reduced. If improving the lifespan is of higher priority, place care in providing for lower operational temperatures. This may include climatic-environmental and the reduction of overall projection intensity



CAUTION!

**Keep this device away from rain and moisture!
Unplug mains lead before opening the housing!**



Safety Instructions

Every person involved with the installation, operation and maintenance of this device has to:

- be qualified
- follow the instructions of this manual



**CAUTION! Be careful with your operations.
With a dangerous voltage you can suffer
a dangerous electric shock when touching the wires!**



Before your initial start-up, please make sure that there is no damage caused by transportation. Should there be any, consult your dealer and do not use the device.

To maintain perfect condition and to ensure a safe operation, it is absolutely necessary for the user to follow the safety instructions and warning notes written in this manual.

Please consider that damages caused by manual modifications to the device are not subject to warranty.

This device contains no user-serviceable parts. Refer servicing to qualified technicians only.

IMPORTANT:

The manufacturer will not accept liability for any resulting damages caused by the non-observance of this manual or any unauthorized modification to the device.

- Never remove warning or informative labels from the unit.
- Never use anything to cover the ground contact.
- Never place any material over the lens.
- Never look directly into the light source.
- Never leave any cables lying around.
- Do not insert objects into air vents.
- Do not connect this device to a dimmerpack.
- Do not switch the device on and off in short intervals, as this would reduce the device's lifespan.
- Do not touch the device's housing bare-handed during its operation. Allow the fixture to cool for at least 5 minutes before handling.
- Do not shake the device. Avoid brute force when installing or operating the device.
- Only operate the fixture after having checked that the housing is firmly closed and all screws are tightly fastened.
- Only operate the device after having familiarized with its functions.
- Avoid flames and do not put close to flammable liquids or gases.
- Always keep case closed while operating.
- Always allow free air space of at least 50 cm around the unit for ventilation.
- Make sure that the device is not exposed to extreme heat, moisture or dust.
- Make sure that the available voltage is not higher than stated on the rear panel.
- If the lens is obviously damaged, it has to be replaced to prevent its functions from being impaired, due to cracks or deep scratches.
- If device was dropped or struck, disconnect mains power supply immediately. Have a qualified engineer inspect for safety before operating.
- If the device has been exposed to drastic temperature fluctuation (e.g. after transportation), do not switch it on immediately. The arising condensation water might damage your device. Leave the device switched off until it has reached room temperature.
- If your Showtec device fails to work properly, discontinue use immediately. Pack the unit securely (preferably in the original packing material), and return it to your Showtec dealer for service.
- For adult use only. Device must be installed out of reach of children. Never leave the unit running unattended.
- Never attempt to bypass the thermostatic switch or fuses.
- For replacement, use fuses of same type and rating only.
- The user is responsible for correct positioning and operating of the Showtec EventSpot 1600 Q4. The manufacturer will not accept liability for damages caused by the misuse or incorrect installation of this device.
- This device falls under protection class I. Therefore it is essential to connect the yellow/green conductor to earth.
- Repairs, servicing and electrical connection must be carried out by a qualified technician.
- WARRANTY: Till one year after date of purchase.
- WARRANTY: on batteries is only 6 months after date of purchase.
When your battery remains dead after fully charging or it doesn't function or doesn't charge anymore, you can order a new battery. The spare part number for the battery is on request.



CAUTION! Eyedamages!!!
Avoid looking directly into the lightsource!!!
(meant especially for epileptics)!!!



Operating Determinations

- This device is not designed for permanent operation. Regular operation breaks will ensure that the device will serve you for a long time without defects.
- The minimum distance between light-output and the illuminated surface must be bigger than 0,5 meter.
- In order to eliminate wear and improve the device's lifespan, during periods of non-use, completely disconnect from power source via breaker or by unplugging.
- The maximum ambient temperature $t_a = 40^{\circ}\text{C}$ must never be exceeded.
- The relative humidity must not exceed 50 % with an ambient temperature of 40°C .
- If this device is operated in any other way than the one described in this manual, the product may suffer damages and the warranty becomes void.
- Any other operation may lead to dangers like short-circuit, burns, electric shock, crash etc.

You endanger your own safety and the safety of others!

Rigging

Please follow the European and national guidelines concerning rigging, trussing and all other safety issues.

Do not attempt the installation yourself!

Always let the installation be carried out by an authorized dealer!

Procedure:

- If the device is lowered from the ceiling or high joists, professional trussing systems have to be used.
- Use a clamp to mount the device, with the mounting-bracket, to the trussing system.
- The device must never be fixed swinging freely in the room.
- The installation must always be secured with a safety attachment, e.g. an appropriate safety net or safety cable.
- When rigging, derigging or servicing the device, always make sure, that the area below the installation place is blocked and staying in the area is forbidden.

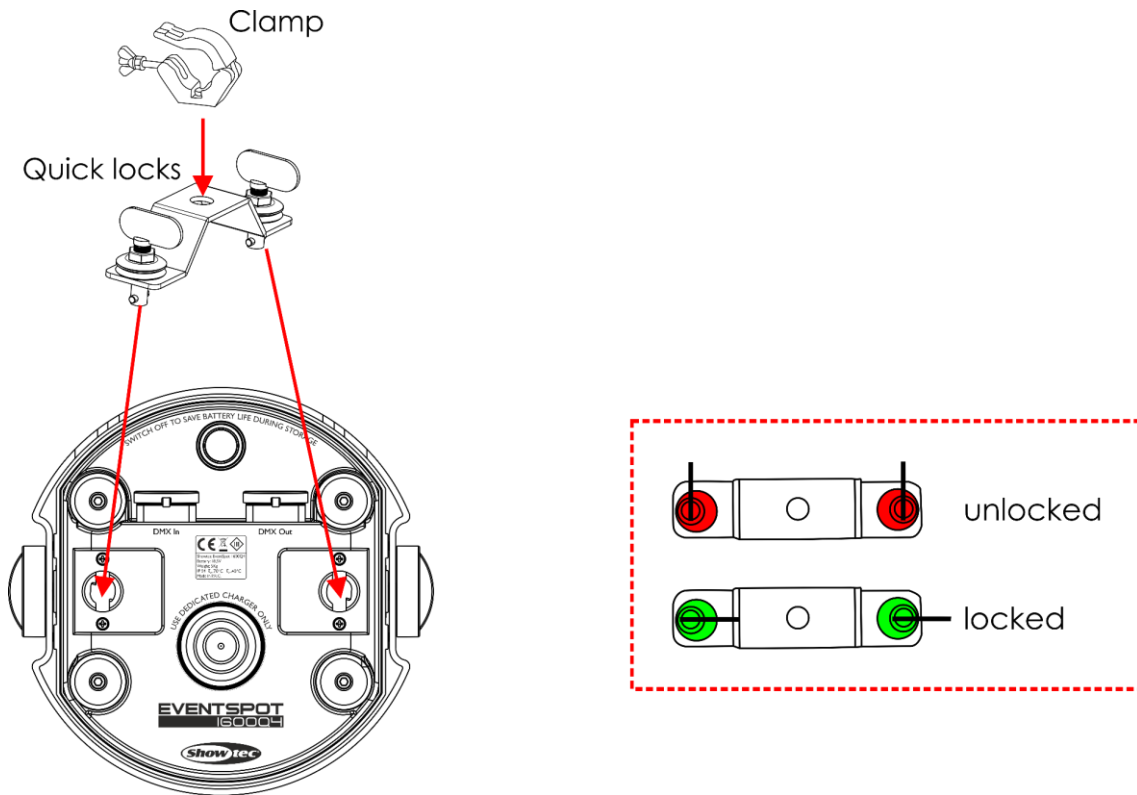

The EventSpot 1600 Q4 can be placed on a flat surface or fitted to any kind of truss with a clamp. Improper installation can cause serious damage to people and property!

Connection with the mains

Connect the device to the mains with the power plug. Always check if the right color cable is connected to the right place.

International	EU Cable	UK Cable	US Cable	Pin
L	BROWN	RED	YELLOW/COPPER	PHASE
N	BLUE	BLACK	SILVER	NEUTRAL
	YELLOW/GREEN	GREEN	GREEN	PROTECTIVE GROUND

Make sure that the device is always connected properly to the earth!

Improper installation can cause serious damage to people and property!





Return Procedure



Returned merchandise must be sent prepaid and in the original packing, call tags will not be issued. Package must be clearly labeled with a Return Authorization Number (RMA number). Products returned without an RMA number will be refused. Highlite will not accept the returned goods or any responsibility. Call Highlite 0031-455667723 or mail aftersales@highlite.com and request an RMA prior to shipping the fixture. Be prepared to provide the model number, serial number and a brief description of the cause of the return. Be sure to properly pack fixture as any shipping damage resulting from inadequate packaging is the customer's responsibility. Highlite reserves the right to use its own discretion to repair or replace product(s). As a suggestion, proper UPS packing or double-boxing is always a safe method to use.

Note: If you are given an RMA number, please include the following information on a piece of paper inside the box:

- 01) Your name.
- 02) Your address.
- 03) Your phone number.
- 04) A brief description of the symptoms.

Claims

The client has the obligation to check the delivered goods immediately upon delivery for any shortcomings and/or visible defects, or perform this check after our announcement that the goods are at their disposal. Damage incurred in shipping is the responsibility of the shipper; therefore the damage must be reported to the carrier upon receipt of merchandise.

It is the customer's responsibility to notify and submit claims with the shipper in the event that the fixture is damaged due to shipping. Transportation damage has to be reported to us within one day after receipt of the delivery.

Any return shipment has to be made post-paid at all times. Return shipments must be accompanied with a letter defining the reason for return shipment. Non-prepaid return shipments will be refused, unless agreed otherwise in writing.

Complaints against us must be made known in writing or by fax within 10 working days after receipt of the invoice. After this period, complaints will not be handled anymore.

Complaints will only be considered if the client has so far complied with all parts of the agreement, regardless of the agreement of which the obligation is resulting.

Description of the device

Features

The EventSpot 1600 Q4 is a wireless LED Eventspot from Showtec.

- Long battery life
- Eco mode for extended battery life
- IP-54 for outdoor use
- Wireless DMX by Wireless Solutions Sweden
- Input Voltage: 100~240V AC, 50/60Hz
- Battery storage: 15,6Ah
- Light source: 4 x 12W RGBW LEDs
- Drive current: 650mA
- Refresh rate: 12KHz
- Luminous flux: 1580
- Lux@2m: 15000
- Operating time at Full On: 8 hours at full RGBW on
- Charging time: 6 hours
- Battery type: Lithium ion
- Voltage: 18,5V
- Spare battery: On request
- OLED display for easy setup
- Control Protocol: DMX512 via wireless/ DMX512
- DMX channels: 4, 6 or 10 channels
- Control modes: Built-in programs, Auto, Manual, Master/Slave, DMX, W-DMX
- Beam angle: 10°
- Dimmer: 0-100%
- Strobe: 0-15Hz
- Housing: Black aluminum and iron
- IP rating: IP54
- Connections: Dedicated 3-pin XLR IN/OUT IP54
- Cooling: Aluminum heatsink
- Operation Temperature: -10°C ~40°C
- Dimensions: 180 x 180 x 280 mm (LxWxH)
- Weight: 5,0 Kg

Note: Knowledge of DMX is required to fully utilize this unit.

Optional accessories

[44002](#) – Showtec UR-5 Universal IR Remote

[44052](#) – Charger for EventSpot 1600 Q4

[44053](#) – Beamshaper for Eventspot 1600 Q4 (40°)

[44054](#) – Beamshaper for Eventspot 1600 Q4 (15° x 60°)

[44055](#) – Beamshaper for Eventspot 1600 Q4 (20°)

[50175](#) – W-DMX MicroBox F-1 G5 Transceiver

Overview

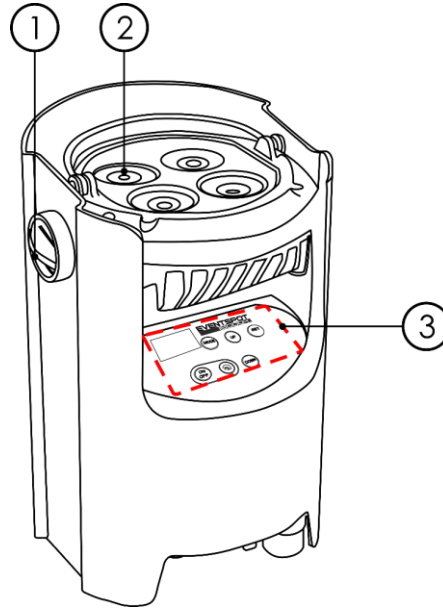

Fig. 01

- 01) Adjustment knob
- 02) 4 x 12W RGBW LEDs
- 03) OLED display + control buttons

Bottom

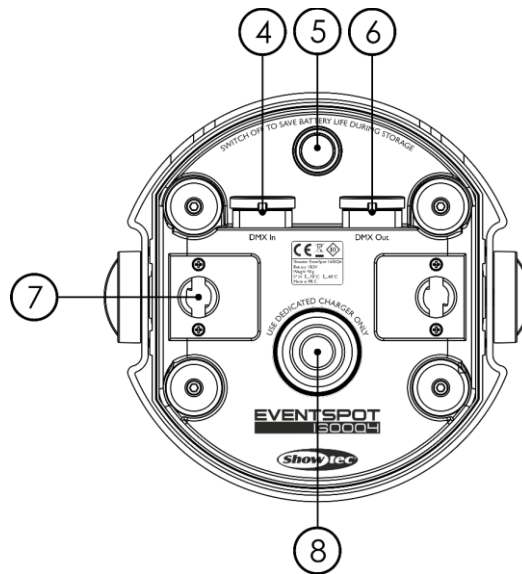

Fig. 02

- 04) Dedicated 3-pin DMX signal connector IN IP54
- 05) Main power button ON/OFF
- 06) Dedicated 3-pin DMX signal connector OUT IP54
- 07) Quick lock mounting hole
- 08) Battery charger socket

Backside

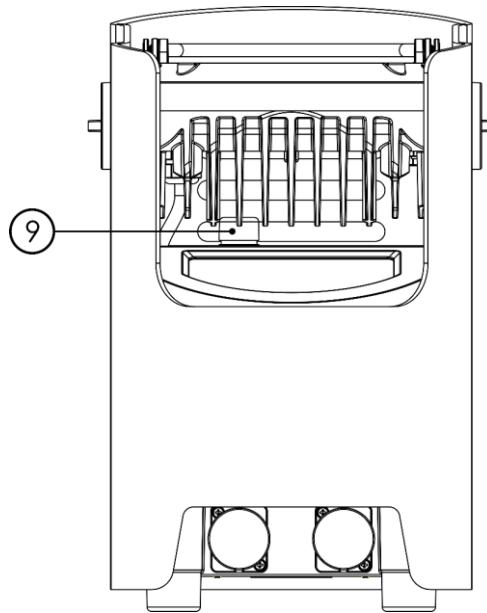

Fig. 03

09) Wireless DMX receiving antenna

Installation

Remove all packing materials from the EventSpot 1600 Q4. Check that all foam and plastic padding is removed. Connect all cables.

Do not supply power before the whole system is set up and connected properly.

Always disconnect from electric mains power supply before cleaning or servicing.

Damages caused by non-observance are not subject to warranty.

Set Up and Operation

Before plugging the unit in, always make sure that the power supply matches the product specification voltage. Do not attempt to operate a 120V specification product on 230V power, or vice versa.

Charging the built-in battery

- 01) In order to charge the battery you need the **optional** charger 44052 (is not included!).
- 02) Turn off the power.
- 03) Connect the EventSpot to the charger (fig 04).
- 04) Please make sure that the battery socket from the EventSpot covers the socket from the charger (fig 04).
- 05) Connect the charger to a powerCON to Schuko power cable.
- 06) Then plug the other end of the powerCON to Schuko power cable into a proper electric power supply socket.
- 07) Charge the battery within 6 hours.
- 08) The four LED indicators from the charger will light up green when the EventSpot is fully charged.

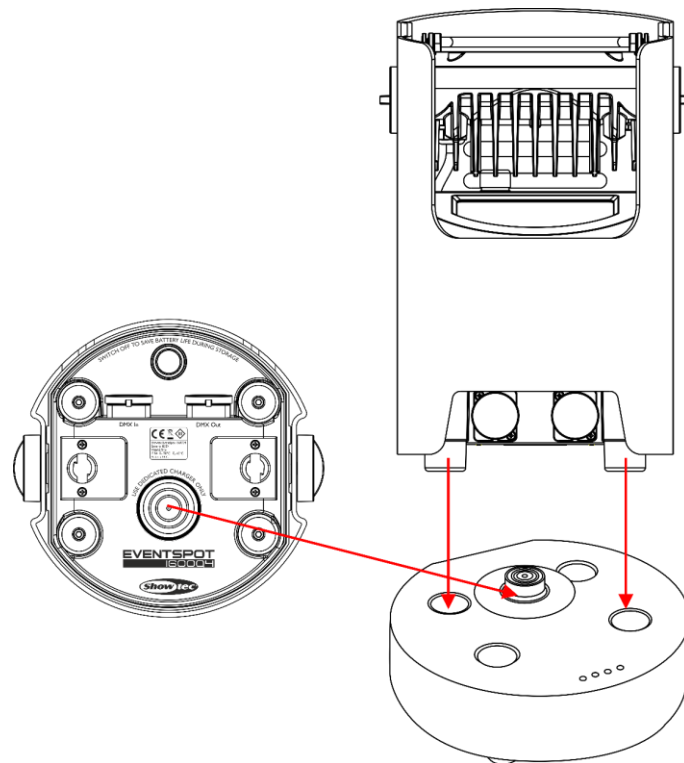

Fig. 04

Important!

- Do not charge for more than 24 hours.
- Recharge within 3 days of use.
- Press the **Main power** button (05) to off at the underside when storing for more than 7 days.
- Store in an upright position.

Control Modes

There are 6 modes:

- Manual (stand alone)
- Auto program (stand alone)
- Built-in programs (stand alone)
- Master/Slave
- DMX512
- Wireless DMX (W-DMX)

One EventSpot (Manual)

When the EventSpot is not connected by a DMX-cable and Wireless DMX is switched off, it functions as a stand-alone device. See page 20 for more information about the Manual mode.

One EventSpot (Auto program)

When the EventSpot is not connected by a DMX-cable and Wireless DMX is switched off, it functions as a stand-alone device. See page 20 for more information about the Auto program.

One EventSpot (Built-in programs)

When the EventSpot is not connected by a DMX-cable and Wireless DMX is switched off, it functions as a stand-alone device. See pages 20-21 for more information about the Built-in programs.

Multiple EventSpots (Master/Slave control)

01) Use a 3-p XLR cable to connect the EventSpots and other devices.

The pins:



1. Earth
2. Signal (-)
3. Signal (+)

02) Link the units as shown in (Fig. 05), connect a DMX signal cable from the first unit's DMX "out" socket to the second unit's "in" socket. Repeat this process to link the second, third and fourth units. You can use the same functions on the master device as described on pages 20-21 (Manual, Auto program or Built-in programs). This means you can set your desired operation mode on the master device and all slave devices will react the same as the master device.

Multiple EventSpots (Master/Slave control)

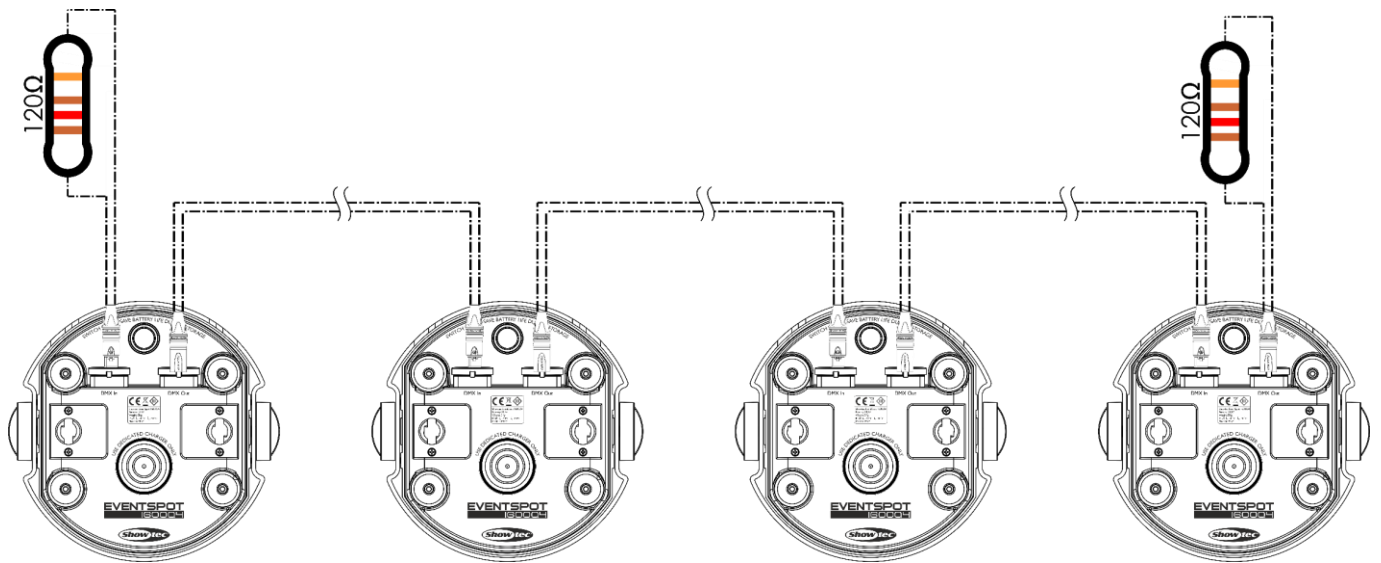
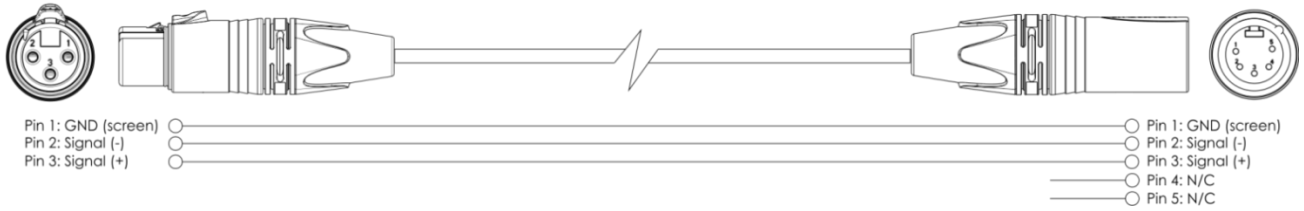
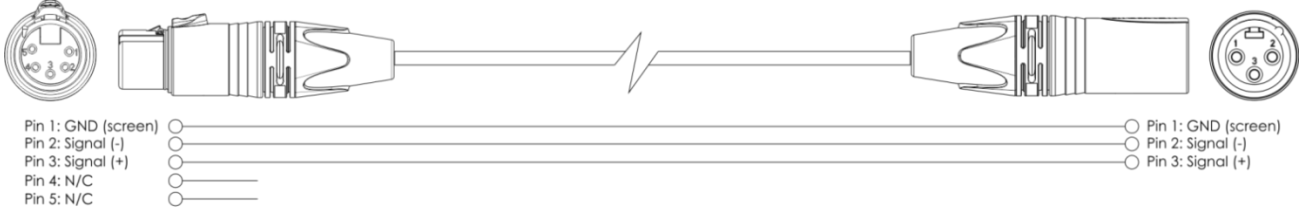

Fig. 05

Multiple EventSpots (DMX Control)

- 01) Leave at least 0,5 meter on all sides for air circulation
- 02) Use a 3-p XLR cable to connect the EventSpots and other devices.



- 03) Link the units as shown in (figure 06), connect a DMX signal cable from the first unit's DMX "out" socket to the second unit's "in" socket. Repeat this process to link the second, third and fourth units.

Multiple EventSpots DMX Set Up

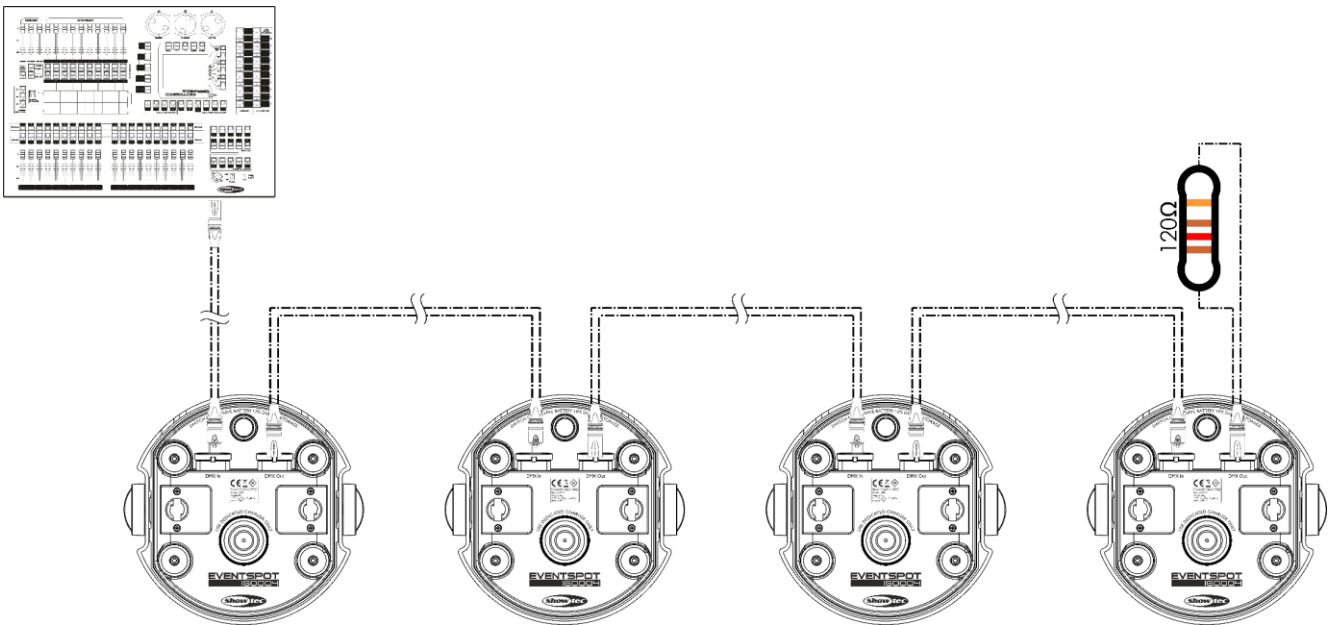

Fig. 06

Multiple EventSpots (Wireless DMX Control)

- 01) Place the EventSpots at the desired position (see page 15 for maximum WiFi distance).
- 02) When the W-DMX LED indicator (C) is blinking (green), the device is searching for a connection.
- 03) Connect the transmitter with multiple EventSpots. In order to create a Wireless match, please check the manual of your wireless signal transmitter.
- 04) When there is a connection, the W-DMX LED indicator (C) from the EventSpot will light up green.
- 05) Use a DMX-cable to link the transmitter with a suitable lightcontroller.

Setup example wireless DMX

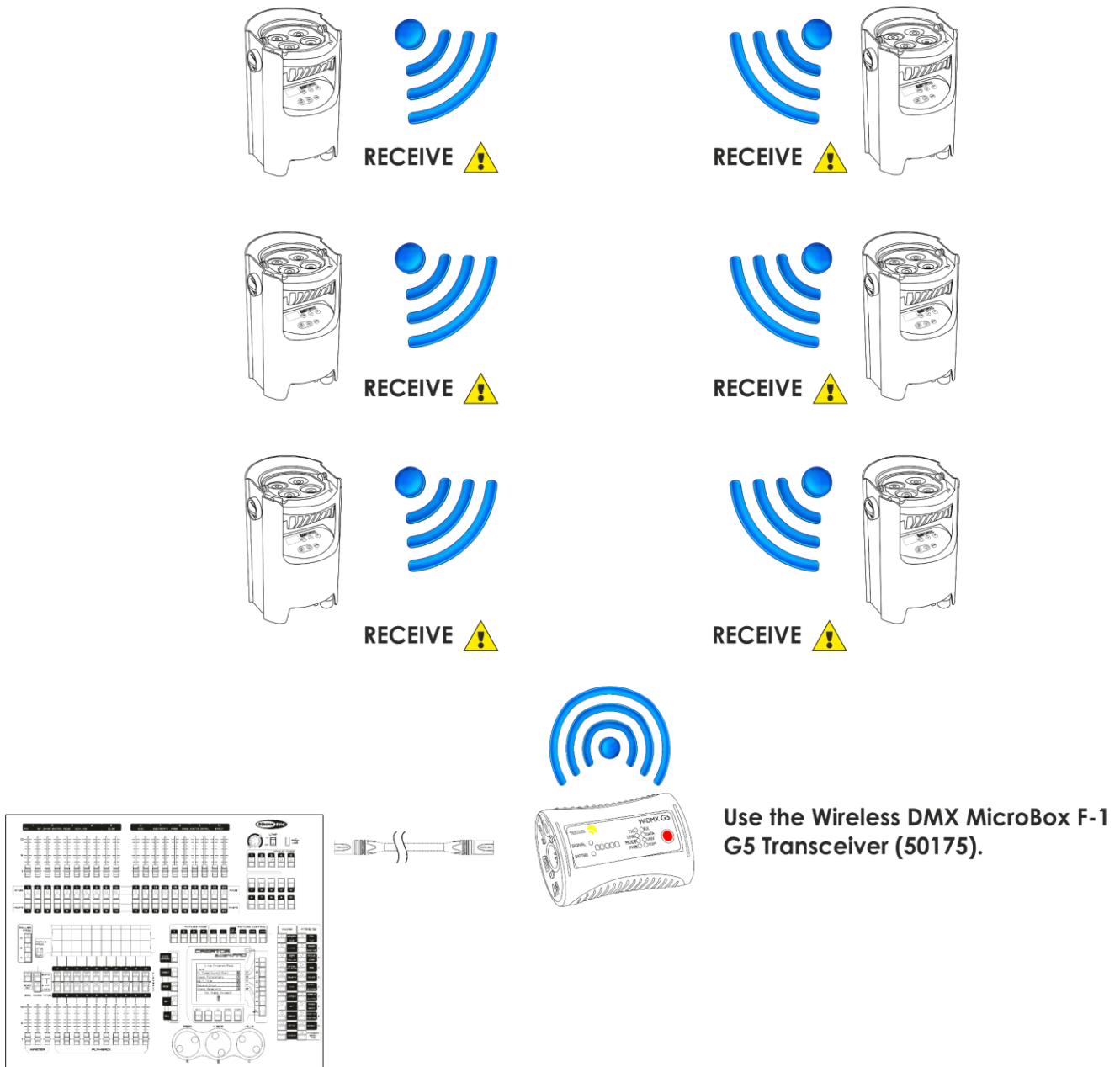

Fig. 07

Sweden 2.4GHz Wireless communication module

Communication distance:	Depending on the transmitting power or transmitter module
Test conditions:	W-DMX TRx Transmitter module, 2dBi Antenna, transmitting power 20dBm (100mW)
Range indoor:	60m (approx. through three concrete walls)
Range outdoor:	250m

Wireless DMX connection

The wireless receiving module "Pico G4 Receiver, 2.4GHz", provided by Swedish WIRELESS SOLUTION, only has a 2.4 GHz wireless signal receiving function. In order to match the wireless signal, please use the 50175 W-DMX MicroBox F-1 G5 Transceiver by WIRELESS SOLUTION. To control the status of the wireless communication, please look at the green LED indicator on the control panel of the fixture.

Wi-fi Problems:

- 01) No emitter/sender matching.
The LED Indicator dims for a long period of time.
- 02) Matching signal with one emitter, but loss of signal communication.
The LED Indicator light will light up for 100ms and then dim for 100ms; The LED will flicker quickly.
- 03) Communication with an emitter, but no DMX data.
The LED Indicator will light up for 900ms and then dim for 100ms; The LED will flicker slowly.

When the wireless DMX communication is normal, the LED indicator will always be on.



The EventSpot 1600 Q4 cannot receive a wireless DMX signal and a DMX cable signal at the same time



When the device is in manual, auto program or built-in program, please ensure that the matching 2.4GHz wireless signal transmitter is OFF.

Connect the EventSpot 1600 Q4 to the Wireless DMX signal transmitter

The EventSpot 1600 Q4 cannot actively match a random wireless signal transmitter. In order to create a Wireless match, please check the manual of your wireless signal transmitter. We advise you to use the W-DMX MicroBox F-1 G5 Transceiver (50175) by WIRELESS SOLUTION (Fig. 08).

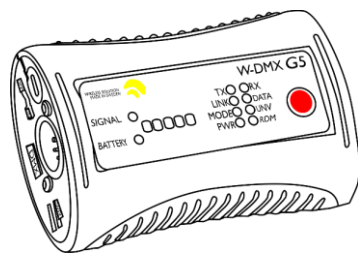

Ordercode: 50175

Fig. 08

Disconnect from the Wireless DMX signal transmitter

The EventSpot 1600 Q4 can be disconnected from the wireless DMX signal transmitter. You can turn off/unlink the W-DMX if you press the W-DMX button (H) for 3 seconds. The EventSpot will be disconnected.

Fixture Linking

You will need a serial data link to run light shows of one or more fixtures using a DMX-512 controller or to run synchronized shows on two or more fixtures set to a master/slave operating mode. The combined number of channels required by all the fixtures on a serial data link determines the number of fixtures the data link can support.

Important: Fixtures on a serial data link must be daisy chained in one single line. To comply with the EIA-485 standard no more than 30 devices should be connected on one data link. Connecting more than 30 fixtures on one serial data link without the use of a DMX optically isolated splitter may result in deterioration of the digital DMX signal.
Maximum recommended DMX data link distance: 100 meters
Maximum recommended number of EventSpots on a DMX data link: 30 fixtures



Data Cabling

To link fixtures together you must obtain data cables. You can purchase DAP Audio certified DMX cables directly from a dealer/distributor or construct your own cable. If you choose to create your own cable please use data-grade cables that can carry a high quality signal and are less prone to electromagnetic interference.

DAP Audio DMX Data Cables

- DAP Audio Basic microphone cable for allround use. bal. XLR/M 3-pin > XLR/F 3-pin. **Ordercode** FL01150 (1,5 m), FL013 (3 m), FL016 (6 m), FL0110 (10 m), FL0115 (15 m), FL0120 (20 m).
- DAP Audio X-type data cable XLR/M 3-pin > XLR/F 3-pin. **Ordercode** FLX0175 (0,75 m), FLX01150 (1,5 m), FLX013 (3 m), FLX016 (6 m), FLX0110 (10 m).
- DAP Audio cable for the demanding user with exceptional audio-qualities and connector made by Neutrik®. **Ordercode** FL71150 (1,5 m), FL713 (3 m), FL716 (6 m), FL7110 (10 m).
- DAP Audio cable for the demanding user with exceptional audio-qualities and connector made by Neutrik®. **Ordercode** FL7275 (0,75 m), FL72150 (1,5 m), FL723 (3 m), FL726 (6 m), FL7210 (10 m).
- DAP Audio 110 Ohm cable with digital signal transmission. **Ordercode** FL0975 (0,75 m), FL09150 (1,5 m), FL093 (3 m), FL096 (6 m), FL0910 (10 m), FL0915 (15 m), FL0920 (20 m).
- DAP Audio data cable FL08 DMX/AES-EBU, XLR/M 5-pin > XLR/F 5-pin. **Ordercode** FL08150 (1,5 m), FL083 (3 m), FL086 (6 m), FL0810 (10 m), FL0820 (20 m).
- DAP Audio DMX adapter: 5-pin > 3-pin. **Ordercode** FLA29.
- DAP Audio DMX adapter: 3-pin > 5-pin. **Ordercode** FLA30.
- DAP Audio DMX Terminator 3-pin. **Ordercode** FLA42.
- DAP Audio DMX Terminator 5-pin. **Ordercode** FLA43.

The EventSpot 1600 Q4 can be operated with a controller in **control mode** or without the controller in **stand-alone mode**.

Control Panel

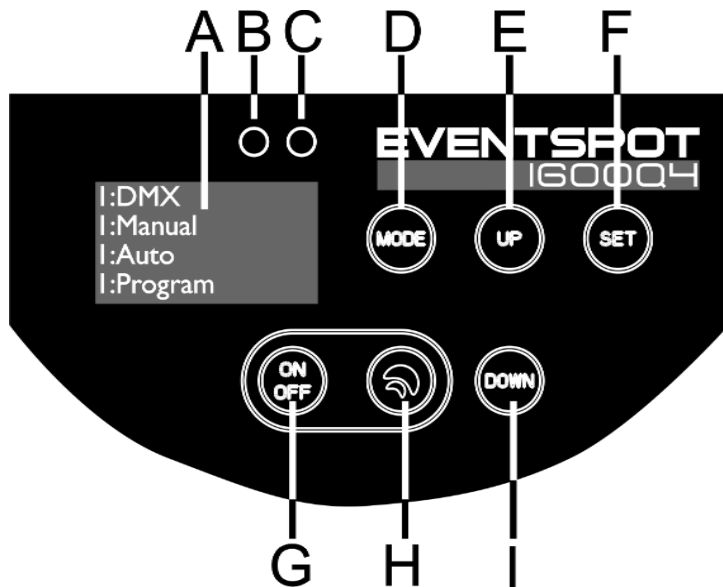

- A) OLED display
- B) IR-remote sensor
- C) W-DMX LED indicator
- D) MODE button
- E) UP button
- F) SET button
- G) Power button on/off
- H) W-DMX button
- I) DOWN button

Fig.09

DMX Control Mode

The fixtures are individually addressed on a data-link and connected to the controller. The fixtures respond to the DMX signal from the controller. (When you select the DMX address and save it, the controller will display the saved DMX address, next time.)

DMX Addressing

The control panel on the back side of the device allows you to assign the DMX fixture address, which is the first channel from which the EventSpot will respond to the controller. Please note when you use the controller, the unit has up to **10** channels. When using multiple EventSpots, make sure you set the DMX addresses right. Therefore, the DMX address of the first EventSpot should be **1(001)**; the DMX address of the second EventSpot should be **1+10=11 (011)**; the DMX address of the third EventSpot should be **11+10=21 (021)**, etc. Please, be sure that you don't have any overlapping channels in order to control each EventSpot correctly. If two or more EventSpots are addressed similarly, they will work similarly.

Controlling: After having addressed all EventSpots, you may now start operating these via your lighting controller.

Note: After switching on, the EventSpot will automatically detect whether DMX 512 data is received or not. If there is no data received at the DMX-input, the problem may be:

- The XLR cable from the controller is not connected with the input of the EventSpot.
- The controller is switched off or defective, the cable or connector is defective, or the signal wires are swapped in the input connector.

Note: It's necessary to insert a XLR termination plug (with 120 Ohm) in the last fixture in order to ensure proper transmission on the DMX data link.

⚠ Display Off after 60 seconds ⚠

When no button is pressed for 60 seconds, the display will turn off. To light up the display, you have to press the MODE, SET, UP or DOWN button. Once you have pressed the button, the display will light up.

Menu overview

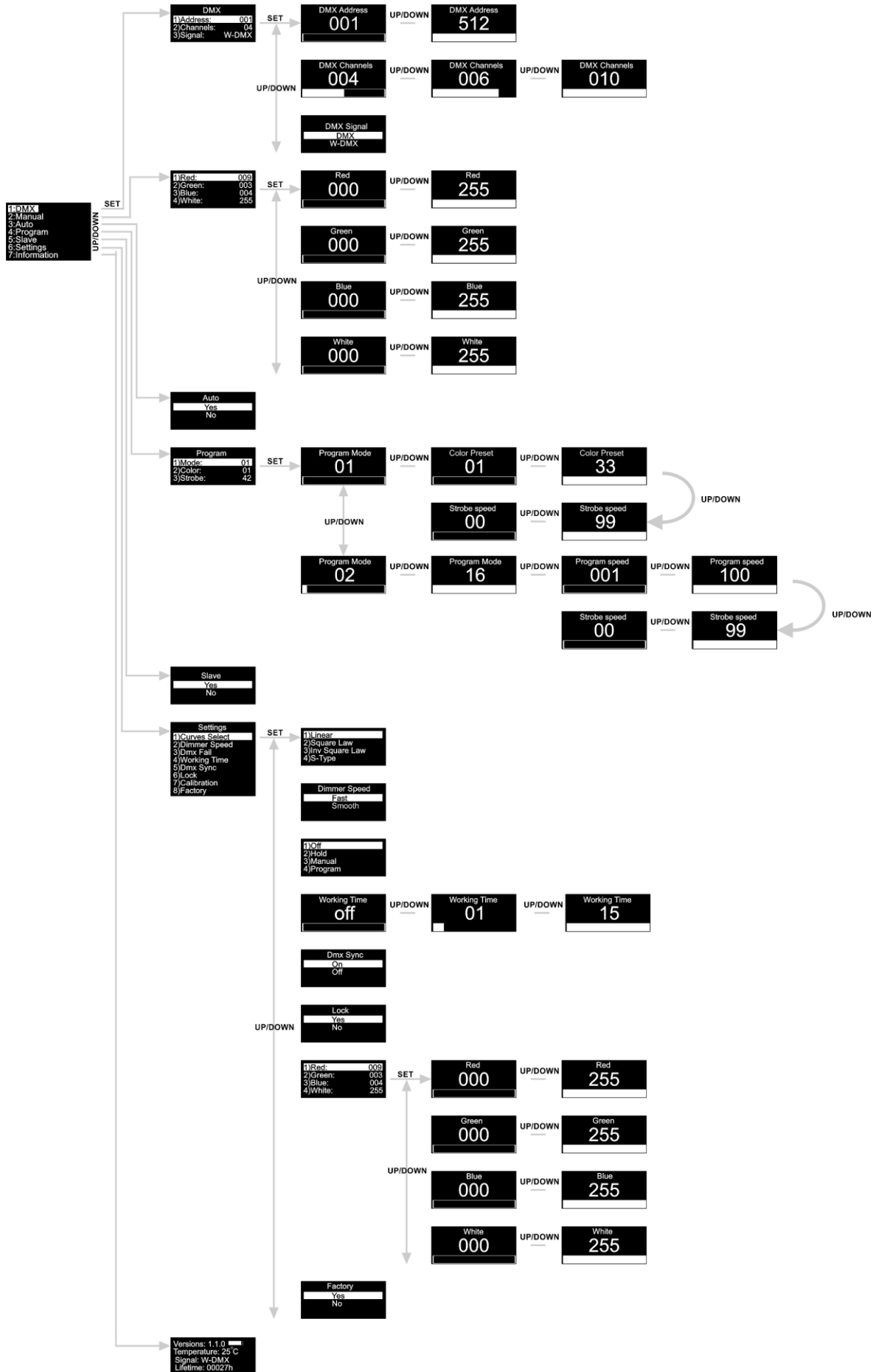

First press the main power button (5) and then hold the power button (G) for at least 3 sec. to activate the EventSpot! The EventSpot will show the current software version, battery energy level, actual temperature and type of DMX signal at start-up !



Versions: 1.1.0
Temperature: 25°C
Signal: W-DMX

Main Menu Options

- 01) Press the **MODE** or **SET** button to open the main menu.
- 02) Press the **UP/DOWN** buttons to scroll through the menu. The display will show:

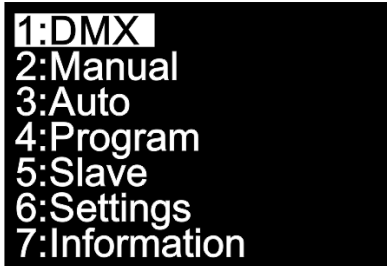

- 03) Press the **SET** button to open the desired menu.
- 04) Press the **MODE** button to return to the previous menu.

1. DMX Address/ DMX Configuration/DMX signal

In this menu you can set the device's DMX starting address, choose a DMX channel mode or choose between the DMX signal options.

- 01) While in main menu, press the **UP/DOWN** buttons until the display shows **DMX**.
- 02) Press the **SET** button to open the menu, the display will show:

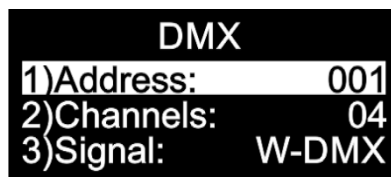

- 03) Press the **UP/DOWN** buttons to set the DMX address, the desired configuration and activate DMX or W-DMX mode.

- 04) If you choose the DMX address , press the **SET** button to open the submenu.
- 05) Press the **UP/DOWN** buttons to set the desired address. The adjustment range is between



- 06) If you choose the DMX configuration , press the **SET** button to open the submenu.
- 07) Press the **UP/DOWN** buttons to choose between:

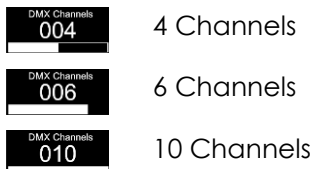

- 08) If you choose Signal, press the **SET** button to open the submenu:



- 09) Press the **UP/DOWN** buttons to select normal DMX or wireless DMX mode.
- 10) Press the **SET** button to confirm your choice.

2. Manual

In this menu you can individually set the static colors.

- 01) While in main menu, press the **UP/DOWN** buttons until the display shows **Manual**.
- 02) Press the **SET** button to open the menu, the display will show:

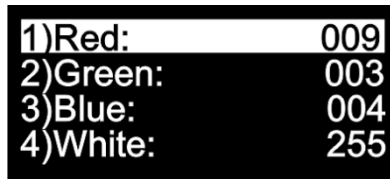

- 03) Press the **UP/DOWN** buttons to scroll between the static colors Red, Green, Blue and White.
- 04) If you choose the desired color, press the **SET** button to adjust the color intensity.
- 05) Press the **UP/DOWN** buttons to set the intensity from the desired colors, the adjustment ranges are between:

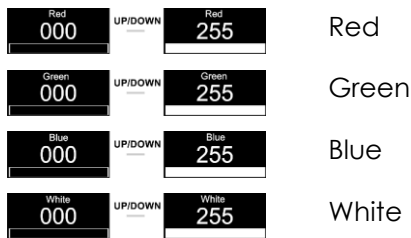

3. Auto program

In this menu you can activate the Auto program.

- 01) While in main menu, press the **UP/DOWN** buttons until the display shows **Auto**.
- 02) Press the **SET** button to open the menu, the display will show:

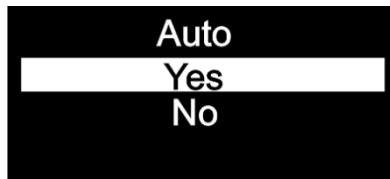

- 03) Press the **UP/DOWN** buttons to choose between **Yes** or **No**.
- 04) If you choose **Yes**, the EventSpot will immediately start the Auto program.
- 05) If you choose **No**, the EventSpot doesn't start the Auto program and the output will blackout.
- 06) Press the **SET** button to confirm your choice.





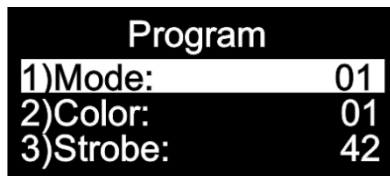

4. Built-in programs

In this menu you can set the built-in programs.

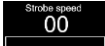
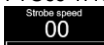
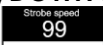
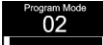
- 01) While in main menu, press the **UP/DOWN** buttons until the display shows **Program**.
- 02) Press the **SET** button to open the menu, the display will show:

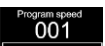

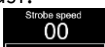
- 03) Press the **SET** button to open the menu and use the **UP/DOWN** buttons to choose between the built-in programs. The adjustment range is between **01** and **16**.
- 04) If you choose **01**, press the **UP/DOWN** buttons to choose the desired color or set the strobe frequency.
- 05) If you choose the color **01**, press the **SET** button to open the submenu.
- 06) Press the **UP/DOWN** buttons to choose one of the 33 available preset colors **01** to **33**.

- 07) If you choose the strobe frequency , press the **SET** button to open the submenu.
- 08) Press the **UP/DOWN** buttons to set the desired strobe frequency. The adjustment range is between  **UP/DOWN** , from OFF to high strobe frequency.
- 09) If you choose  **UP/DOWN** , press the **UP/DOWN** buttons to set the program speed and strobe frequency.
- 10) If you choose the program speed , press the **SET** button to open the submenu.
- 11) Press the **UP/DOWN** buttons to set the desired program speed. The adjustment range is between  **UP/DOWN** , from slow to fast.
- 12) If you choose the strobe frequency , press the **SET** button to open the submenu.
- 13) Press the **UP/DOWN** buttons to set the desired strobe frequency. The adjustment range is between  **UP/DOWN** , from OFF to high strobe frequency.

5. Master/slave

In this menu you can set the device as a slave.

- 01) While in main menu, press the **UP/DOWN** buttons until the display shows **Slave**.
- 02) Press the **SET** button to open the menu, the display will show:

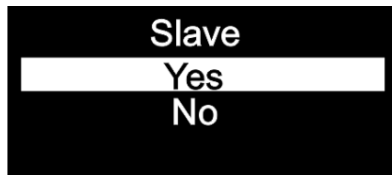

- 03) If you choose **Yes**, the device will become a slave.
- 04) All slave devices will follow the master movement. If the device has been set to slave, it will react the same as its master device.
- 05) If you choose **No**, it is automatically classified as a master device.
- 06) Press the **SET** button to confirm your choice.

6. Settings

In this menu you can set several settings of the device.

- 01) While in main menu, press the **UP/DOWN** buttons until the display shows **Settings**.
- 02) Press the **SET** button to open the menu, the display will show:

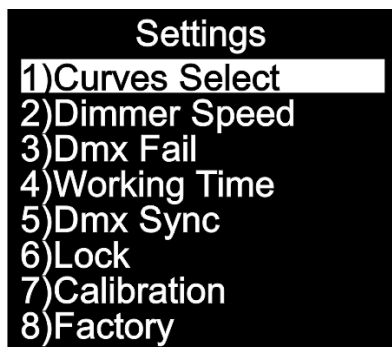

- 03) Press the **UP/DOWN** buttons to scroll between the following menus: Curves Select, Dimmer Speed, DMX Fail, Working Time, DMX Sync, Lock, Calibration and Factory.

6.1. Curves Select

In this menu you can adjust the dimming of the device by choosing a dimming curve.

- 01) Press the **UP/DOWN** buttons until the display shows **Curves Select**.
- 02) Press the **SET** button to open the menu, the display will show:

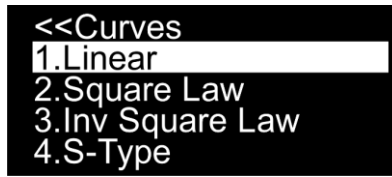

- 03) Press the **UP/DOWN** buttons to choose the desired dimming curve out of the 4 available options:

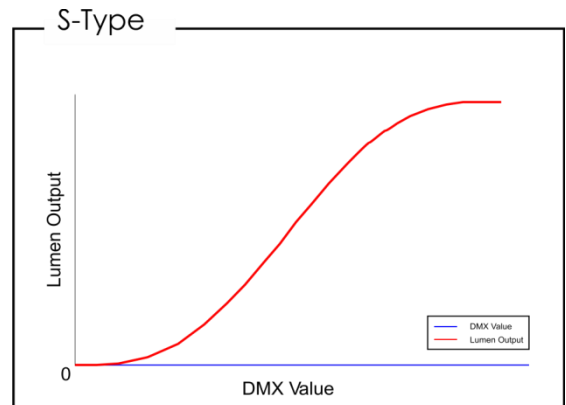
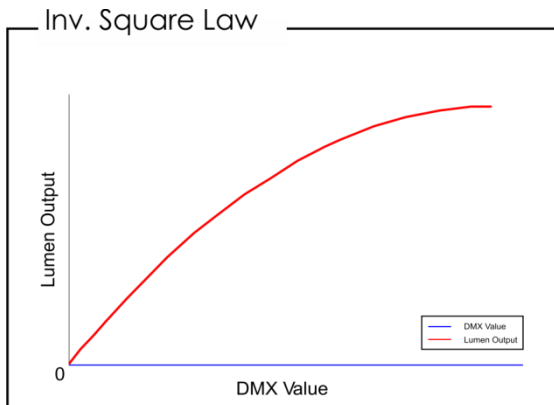
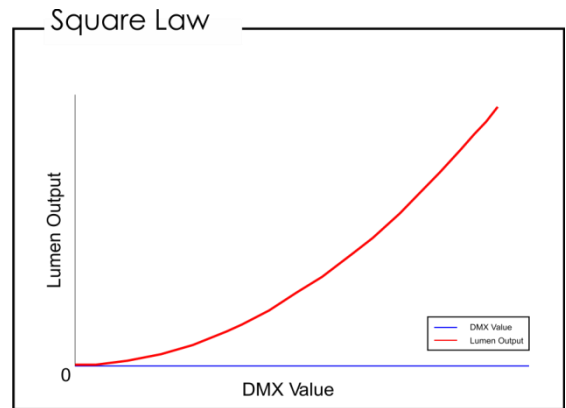
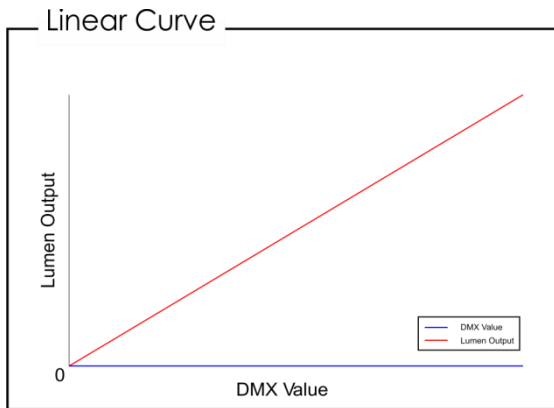

- 04) Press the **SET** button to confirm your choice.

6.2. Dimmer Speed

In this menu you can adjust the dimming speed of the device.

- 01) Press the **UP/DOWN** buttons until the display shows **Dimmer Speed**.
- 02) Press the **SET** button to open the menu, the display will show:



- 03) Press the **UP/DOWN** buttons to choose between **Fast** or **Smooth**.
- 04) Press the **SET** button to confirm your choice.

6.3. DMX Fail

In this menu you can adjust the behaviour of the device in case of a DMX signal error.

- 01) Press the **UP/DOWN** buttons until the display shows **Dmx Fail**.
- 02) Press the **SET** button to open the menu, the display will show:

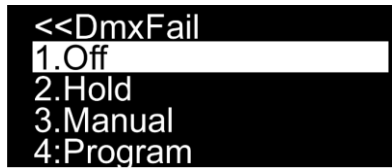



- 03) Press the **UP/DOWN** buttons to choose between the 4 options.
- 04) If you choose **Off**, the output will blackout when a DMX signal error occurs.
- 05) If you choose **Hold**, the device will fall back on the last properly working DMX signal from before the DMX signal error, which ensures uninterrupted performance.
- 06) If you choose **Manual**, the device will fall back on the last setting in the Manual mode before the DMX signal error.
- 07) If you choose **Program**, the device will fall back on the last setting in the Program mode before the DMX signal error.
- 08) Press the **SET** button to confirm your choice.

6.4. Working Time

In this menu you can increase the operating time of the battery.

- 01) Press the **UP/DOWN** buttons until the display shows **Working Time**.
- 02) Press the **SET** button to open the menu, the display will show:

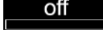
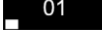

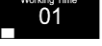
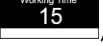
- 03) Press the **UP/DOWN** buttons to choose between  or  **UP/DOWN** .
- 04) If you choose , the EventSpot 1600 Q4 will have maximum output, this is the normal mode.
- 05) If you choose  **UP/DOWN** , you can set the working time from 1-15, the output will reduce but the operating time will increase to a maximum of 15Hr.
- 06) Press the **SET** button to confirm your choice.

6.5. DMX Sync

In this menu you can set the DMX synchronisation of the device.

- 01) Press the **UP/DOWN** buttons until the display shows **Dmx Sync**.
- 02) Press the **SET** button to open the menu, the display will show:

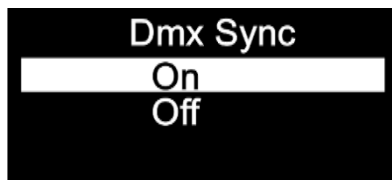

- 03) Press the **UP/DOWN** buttons to select **On** or **Off**.
- 04) The Sync option is a tool which helps to keep multiple fixtures synchronized, when using them in master slave mode.
- 05) If you choose **On**, the synchronization function is activated, this is recommended.
- 06) If you choose **Off**, the synchronization function is not activated.
- 07) Press the **SET** button to confirm your choice.

6.6. Lock

In this menu you can select whether the safety lock is active or not.

- 01) Press the **UP/DOWN** buttons until the display shows **Lock**.
- 02) Press the **SET** button to open the menu, the display will show:

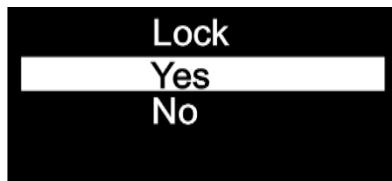

- 03) Press the **UP/DOWN** buttons to select **Yes** or **No**.
- 04) If you choose **Yes** and confirm it with the **SET** button, the device will be in Lock mode. You will need to insert the password in order to access the main menu. Simultaneously press the **MODE** and **SET** button for 3 seconds and you will be able to access the main menu.
- 05) If you choose **No**, the main menu will remain unlocked.
- 06) Press the **SET** button to confirm your choice.

6.7. Calibration

In this menu you can set the white color calibration.

- 01) Press the **UP/DOWN** buttons until the display shows **Calibration**.
- 02) Press the **SET** button to open the menu, the display will show:

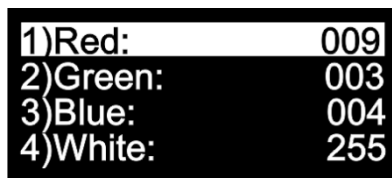

- 03) Press the **UP/DOWN** buttons to scroll between the static colors Red, Green, Blue and White.
- 04) If you choose the desired color, press the **SET** button to adjust the color intensity.
- 05) Press the **UP/DOWN** buttons to set the intensity from the desired colors, the adjustment ranges are between:

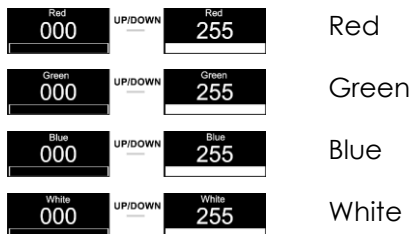

6.8. Factory

In this menu you can reset to the default settings.

- 01) Press the **UP/DOWN** buttons until the display shows **Factory**.
- 02) Press the **SET** button to open the menu, the display will show:

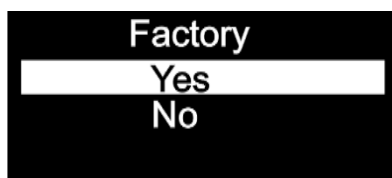

- 03) Press the **UP/DOWN** buttons to select **Yes** or **No**.
- 04) If you choose **Yes** and confirm it with the **SET** button, the device will reset to its factory default settings.
- 05) If you choose **No**, the device will keep current settings.

7. Information

In this menu you can view several info from the device.

- 01) In main menu, press the **UP/DOWN** buttons until the display shows **Information**.
- 02) Press the **SET** button to open the menu, the display will show:

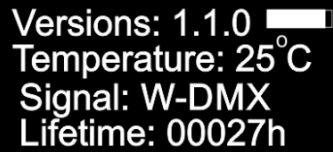







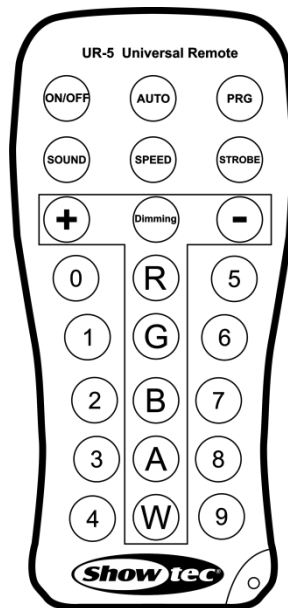



Versions: 1.1.0
Temperature: 25°C
Signal: W-DMX
Lifetime: 00027h

- 03) You can view the currently installed software version, actual temperature, type of DMX signal and life time.

Optional remote control



Button	Function	Description
	On / Off	Switch the device ON or OFF
	Auto	Activates the Auto program
	Program	Activates the Built-in programs
	No function	
	Speed	Activates the Program speed mode
	Strobe	Activates the Strobe frequency mode
	Dimming	Activates the Manual Color mode
	Plus	Increase button
	Minus	Decrease button
	Red	Activates the Red color
	Green	Activates the Green color

B	Blue	Activates the Blue color
A	No function	
W	White	Activates the White color
0	Green	Activates the Green color
1	Purple	Activates the Purple color
2	Purplish red	Activates the Purplish red color
3	Orange	Activates the Orange color
4	White	Activates the White color
5	Bright pink	Activates the Bright pink color
6	Light green	Activates the Light green color
7	Water blue	Activates the Water blue color
8	Yellow	Activates the Yellow color
9	Warm white	Activates the Warm white color

Auto program

- 01) Press the **AUTO** button to activate Auto program.
- 02) The EventSpot 1600 Q4 will immediately start with its built-in program.

Built-in programs

- 01) Press the **PRG** button to activate the Built-in programs mode.
- 02) Press the **+** and **-** buttons to choose between program 01-16.
- 03) If you choose program 01, you can set the desired color preset with the buttons **0** - **9**.
- 04) Press the **STROBE** button to set the strobe frequency of the preset colors.
- 05) Press the **+** and **-** buttons to increase/decrease the strobe frequency. The adjustment range is between 0-15Hz, from OFF to high strobe frequency.
- 06) If you choose program 02-16, you can set the program speed and strobe frequency.
- 07) Press the **SPEED** button to set the program speed.
- 08) Press the **+** and **-** buttons to to increase/decrease the program speed. The adjustment range is between 01-100, from slow to fast.
- 09) Press the **STROBE** button to set the strobe frequency.
- 10) Press the **+** and **-** buttons to increase/decrease the strobe frequency. The adjustment range is between 0-15Hz, from OFF to high strobe frequency.

Manual mode

- 01) Press the **Dimming** button to activate the manual mode.
- 02) Press the **R**, **G**, **B** or **W** button to choose one of the RGBW colors.
- 03) Press the **+** and **-** buttons to set the intensity of the individual colors between 0-255.
- 04) In this mode you can create your desired color.

DMX Channels

4 Channels

Channel 1 – Red Dimmer intensity

0-255 Gradual adjustment Red from 0-100%

Channel 2 – Green Dimmer intensity

0-255 Gradual adjustment Green from 0-100%

Channel 3 – Blue Dimmer intensity

0-255 Gradual adjustment Blue from 0-100%

Channel 4 – White Dimmer intensity

0-255 Gradual adjustment White from 0-100%

6 Channels

Channel 1 – Master Dimmer intensity

0-255 Gradual adjustment, from dark to brightest 0-100%

Channel 2 – Strobe (CH1 and CH3, CH4, CH5 or CH6 must be set between 1-255 )

0-10 Closed

11-128 Random strobe, from slow to fast

129-255 Strobe flash frequency, from low to high frequency (0-15 Hz)

Channel 3 – Red Dimmer intensity (CH1 must be set between 1-255 )

0-255 Gradual adjustment Red from 0-100%

Channel 4 – Green Dimmer intensity (CH1 must be set between 1-255 )

0-255 Gradual adjustment Green from 0-100%

Channel 5 – Blue Dimmer intensity (CH1 must be set between 1-255 )

0-255 Gradual adjustment Blue from 0-100%

Channel 6 – White Dimmer intensity (CH1 must be set between 1-255 )

0-255 Gradual adjustment White from 0-100%

10 Channels

Channel 1 – Master Dimmer intensity

0-255 Gradual adjustment, from dark to brightest 0-100%

Channel 2 – Strobe (CH1 and CH3, CH4, CH7, CH8, CH9 or CH10 must be set between 1-255 )

0-10 Closed

11-128 Random strobe, from slow to fast

129-255 Strobe flash frequency, from low to high frequency (0-15 Hz)

Channel 3 – Color presets (CH1 must be set between 1-255 )

0-7	No function
8-13	Color 1 (R255, G000, B000, W000)
14-20	Color 2 (R255, G000, B000, W100)
21-27	Color 3 (R255, G000, B000, W200)
28-34	Color 4 (R255, G050, B000, W000)
35-41	Color 5 (R255, G150, B000, W000)
42-48	Color 6 (R255, G255, B000, W000)
49-55	Color 7 (R255, G255, B000, W075)
56-62	Color 8 (R000, G255, B000, W255)
63-69	Color 9 (R000, G255, B000, W150)
70-76	Color 10 (R000, G255, B000, W050)
77-83	Color 11 (R000, G255, B000, W000)
84-90	Color 12 (R000, G255, B050, W000)
91-97	Color 13 (R000, G255, B150, W000)
98-104	Color 14 (R000, G255, B255, W000)
105-111	Color 15 (R000, G255, B255, W075)
112-118	Color 16 (R000, G255, B255, W150)
119-125	Color 17 (R000, G100, B255, W255)
126-132	Color 18 (R000, G000, B255, W100)
133-139	Color 19 (R000, G000, B255, W050)
140-146	Color 20 (R000, G000, B255, W000)
147-153	Color 21 (R075, G000, B255, W000)
154-160	Color 22 (R160, G000, B255, W000)
161-167	Color 23 (R255, G000, B255, W000)
168-174	Color 24 (R255, G000, B175, W000)
175-181	Color 25 (R255, G000, B100, W000)
182-188	Color 26 (R255, G000, B100, W050)
189-195	Color 27 (R255, G000, B025, W050)
196-202	Color 28 (R255, G000, B025, W025)
203-209	Color 29 (R255, G000, B025, W000)
210-216	Color 30 (R000, G000, B000, W255)
217-223	Color 31 (R075, G075, B000, W255)
224-230	Color 32 (R000, G000, B100, W255)
231-255	Color 33 (R255, G255, B255, W255)

Channel 4 – Built-in programs (CH1 must be set between 1-255 )

0-15	No function
16-31	Jump 1
32-47	Jump 2
48-63	Jump 3
64-79	Jump 4
80-95	Jump 5
96-111	Jump 6
112-127	Jump 7
128-143	Jump 8
144-159	Fade 1
160-175	Fade 2
176-191	Fade 3
192-207	Fade 4
208-223	Fade 5
224-239	Fade 6
240-255	Fade 7

Channel 5 – Speed Built-in programs (CH4 must be set between 16-255 )

0-255	Speed adjustment, from fast to slow
-------	-------------------------------------

Channel 6 – Control functions (Hold DMX value for at least 2 sec. before the function will be activated)

0-15	No function
16-45	Dimmer fast
46-75	Dimmer slow
76-105	Linear curve
106-135	Square curve
136-165	Inv. Square curve
166-195	S-type curve

Channel 7 – Red Dimmer intensity (CH1 must be set between 1-255 ⚠)

0-255	Gradual adjustment Red from 0-100%
-------	------------------------------------

Channel 8 – Green Dimmer intensity (CH1 must be set between 1-255 ⚠)

0-255	Gradual adjustment Green from 0-100%
-------	--------------------------------------

Channel 9 – Blue Dimmer intensity (CH1 must be set between 1-255 ⚠)

0-255	Gradual adjustment Blue from 0-100%
-------	-------------------------------------

Channel 10 – White Dimmer intensity (CH1 must be set between 1-255 ⚠)

0-255	Gradual adjustment White from 0-100%
-------	--------------------------------------

Maintenance

The operator has to make sure that safety-related and machine-technical installations are to be inspected by an expert after every year in the course of an acceptance test.

The operator has to make sure that safety-related and machine-technical installations are to be inspected by a skilled person once a year.

The following points have to be considered during the inspection:

- 01) All screws used for installing the device or parts of the device have to be tightly connected and must not be corroded.
- 02) There may not be any deformations on housings, fixations and installation spots.
- 03) Mechanically moving parts like axles, eyes and others may not show any traces of wearing.
- 04) The electric power supply cables must not show any damages or material fatigue.

The EventSpot 1600 Q4 requires almost no maintenance. However, you should keep the unit clean. Otherwise, the fixture's light-output will be significantly reduced. Disconnect the mains power supply, and then wipe the cover with a damp cloth. Do not immerse in liquid. Wipe lens clean with glass cleaner and a soft cloth. Do not use alcohol or solvents.

The front lens will require weekly cleaning, as smoke-fluid tends to build up residues, reducing the light-output very quickly.

Keep connections clean. Disconnect electric power, and then wipe the DMX and audio connections with a damp cloth. Make sure connections are thoroughly dry before linking equipment or supplying electric power.

Troubleshooting

No Light

This troubleshooting guide is meant to help solve simple problems.

If a problem occurs, follow the steps below in sequence until a solution is found. Once the unit operates properly, do not carry out the following steps.

If the light effect does not operate properly, refer servicing to a technician.

Suspect three potential problem areas: the battery, the LEDs, the internal fuse.

- 01) Battery. Check if the battery is fully charged.
- 02) The LEDs. Return the EventSpot 1600 Q4 to your Showtec dealer.
- 03) The internal fuse. Return the EventSpot 1600 Q4 to your Showtec dealer.
- 04) If all of the above appears to be in order, switch the unit on again.
- 05) If you are unable to determine the cause of the problem, do not open the EventSpot 1600 Q4, as this may damage the unit and the warranty will become void.
- 06) Return the device to your Showtec dealer.

No Response to DMX

Response: Suspect the DMX cable or connectors, a controller malfunction, a light effect DMX card malfunction.

- 01) Check the DMX setting. Make sure that DMX addresses are correct.
- 02) Check the DMX cable: Unplug the unit; change the DMX cable; then reconnect to electrical power. Try your DMX control again.
- 03) Determine whether the controller or light effect is to blame. Does the controller operate properly with other DMX products? If not, take the controller in for repair. If it does, take the DMX cable and the light effect to a qualified technician.

Problem	Probable cause(s)	Solution
One or more fixtures do not function at all	No power to the fixture	<ul style="list-style-type: none"> • Check that power is switched on and the battery is charged
	Internal fuse blown	<ul style="list-style-type: none"> • Return the device to your local Showtec dealer
Fixtures reset correctly, but all respond erratically or not at all to the controller	The controller is not connected	<ul style="list-style-type: none"> • Connect controller
	3-pin XLR Out of the controller does not match XLR Out of the first fixture on the link (i.e. signal is reversed)	<ul style="list-style-type: none"> • Install a phase reversing cable between the controller and the first fixture on the link
Fixtures reset correctly, but some respond erratically or not at all to the controller	Poor data quality	<ul style="list-style-type: none"> • Check data quality. If much lower than 100 percent, the problem may be a bad data link connection, poor quality or broken cables, missing termination plug, or a defective fixture disturbing the link
	Bad data link connection	<ul style="list-style-type: none"> • Inspect connections and cables. Correct poor connections. Repair or replace damaged cables
	Data link not terminated with 120 Ohm termination plug	<ul style="list-style-type: none"> • Insert termination plug in output jack of the last fixture on the link
	Incorrect addressing of the fixtures	<ul style="list-style-type: none"> • Check address setting
	One of the fixtures is defective and disturbs data transmission on the link	<ul style="list-style-type: none"> • Bypass one fixture at a time until normal operation is restored: unplug both connectors and connect them directly together. • Have the defective fixture serviced by a qualified technician
	3-pin XLR Out on the fixtures does not match (pins 2 and 3 reversed)	<ul style="list-style-type: none"> • Install a phase-reversing cable between the fixtures or swap pin 2 and 3 in the fixture that behaves erratically
No light or LEDs cuts out intermittently	Fixture is too hot	<ul style="list-style-type: none"> • Allow the fixture to cool down • Clean the fan • Make sure air vents in control panel and the front lens are not blocked • Turn up the air conditioning
	LEDs damaged	<ul style="list-style-type: none"> • Disconnect the fixture and return it to your dealer
	The power supply settings do not match local AC voltage and frequency	<ul style="list-style-type: none"> • Disconnect fixture. Check settings and correct if necessary

Product Specifications

Model:	Showtec EventSpot 1600 Q4
Input Voltage:	100-240V AC, 50/60 Hz
Drive current:	650mA
Refresh rate:	12KHz
Battery storage:	15,6Ah
Operating time at full RGBW:	8 hours
Operation temperature:	-10°to +40°
Battery type:	Litium ion
Charging time:	6 hours
Voltage:	18,5V
Spare battery:	On request
Protection rate:	IP54
Dimensions:	180 x 180 x 280 mm (LxWxH)
Weight:	5,0 kg
Operating and Programming:	
Signal pin OUT:	Pin 1 (earth), pin 2 (-), pin 3 (+)
DMX Mode:	4, 6 or 10 channels
Signal input:	3-pin DMX IN
Signal output:	3-pin DMX OUT
Electro-mechanical effects:	
LED Quantity:	4 x 12W RGBW LEDs
Color mixing:	RGBW
Beam angle:	10°
Liminus flux:	1580
Lux@2m:	15000
Dimmer:	0-100%
Strobe:	0-15Hz
Housing:	Black aluminum and iron
DMX-control:	DMX512 via wireless/ DMX512
On Board:	OLED display for easy setup
Control:	Built-in programs, Auto, Manual, Master/Slave, DMX, W-DMX
Connections:	Dedicated 3-pin XLR IN/OUT IP54
Cooling:	Aluminum heatsink
Max. ambient temperature t_a :	40°C
Max. housing temperature t_B :	80°C
Minimum distance:	
Minimum distance from flammable surfaces:	0,5 m
Minimum distance to lighted object:	1 m

Design and product specifications are subject to change without prior notice.



Website: www.Showtec.info

Email: service@highlife.com

Dimensions

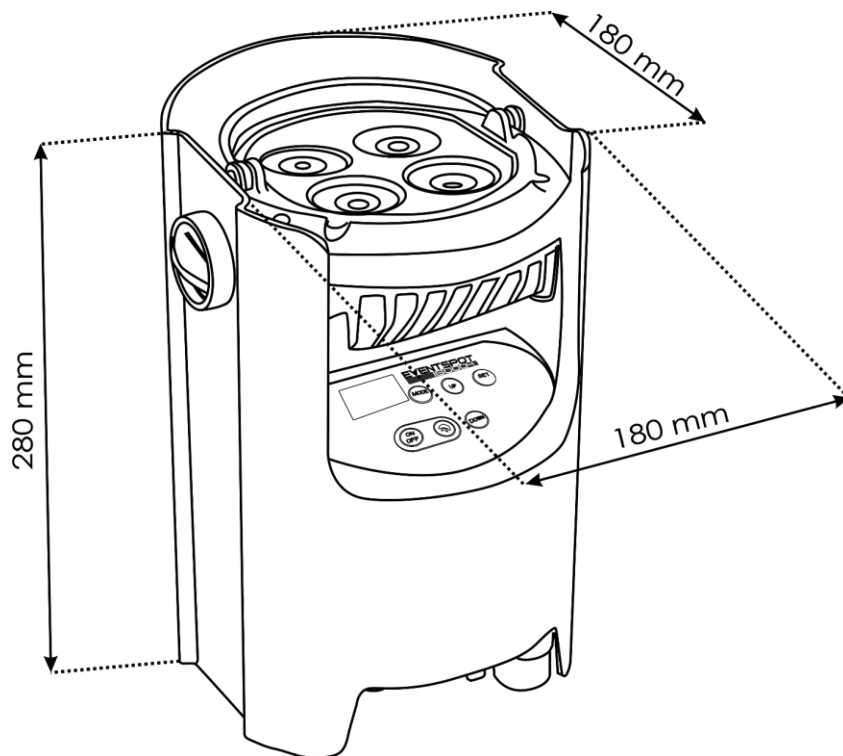



©2018 Showtec