

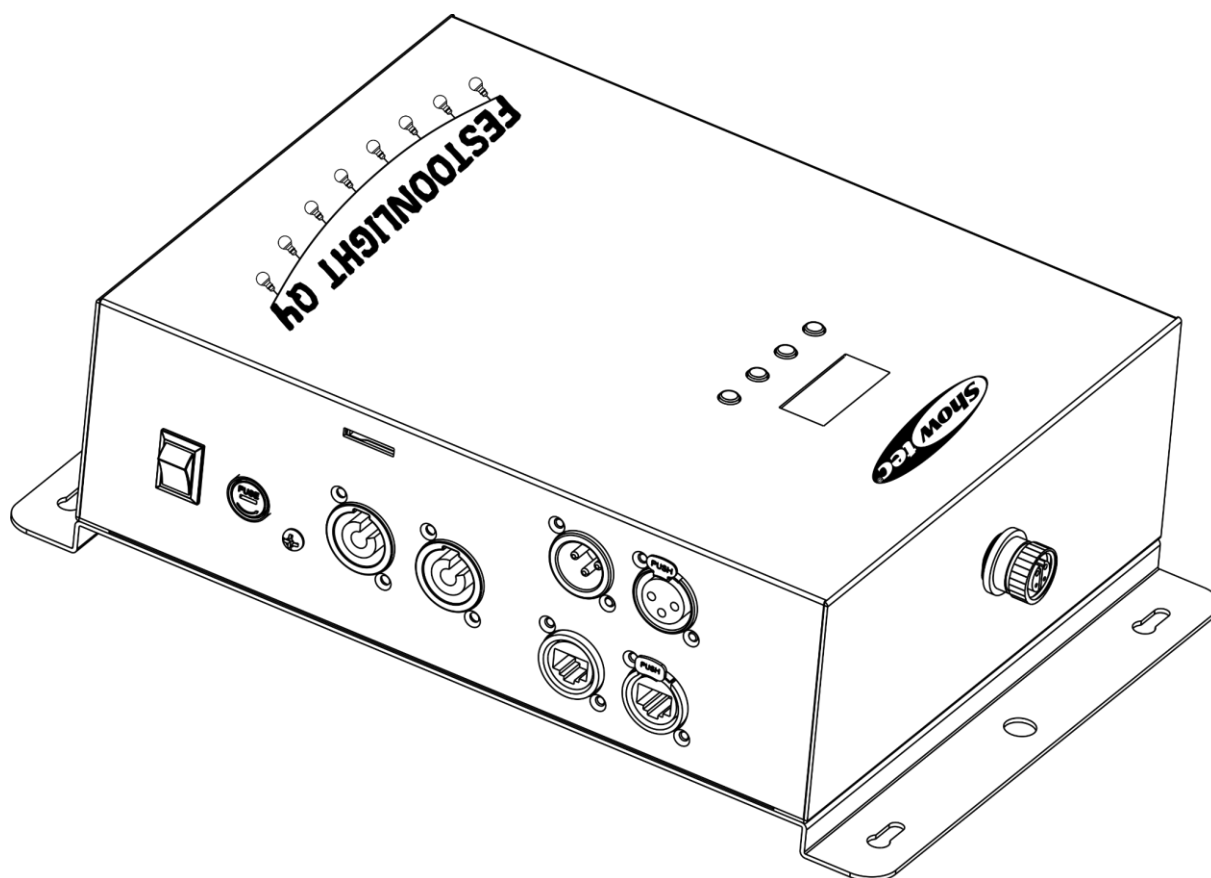

MANUAL



ENGLISH

Festoonlight Q4 Controller

V1

**Order code: 41750
Firmware version: 1.0.4**

Table of contents

Warning 3

 Safety Instructions 3

 Operating Determinations 5

 Rigging 5

 Connection with the Mains 5

 Return Procedure 6

 Claims 6

Description of the Device 7

 Top view 8

 Side view 8

Installation 9

 Setup with 1–3 Festoonlight Q4 Strings 9

 Setup with 4–6 Festoonlight Q4 Strings 10

Setup and Operation 11

 Multiple Fixtures Power Linking 11

 Control Modes 11

 One Festoonlight Controller (Built-in programs) 11

 Multiple Festoonlight Controllers (DMX Control) 12

 Multiple Festoonlight Controllers (Art-Net Control) 13

 Connecting to a Network 14

 Art-Net Settings 14

 How To Make a Data Cable 15

 Fixture Linking 16

 Data Cabling 16

 Control Panel 17

 DMX Addressing 17

 Menu Overview 18

 Start-up 19

 Main Menu Options 19

 1. Programs 19

 2. Art-Net 20

 3. DMX-IN 20

 4. Settings 20

 4.1. Lock Screen 21

 4.2. IP Address 21

 4.3. Channel Modes 21

 4.4. Factory Default 21

 5. Info 22

 6. Lamp Test 22

 DMX Channels 23

 4 channels (Basic) 23

 4 channels (RGBW) 24

 8 channels (Odd/Even) 24

 8 channels (Party) 25

 80 channels (20 Pixel) 26

 480 channels (Full Pixel) 26

Maintenance 28

 Replacing the Fuse 28

Troubleshooting 28

 No Light 28

 No Response to DMX 28

Product Specifications30

Dimensions.....31

Notes32

Warning



**For your own safety, please read this user manual carefully
before your initial start-up!**



Unpacking Instructions

Immediately upon receiving this product, carefully unpack the carton and check the contents to ensure that all parts are present, and have been received in good condition. Notify the dealer immediately and retain packing material for inspection if any parts appear damaged from shipping or the carton itself shows signs of mishandling. Save the carton and all packing materials. In the event that a fixture must be returned to the factory, it is important that the fixture will be returned in the original factory box and packing.

Your shipment includes:

- Showtec Festoonlight Q4 Controller
- Extension cord (10 m)
- Pro power to Schuko power cable (1,5 m)
- Mounting bracket with quick locks
- User manual

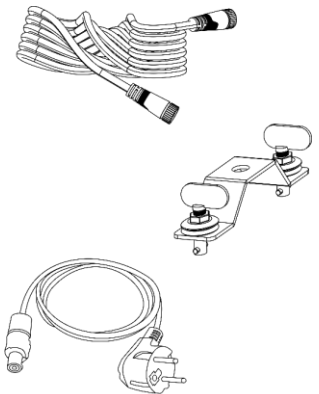
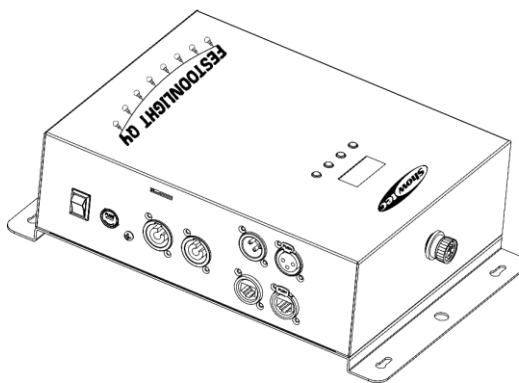

CAUTION!
Keep this device away from rain and moisture!
Unplug mains lead before opening the housing!



Safety Instructions

Every person involved with the installation, operation and maintenance of this device has to:

- be qualified
- follow the instructions of this manual



CAUTION! Be careful with your operations.
**With a dangerous voltage you can suffer
a dangerous electric shock when touching the wires!**



Before the initial start-up, please make sure that there is no damage caused by transportation. Should there be any, consult your dealer and do not use the device.

To maintain perfect condition and to ensure a safe operation, it is absolutely necessary for the user to follow the safety instructions and warning notes contained in this manual.

Please consider that damages caused by manual modifications to the device are not subject to warranty.

This device contains no user-serviceable parts. Refer servicing to qualified technicians only.

IMPORTANT:

The manufacturer will not accept liability for any resulting damages caused by the non-observance of this manual or any unauthorized modification to the device.

- Never let the power cord come into contact with other cables! Handle the power cord and all connections with the mains with particular caution!
- Never remove warning or informative labels from the unit.
- Never use anything to cover the ground contact.
- Never leave any cables lying around.
- Do not insert objects into air vents.
- Do not connect this device to a dimmer pack.
- Do not switch the device on and off in short intervals, as this will reduce the device's life.
- Do not touch the device's housing bare-handed during its operation. Allow the fixture to cool for at least 5 minutes before handling.
- Do not shake the device. Avoid brute force when installing or operating the device.
- Only use the device indoors, avoid contact with water or other liquids.
- Only operate the fixture after having checked if the housing is firmly closed and all screws are tightly fastened.
- Only operate the device after having familiarized with its functions.
- Avoid flames and do not put close to flammable liquids or gases.
- Always keep the housing closed while operating.
- Always allow a free air space of at least 50 cm around the unit for ventilation.
- Always disconnect power from the mains, when device is not used or before cleaning! Only handle the power cord holding it by the plug. Never pull out the plug by tugging the power cord.
- Make sure that the device is not exposed to extreme heat, moisture or dust.
- Make sure that the available voltage is not higher than stated on the rear panel.
- Make sure that the power cord is never crimped or damaged. Check the device and the power cord from time to time.
- If device was dropped or struck, disconnect mains power supply immediately. Have a qualified engineer inspect for safety before operating.
- If the device has been exposed to drastic temperature fluctuation (e.g. after transportation), do not switch it on immediately. The arising condensation water might damage your device. Leave the device switched off until it has reached room temperature.
- If your Showtec device fails to work properly, discontinue the use immediately. Pack the unit securely (preferably in the original packing material), and return it to your Showtec dealer for service.
- For adult use only. The fixture must be installed beyond the reach of children. Never leave the unit running unattended.
- Never attempt to bypass the thermostatic switch or fuses.
- The user is responsible for correct positioning and operating of the Controller. The manufacturer will not accept liability for damages caused by the misuse or incorrect installation of this device.
- This device falls under protection class I. Therefore it is essential to connect the yellow/green conductor to earth.
- Repairs, servicing and electric connection must be carried out by a qualified technician.
- WARRANTY: Till one year after date of purchase.

Operating Determinations

- This device is not designed for permanent operation. Consistent operation breaks will ensure that the device will serve you for a long time without defects.
- The maximum ambient temperature $t_a = 40\text{ °C}$ must never be exceeded.
- In order to eliminate wear and improve the device's lifespan, during periods of non-use, completely disconnect from power source via breaker or by unplugging.
- The relative humidity must not exceed 50 % with an ambient temperature of 40 °C .
- If this device is operated in any other way, than the one described in this manual, the product may suffer damages and the warranty becomes void.
- Any other operation may lead to dangers like short-circuit, burns, electric shock, crash etc.

You endanger your own safety and the safety of others!

Rigging

Please follow the European and national guidelines concerning rigging, trussing and all other safety issues.

Improper installation can cause serious injuries and/or damage of property!

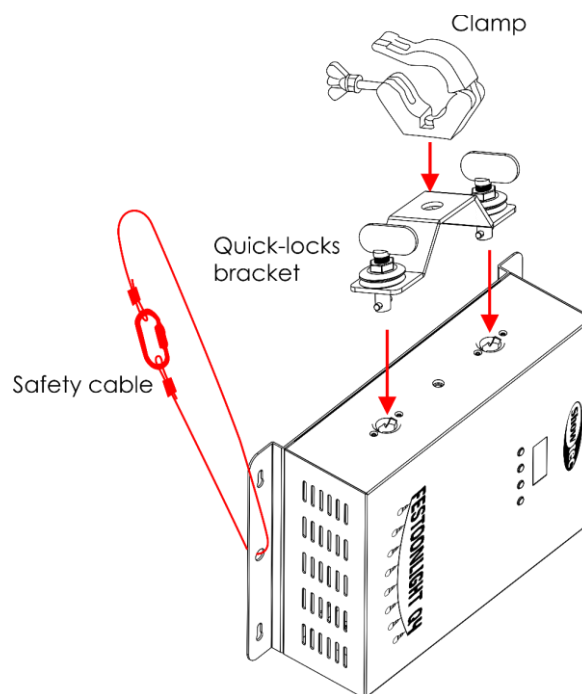

Fig. 01

The Controller can be placed on a flat surface or mounted to any kind of truss, with a clamp and the included mounting bracket with quick locks.

Connection with the Mains

Connect the device to the mains with the power-plug.

Always check if the right color cable is connected to the right place.

International	EU Cable	UK Cable	US Cable	Pin
L	BROWN	RED	YELLOW/COPPER	PHASE
N	BLUE	BLACK	SILVER	NEUTRAL
⊕	YELLOW/GREEN	GREEN	GREEN	PROTECTIVE GROUND

Make sure that the device is always properly connected to the earth!

Improper installation can cause serious injuries and/or damage of property!



Return Procedure

Returned merchandise must be sent prepaid and in the original packing, call tags will not be issued. Package must be clearly labeled with a Return Authorization Number (RMA number). Products returned without an RMA number will be refused. Highlite will not accept the returned goods or any responsibility. Call Highlite 0031-455667723 or mail aftersales@highlite.com and request an RMA prior to shipping the fixture. Be prepared to provide the model number, serial number and a brief description of the cause for the return. Be sure to properly pack fixture, any shipping damage resulting from inadequate packaging is the customer's responsibility. Highlite reserves the right to use its own discretion to repair or replace product(s). As a suggestion, proper UPS packing or double-boxing is always a safe method to use.

Note: If you are given an RMA number, please include the following information on a piece of paper inside the box:

- 01) Your name
- 02) Your address
- 03) Your phone number
- 04) A brief description of the symptoms

Claims

The client has the obligation to check the delivered goods immediately upon delivery for any shortcomings and/or visible defects, or perform this check after our announcement that the goods are at their disposal. Damage incurred in shipping is the responsibility of the shipper; therefore the damage must be reported to the carrier upon receipt of merchandise.

It is the customer's responsibility to report and submit claims with the shipper in the event that a fixture is damaged due to shipping. Transportation damage has to be reported to us within one day after receipt of the delivery.

Any return shipment has to be made post-paid at all times. Return shipments must be accompanied with a letter defining the reason for return shipment. Non-prepaid return shipments will be refused, unless agreed otherwise in writing.

Complaints against us must be prepared in writing or sent by fax within 10 working days after receipt of the invoice. After this period complaints will not be handled anymore.

Complaints will only then be considered if the client has so far complied with all parts of the agreement, regardless of the agreement from which the obligation is resulting.

Description of the Device

Features

The Festoonlight Q4 Controller is designed to be operated with the Festoonlight Q4 Strings. It offers full pixel control for up to 3 strings. To extend the setup to a maximum of 6 strings, you will need the optional Festoonlight Q4 Booster.

- Power supply: 100–240 V AC, 50/60 Hz
- Power consumption: 110 W (max at full output)
- Control protocol: DMX-512, Art-Net
- Built-in programs: 30 programs
- DMX channels: Basic (4 channels), RGBW (4 channels), Odd/Even (8 channels), Party (8 channels), 20 Pixel (80 channels), Full Pixel (480 channels)
- Connectors: Pro power connectors IN/OUT, 3-pin DMX connectors IN/OUT, RJ45 connectors IN/OUT, dedicated Festoonlight Q4 String connector
- Control modes: Built-in programs, DMX, Art-Net
- Maximum number of strings: 3 without a booster (6 with a booster)
- Maximum length: 90 m
- Cooling: Convection
- IP rating: IP20
- Fuse: T2 A/250 V
- Dimensions: 315 x 200 x 93 mm (L x W x H)
- Weight: 2,3 kg (without mounting bracket)



The Festoonlight Q4 Controller is designed to be operated together with the Festoonlight Q4 String.

Note: The Festoonlight Q4 Controller is delivered without the Festoonlight strings. You need to purchase the Festoonlight strings separately. You can connect up to 3 strings to the controller without a booster. With a booster you can extend the setup to a maximum of 6 strings.

[41751](#) – Festoonlight Q4 String

[41752](#) – Festoonlight Q4 Booster

Top view

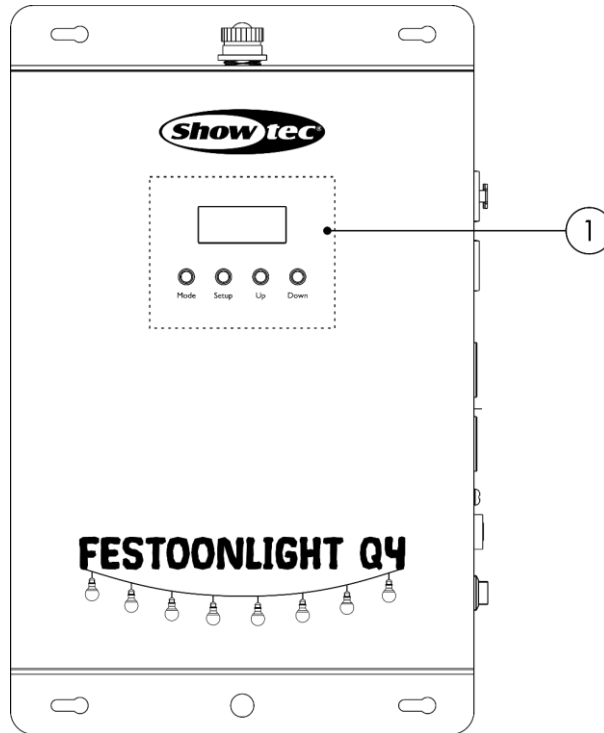

Fig. 02

01) Control panel: LCD display and buttons

Side view

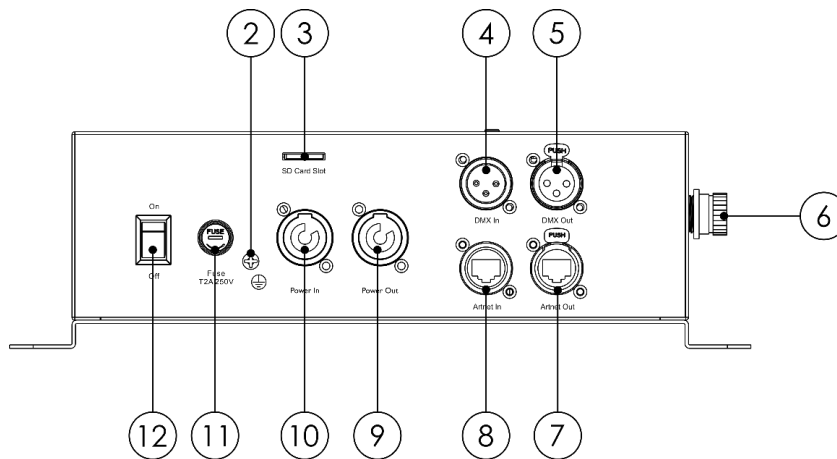

Fig. 03

- 02) Ground/earth connection
- 03) SD-card slot with mini SD-card



Do not take the mini SD-card out of the SD-card slot! The built-in programs are recorded on the mini SD-card.

- 04) 3-pin DMX connector IN
- 05) 3-pin DMX connector OUT
- 06) Dedicated Festoonlight String connector
- 07) RJ45 connector
- 08) RJ45 connector
- 09) Pro power connector OUT (Gray)
- 10) Pro power connector IN (Blue)
- 11) Fuse T2 A/250 V
- 12) Power switch ON/OFF

Installation

Remove all packing materials from the Festoonlight Q4 Controller. Check if all foam and plastic padding is removed.



The Festoonlight Q4 Controller must be installed indoors.

The Festoonlight Q4 Strings can be installed outdoors. However, they are not designed for permanent outdoor use.



Always terminate the open end of the Festoonlight Q4 String when installed outdoors.

Setup with 1–3 Festoonlight Q4 Strings

- 01) Connect the Festoonlight Q4 String to the dedicated connector **(06)** on the Festoonlight Q4 Controller.
- 02) Use the supplied extension cord, if necessary.

Note: Do not use more than 1 extension cord for each controller in the setup.

- 03) Connect the 2nd and the 3rd Festoonlight Q4 Strings in a continuous line to the 1st Festoonlight Q4 String.

Note: You can connect up to 3 Festoonlight Q4 Strings to the controller without a booster.

- 04) Terminate the open end of the last string on the line with the end cap delivered with the Festoonlight Q4 String.

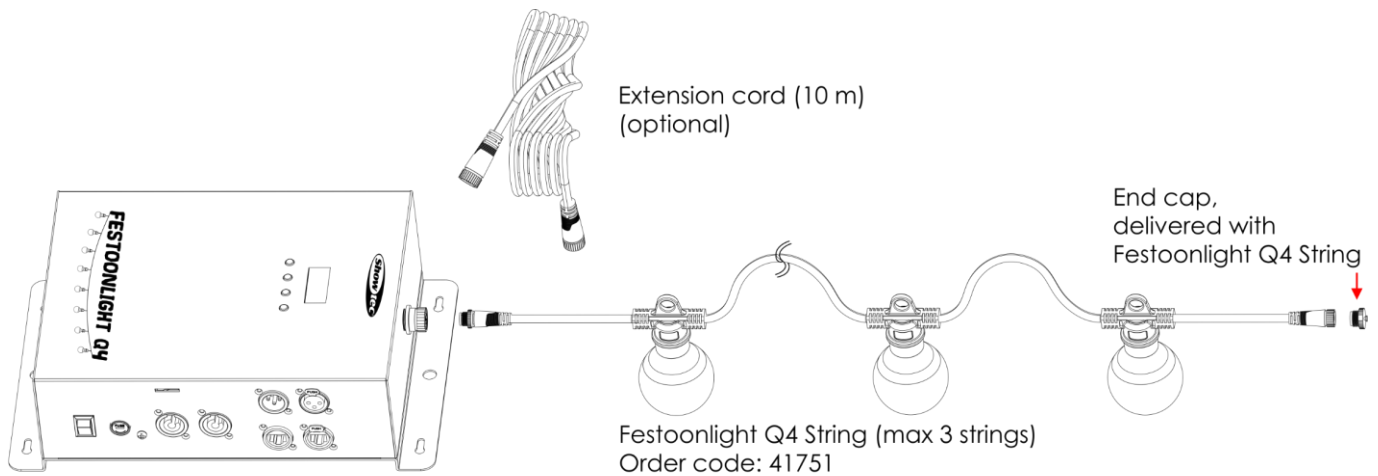

Festoonlight Q4 Controller
Order code: 41750

Fig. 04

Setup with 4–6 Festoonlight Q4 Strings

- 01) Follow steps 1–3 from **Setup with 1–3 Festoonlight Q4 Strings** to connect the first 3 strings.
- 02) Connect the splitter cable of the Festoonlight Q4 Booster to the 3rd string.
- 03) Connect the 4th string to the splitter cable of the booster.
- 04) Connect the 5th and the 6th strings in a continuous line to the 4th string.

Note: You can connect up to 6 Festoonlight Q4 Strings if you use a booster.

- 05) Terminate the open end of the last string on the line with the end cap delivered with the Festoonlight Q4 String.

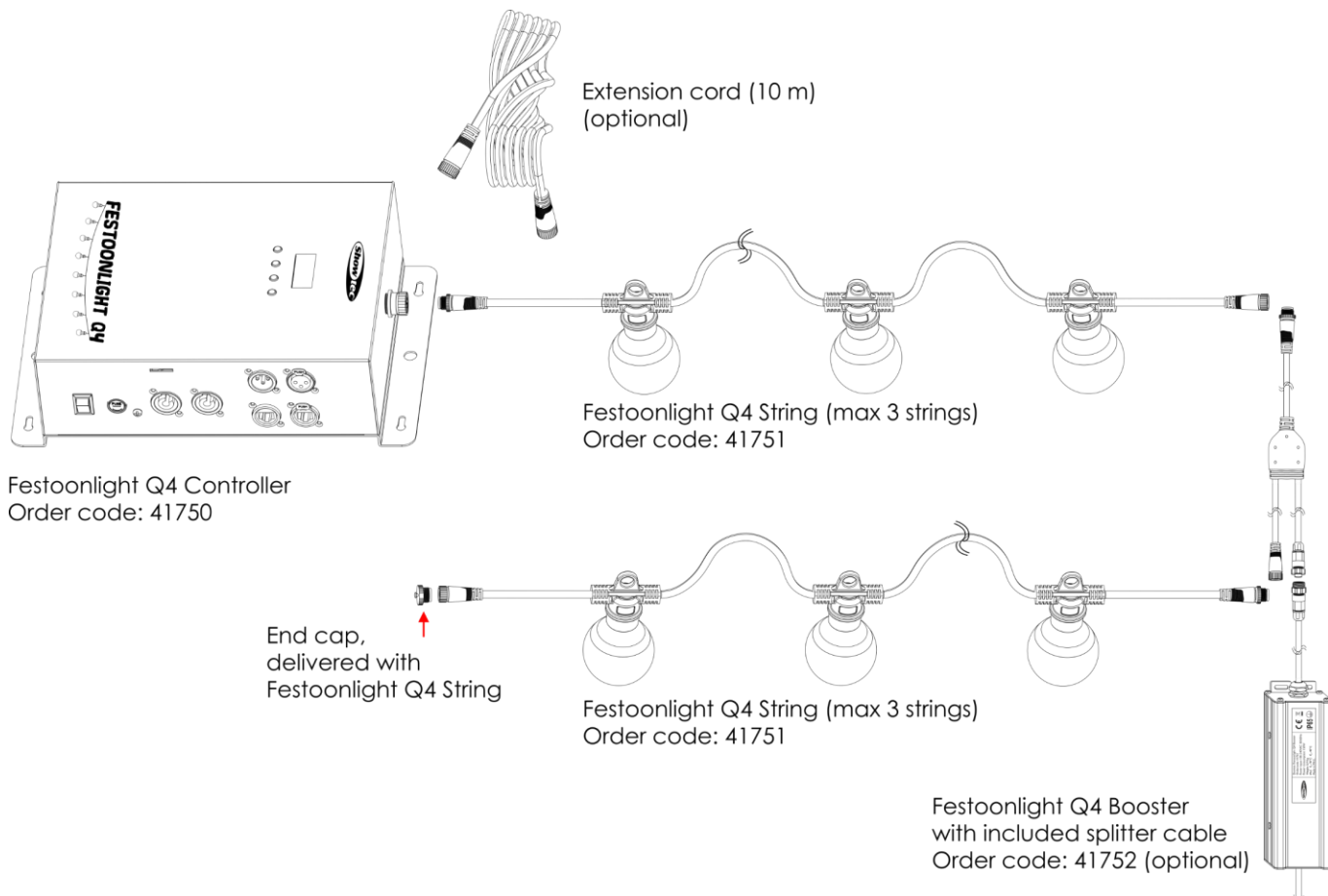

Fig. 05

**Do not supply power before the whole system is set up and connected properly.
Always disconnect from electric mains power supply before cleaning or servicing.
Damages caused by non-observance are not subject to warranty.**

Setup and Operation

Follow the directions below, as they pertain to your preferred operation mode.

Before plugging the unit in, always make sure that the power supply matches the product specification voltage. Do not attempt to operate a 120 V specification product on 230 V power, or vice versa. Connect the device to the main power supply.

Multiple Fixtures Power Linking

The Festoonlight Q4 Controller supports power linking. Power can be relayed to another device via the power OUT connector. Note that the input and the output connectors have different designs: one type cannot be connected to the other.

To link fixtures in a chain, a hard usage cable with appropriate cable jacket must be used. Power linking cables are available for purchase from Highlite International.

To prevent power overload and damage to the fixture, do not link more fixtures in one chain than recommended. After you have reached the maximum number of fixtures, use a new power outlet.



For setups with 3 Festoonlight Q4 Strings

Maximum recommended number of fixtures on a power link @ 110 V: 7 fixtures

Maximum recommended number of fixtures on a power link @ 240 V: 15 fixtures

Control Modes

There are 2 modes:

- Stand-alone (Built-in programs)
- DMX-512/Art-Net: Basic (4 channels), RGBW (4 channels), Odd/Even (8 channels), Party (8 channels), 20 Pixel (80 channels), Full Pixel (480 channels)

One Festoonlight Controller (Built-in programs)

- 01) Fasten the controller to a firm trussing or place it on a flat surface. Leave at least 0,5 meter on all sides for air circulation. See **Rigging** on page 5.
- 02) Connect the Festoonlight Q4 String(s). See pages 9–10 for more information.
- 03) Plug the end of the electric mains power cord into a proper electric power supply socket.
- 04) When the controller is not connected by means of a DMX cable, it functions as a stand-alone device.
- 05) Please see **1. Programs** on page 19 for more information.

Multiple Festoonlight Controllers (DMX Control)

- 01) Fasten the controller to a firm trussing or place it on a flat surface. Leave at least 0,5 meter on all sides for air circulation. See **Rigging** on page 5.
- 02) Connect the Festoonlight Q4 String(s). See pages 9–10 for more information.
- 03) Use a 3-pin DMX cable to connect the controllers.

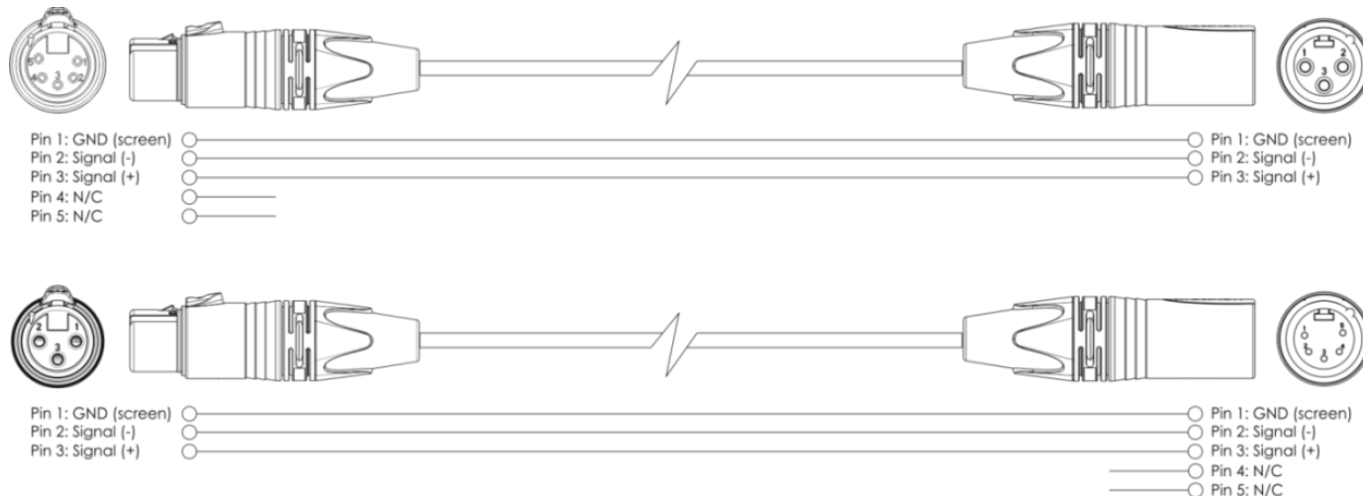

- 04) Link the units as shown in Fig. 07. Connect a light controller to the first unit's DMX "in" socket, using a DMX cable. Connect the first unit's "out" socket with the second unit's "in" socket, using a DMX cable. Repeat this process to link the rest of the units.
- 05) Supply electric power: Plug electric mains power cords into each unit's power IN socket, then plug the other end of the mains power cord into proper electric power supply sockets, starting with the first unit. Do not supply power before the whole system is set up and connected properly.

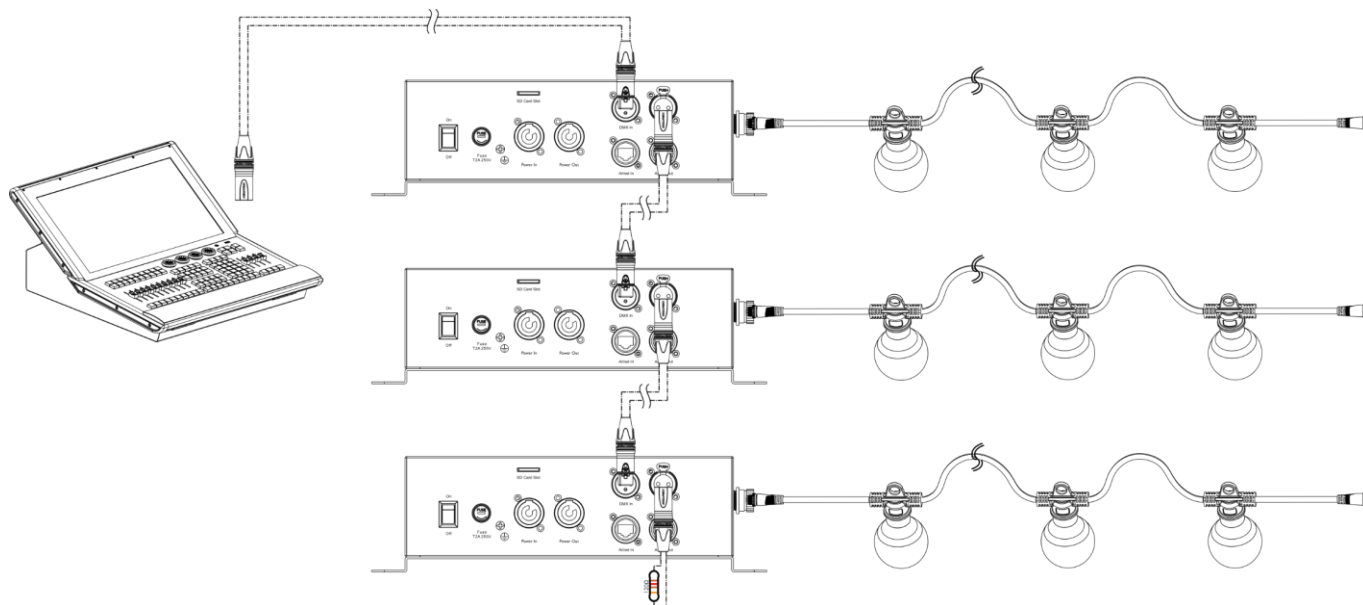

Fig. 07

Note: Link all cables before connecting electric power

Multiple Festoonlight Controllers (Art-Net Control)

- 01) Fasten the controller to a firm trussing or place it on a flat surface. Leave at least 0,5 meter on all sides for air circulation. See **Rigging** on page 5.
- 02) Connect the Festoonlight Q4 String(s). See pages 9–10 for more information.
- 03) Use a CAT-5/CAT-6 cable to connect the controllers.
- 04) Connect your computer with installed Art-Net software to the first device's RJ45 "in" socket.
- 05) Link the units as shown in Fig. 08. Connect the first unit's RJ45 "out" socket with the second unit's "in" socket, using a CAT-5/CAT-6 cable. Repeat this process to link the rest of the units.
- 06) Supply electric power: Plug electric mains power cords into each unit's power IN socket, then plug the other end of the mains power cord into proper electric power supply sockets, starting with the first unit. Do not supply power before the whole system is set up and connected properly.

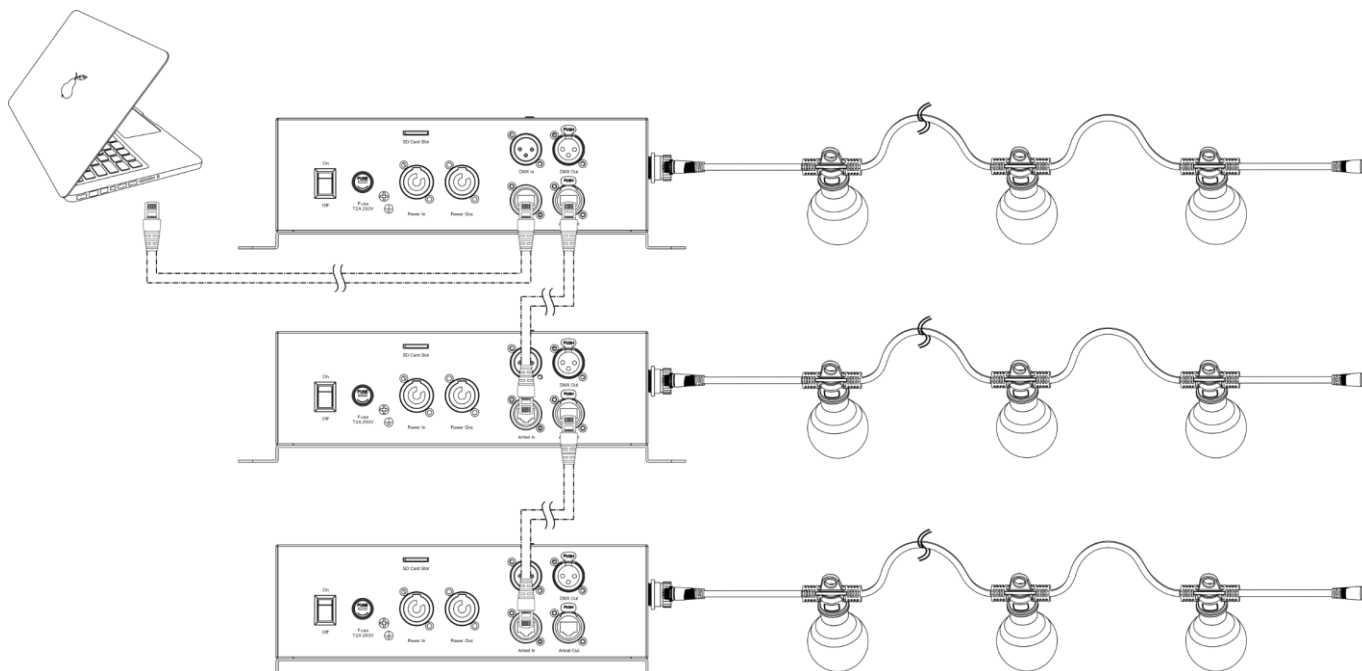

Fig. 08

Note: Link all cables before connecting electric power

Connecting to a Network

Art-Net Settings

- 01) Connect the device's RJ45 connector to the RJ45 connector of the lighting controller/computer, using a CAT-5/CAT-6 cable.
- 02) Set the IP address of your computer/lighting controller to **2.x.x.x** or **10.x.x.x**, depending on the Art-Net settings.
- 03) Set the Subnet Mask to **255.0.0.0** on all devices.
- 04) Make sure that all fixtures in the network have a **unique IP address**.
- 05) If you want to connect more fixtures, follow the example below.

Note: When creating large setups, it is recommended to use a 16-bit, high speed Ethernet switch to distribute the Art-Net data signal.

Example settings:

If you want to connect multiple Festoonlight Q4 Controllers using Art-Net protocol, proceed as follows:

- 01) Set the DMX starting address of the 1st Festoonlight Q4 Controller to **1**.
- 02) If you want to operate the Festoonlight Q4 Controller in 8-channel DMX mode, for example, set the DMX starting address of the 2nd Festoonlight Q4 Controller to **9**, of the 3rd to **17**, etc. See **DMX Addressing** on page 17 for more information.
- 03) Once you have reached the limit of 512 DMX addresses, set the port of the next Festoonlight Q4 Controller to **1**. Thus, there are again 512 DMX channels available and you can connect more devices.
- 04) When you reach port **15**, for the next Festoonlight Q4 Controller set the sub to **1** and the port to **0**. Continue connecting devices, each time inserting ascending numbers for the port and the sub.
- 05) For larger setups, when you reach sub 15 and port 15, set the net to **1**. You can continue connecting devices until you reach the limit of 128 nets.

There are 512 channels in 1 universe. The universe number is made up of the sub and the port numbers (sub:port). Thus, the number of the 1st universe will be 0:0, the number of the 2nd – 0:1, etc. There are 256 universes in 1 net. The last universe in the net will have the number 15:15. There are 128 nets, or 32768 universes in total.

Note: Counting begins at 0.

Universe addressing

Universe	Net	Sub	Port
1	0	0	0
2	0	0	1
3	0	0	2
...
17	0	1	0
...
256	0	15	15
257	1	0	0
...
32768	127	15	15

Art-Net is a protocol that uses TCP/IP to transfer large amount of DMX-512 data over an Ethernet network. Art-Net 4 can support up to 32768 universes. Art-Net™ Designed by and Copyright Artistic Licence Holdings Ltd.

How To Make a Data Cable

A standard ETHERNET cable can be used to replace the data cable required to transmit the data.

Please follow the instructions below in order to create an extra network cable.

Take a standard network cable (CAT-5/ 5E /6) and connect it to the RJ45 connector, as shown in Fig. 09. The wires should now be colored as follows:

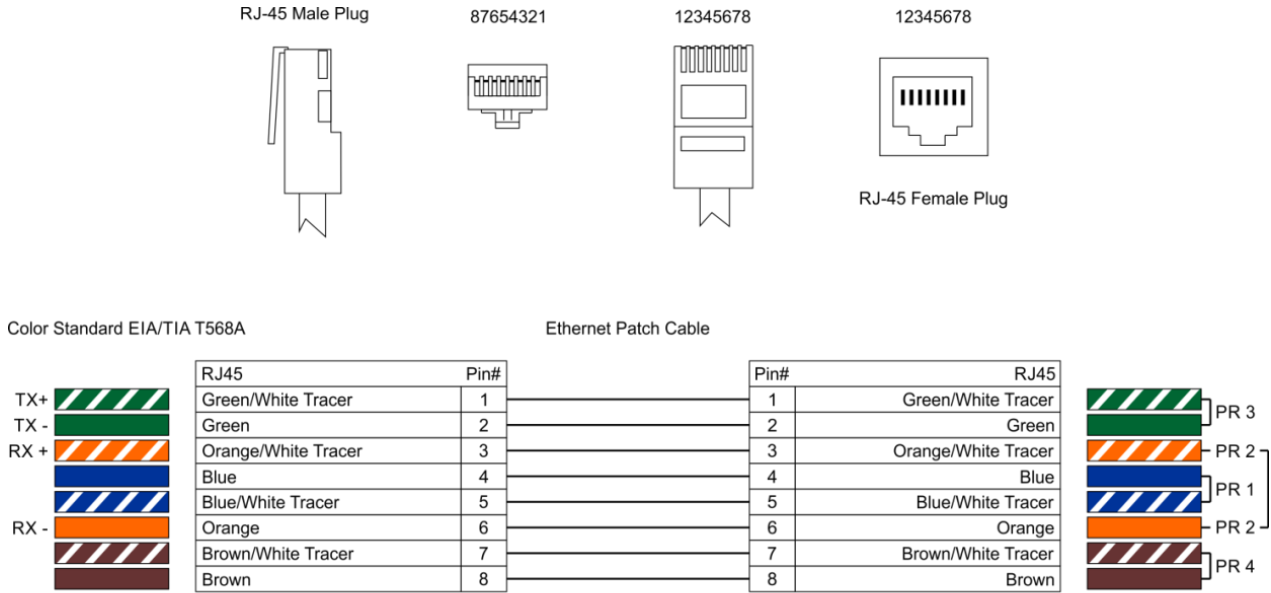

Fig. 09

Fixture Linking

You will need a serial data link to run light shows of one or more fixtures using a DMX-512 controller. The combined number of channels required by all the fixtures on a serial data link determines the number of fixtures the data link can support.

Important: Fixtures on a serial data link must be daisy-chained in a single line. To comply with the EIA-485 standard, no more than 30 devices should be connected on one data link. Connecting more than 30 fixtures on one serial data link without the use of a DMX optically isolated splitter may result in deterioration of the digital DMX signal.



Maximum recommended DMX data link distance: 100 meters
Maximum recommended number of fixtures on a DMX data link: 30 fixtures

Data Cabling

To link fixtures together, you must obtain data cables. You can purchase DAP Audio certified DMX cables directly from a dealer/distributor or construct your own cable. If you choose to create your own cable, please use data-grade cables that can carry a high quality signal and are less prone to electromagnetic interference.

DAP Audio DMX Data Cables

- DAP Audio 110 Ohm cable with digital signal transmission. **Order code** FL0975 (0,75 m), FL09150 (1,5 m), FL093 (3 m), FL096 (6 m), FL0910 (10 m), FL0915 (15 m), FL0920 (20 m).
- DAP Audio DMX Terminator 3-pin. **Order code** FLA42.

Note: Use of 3-pin XLR audio cables for DMX data transmission might lead to signal degradation and unreliable operation of the DMX network.

DAP Audio PC Interface Cables

- CAT-5 cable 7,6 mm Matte blue PVC. **Order code** FL55150 (1,5 m), FL553 (3 m), FL556 (6 m), FL5510 (10 m), FL5515 (15 m), FL5520 (20 m).
- CAT-6 cable (recommended for best data transfer). **Order code** FL563 (3 m), FL566 (6 m), FL5610 (10 m), FL5615 (15 m), FL5640 (40 m).

The Festoonlight Q4 Controller can be operated with controller or without controller in stand-alone mode.

Control Panel

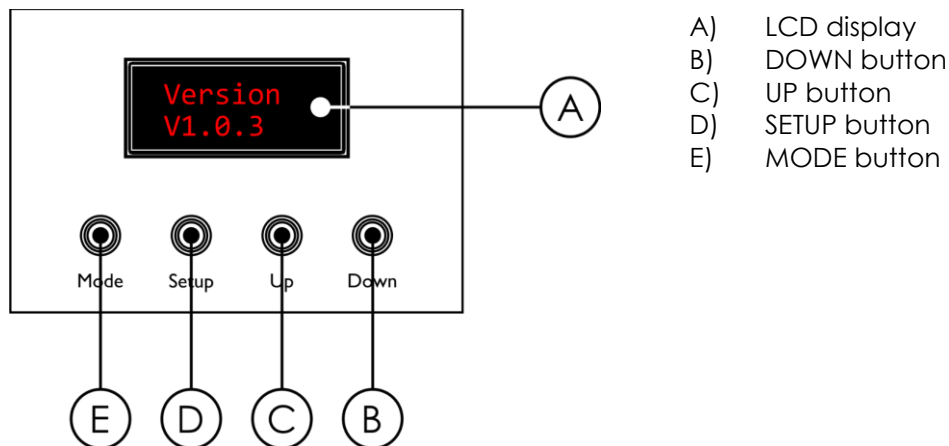

Fig. 10

DMX Addressing

The control panel on the top side of the controller allows you to assign the fixture a DMX address, which is the first channel with which the Festoonlight Q4 Controller will respond to a DMX controller.

When using multiple Festoonlight Controllers, make sure you set the DMX addresses right.

Without pixel control, the device has **8** channels. Therefore, the DMX address of the first Festoonlight Q4 Controller should be **1 (001)**; the DMX address of the second Festoonlight Q4 Controller should be **1+8=9 (009)**; the DMX address of the third Festoonlight Q4 Controller should be **9+8=15 (015)**, etc.

Make sure that you do not have any overlapping channels in order to control each Festoonlight Q4 Controller correctly. If two or more Festoonlight Q4 Controllers are addressed similarly, they will work similarly.

Note: If you want to connect multiple devices and operate them in full pixel mode (**480-channel** mode), you need to use Art-Net. See **Art-Net Settings** on page 14 for more information.

Controlling:

After having addressed all Festoonlight Controller fixtures, you may now start operating these via your lighting controller.

Note: After switching on, the Festoonlight Q4 Controller does not automatically detect whether DMX-512 data is received or not. You will need to switch manually to DMX control. For more information see **3. DMX-IN** on page 20.

Note: It is necessary to insert a termination plug (with 120 Ohm) in the last fixture in order to ensure proper transmission on the DMX data link.

Menu Overview



Start-up

At start-up the display will show the current version of the firmware and all bulbs on the connected Festoonlight Q4 String(s) will light up in blue for 2 seconds.

By default the display of the device is locked. To unlock the display and access the Main Menu, you will need to enter the **password**:

01) Press any key to light up the display. The following prompt screen will appear on the display:

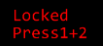

02) Press the **MODE** and **SETUP** buttons at the same time to unlock the display.

To change the settings and remove the display lock, see **4.1. Lock Screen** on page 21.

If no button is pressed, after 60 seconds the display will turn off. Enter the password to unlock the display. If the display lock is turned off, press any button to turn the display on.

- Use the **MODE** button to navigate through the Main Menu, to exit the current menu and/or to return to the Main Menu.
- Use the **SETUP** button to open the desired menu, to confirm your choice or to set the currently selected value.
- Use the **UP/DOWN** buttons to navigate through the submenus or to increase/decrease numeric values.

Main Menu Options

The Main Menu has the following options:

Programs	Built-in programs
Art-Net	Art-Net
DMX-IN	DMX-512
Settings	Settings
Info	Firmware information
LampTest	Lamp test

1. Programs

In this menu you can start one of the built-in programs.

01) Press the **MODE** button to navigate through the Main Menu until the display shows



02) Press the **SETUP** button to open the menu.

03) Press the **UP/DOWN** buttons to select one of the 30 built-in programs.

04) Press the **SETUP** button to set the speed of the selected built-in program.





05) Press the **UP/DOWN** buttons to adjust the speed. The adjustment range is between 0 and 100, from slow to fast.

06) Press the **SETUP** button to confirm the speed setting and to activate the program.

2. Art-Net

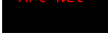
In this menu you can set Art-Net as communication protocol.

- 01) Press the **MODE** button to navigate through the Main Menu until the display shows .
- 02) Press the **SETUP** button to confirm the selection. The device will start receiving Art-Net data and the screen will show the following progress screen with dots: .

Note: If you select a DMX value on your lighting controller/computer, which has no function, the screen will show: .

Note: The Festoonlight Q4 Controller does not automatically detect whether Art-Net data signal is received or not. Select Art-Net on the Main Menu to start receiving data. **If you exit the Art-Net menu, the Art-Net connection will be terminated.**

3. DMX-IN

In this menu you can set DMX-512 as communication protocol.

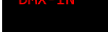
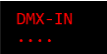
- 01) Press the **MODE** button to navigate through the Main Menu until the display shows .
- 02) Press the **SETUP** button to confirm the selection. The device will start receiving DMX data and the screen will show the following progress screen with dots: .



Note: If you select a DMX value on your lighting controller/computer, which has no function, the screen will show: .

Note: The Festoonlight Q4 Controller does not automatically detect whether DMX data signal is received or not. Select DMX-IN on the Main Menu to start receiving data. **If you exit the DMX-IN menu, the DMX connection will be terminated.**

4. Settings

In this menu you can adjust the device's settings.

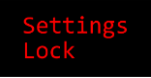
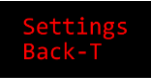
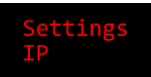
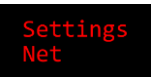
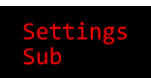
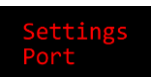
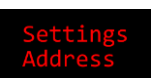
- 01) Press the **MODE** button to navigate through the Main Menu until the display shows .
- 02) Press the **SETUP** button to confirm the selection.
- 03) Press the **UP/DOWN** buttons to scroll through the following submenus:

	See 4.1. Lock Screen.
	Display backlight settings: Select DISABLE to have the display backlight always on or select the amount of time (1–60 minutes), after which the backlight will turn off.
	See 4.2. IP Address.
	Art-Net settings – Net value: The adjustment range is between 0–127. The net is 14–8 bits. See Art-Net Settings on page 14 for more information.
	Art-Net settings – Sub-Net value: The adjustment range is between 0–15. The Sub-Net is 7–4 bits. See Art-Net Settings on page 14 for more information.
	Art-Net settings – Port value: The adjustment ranges is between 0–15. The Port is 3–0 bits. See Art-Net Settings on page 14 for more information.
	DMX addressing: Set the starting DMX address of the device. The adjustment range is between 0 and 512.
	See 4.3. Channel Modes.

Settings
Default

See **4.4. Factory Default**.

- 04) Press the **SETUP** button to enter the submenus.
- 05) Press the **UP/DOWN** buttons to select the values.
- 06) Press the **SETUP** button to confirm the selection.

4.1. Lock Screen

In this submenu you can activate the display lock.

- 01) Press the **UP/DOWN** buttons to toggle between NO and YES.

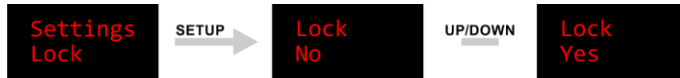

- NO: the Main Menu remains unlocked after the display turns off.
 - YES: display lock is activated. By default the display turns off after 60 seconds of inactivity. To access the Main Menu, you will need to enter the password. The default password is pressing the **MODE** and **SETUP** buttons at the same.
- 02) Press the **SETUP** button to confirm your choice.

4.2. IP Address

In this submenu you can configure manually the IP address of the device.

- 01) Press the **SETUP** button to move the cursor to the right on the display. A dot will appear after the selected number:



- 02) Press the **UP/DOWN** buttons to change the number. The selection range is between 0 and 255.
- 03) Press the **SETUP** button to confirm and to move to the next number.
- 04) Repeat steps 2–3 for each of the 4 sections of the IP address.

4.3. Channel Modes

In this submenu you can set the DMX Channel Mode.

- 01) Press the **UP/DOWN** buttons to select the desired DMX channel mode. There are 6 options available:

Ch-Mode 4ChBasic	4ChBasic – 4 channels (Basic)
Ch-Mode 4ChRGBW	4ChRGBW – 4 channels (RGBW)
Ch-Mode 8Ch O/E	8Ch O/E – 8 channels (Odd/Even)
Ch-Mode 8ChParty	8ChParty – 8 channels (Party)
Ch-Mode 20Ch Pix	20Ch Pix – 80 channels (20 Pixel) – Individual control of each LED bulb (1 Festoonlight Q4 String)
Ch-Mode Full Pix	Full Pix – 480 channels (Full Pixel) – Individual control of each LED bulb (2–6 Festoonlight Q4 Strings)

- 02) Press the **SETUP** button to confirm your choice. See pages 24–27 for the DMX Channel Modes.

4.4. Factory Default

In this submenu you can restore the default factory settings.

Press the **SETUP** button to confirm the prompt on the screen: Default Yes?. After completion of the reset, the

screen will show Default Done.

5. Info

In this menu you can view the current firmware version of the device.

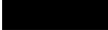
- 01) Press the **MODE** button to navigate through the Main Menu until the display shows .
- 02) Press the **SETUP** button to confirm the selection. The display will show the current firmware version.

6. Lamp Test

In this menu you can perform lamp test.

- 01) Press the **MODE** button to navigate through the Main Menu until the display shows .
- 02) Press the **SETUP** button to confirm the selection.
- 03) Press the **UP/DOWN** buttons to choose one the following options:

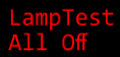

All off – when selected, all LEDs on the connected Festoonlight Strings turn off.



Red – when selected, all LEDs on the connected Festoonlight Strings light in red.



Green – when selected, all LEDs on the connected Festoonlight Strings light in green.



Blue – when selected, all LEDs on the connected Festoonlight Strings light in blue.



White – when selected, all LEDs on the connected Festoonlight Strings light in white.

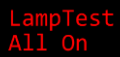

All on – when selected, all LEDs on the connected Festoonlight Strings turn on.

- 04) Press the **SETUP** button to confirm the selection and run the test.

DMX Channels

4 channels (Basic)

Channel 1 – Master Dimmer

0–255 Gradual adjustment of the brightness, from low to high intensity (0–100 %)

Channel 2 – Linear Strobe

0–15	No strobe
16–31	Strobe flash rate 1 Hz (1000 ms)
32–47	Strobe flash rate 1,5 Hz (675 ms)
48–63	Strobe flash rate 2 Hz (500 ms)
64–79	Strobe flash rate 2,5 Hz (400 ms)
80–95	Strobe flash rate 3 Hz (325 ms)
96–111	Strobe flash rate 3,6 Hz (275 ms)
112–127	Strobe flash rate 4 Hz (250 ms)
128–143	Strobe flash rate 4,4 Hz (225 ms)
144–159	Strobe flash rate 5 Hz (200 ms)
160–175	Strobe flash rate 5,7 Hz (175 ms)
176–191	Strobe flash rate 6,6 Hz (150 ms)
192–207	Strobe flash rate 8 Hz (125 ms)
208–223	Strobe flash rate 10 Hz (100 ms)
224–239	Strobe flash rate 13,3 Hz (75 ms)
240–255	Strobe flash rate 20 Hz (50 ms)

Channel 3 – Built-in Programs CH1 must be open

0	No function
1–1	Program 1
2–2	Program 2
3–3	Program 3
4–4	Program 4
5–5	Program 5
6–6	Program 6
7–7	Program 7
8–8	Program 8
9–9	Program 9
10–10	Program 10
11–11	Program 11
12–12	Program 12
13–13	Program 13
14–14	Program 14
15–15	Program 15
16–16	Program 16
17–17	Program 17
18–18	Program 18
19–19	Program 19
20–20	Program 20
21–21	Program 21
22–22	Program 22
23–23	Program 23
24–24	Program 24
25–25	Program 25
26–26	Program 26
27–27	Program 27
28–28	Program 28
29–29	Program 29
30–30	Program 30

31–255 No function

Channel 4 – Built-in Programs Speed

0–255 Speed adjustment, from slow to fast

4 channels (RGBW)

Channel 1 – All LEDs Red

0–255 Gradual adjustment of the brightness, from low to high intensity (0–100 %)

Channel 2 – All LEDs Green

0–255 Gradual adjustment of the brightness, from low to high intensity (0–100 %)

Channel 3 – All LEDs Blue

0–255 Gradual adjustment of the brightness, from low to high intensity (0–100 %)

Channel 4 – All LEDs White

0–255 Gradual adjustment of the brightness, from low to high intensity (0–100 %)

8 channels (Odd/Even)



Channel 1 – Odd LEDs Red

0–255 Gradual adjustment of the brightness, from low to high intensity (0–100 %)

Channel 2 – Odd LEDs Green

0–255 Gradual adjustment of the brightness, from low to high intensity (0–100 %)

Channel 3 – Odd LEDs Blue

0–255 Gradual adjustment of the brightness, from low to high intensity (0–100 %)

Channel 4 – Odd LEDs White

0–255 Gradual adjustment of the brightness, from low to high intensity (0–100 %)

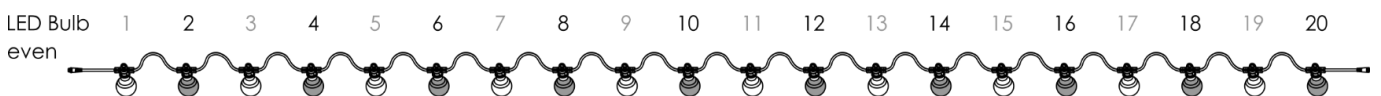

Channel 5 – Even LEDs Red

0–255 Gradual adjustment of the brightness, from low to high intensity (0–100 %)

Channel 6 – Even LEDs Green

0–255 Gradual adjustment of the brightness, from low to high intensity (0–100 %)

Channel 7 – Even LEDs Blue

0–255 Gradual adjustment of the brightness, from low to high intensity (0–100 %)

Channel 8 – Even LEDs White

0–255 Gradual adjustment of the brightness, from low to high intensity (0–100 %)

8 channels (Party)

Channel 1 – Master Dimmer

0–255 Gradual adjustment of the brightness, from low to high intensity (0–100 %)

Channel 2 – Linear Strobe

0–15	No strobe
16–31	Strobe flash rate 1 Hz (1000 ms)
32–47	Strobe flash rate 1,5 Hz (675 ms)
48–63	Strobe flash rate 2 Hz (500 ms)
64–79	Strobe flash rate 2,5 Hz (400 ms)
80–95	Strobe flash rate 3 Hz (325 ms)
96–111	Strobe flash rate 3,6 Hz (275 ms)
112–127	Strobe flash rate 4 Hz (250 ms)
128–143	Strobe flash rate 4,4 Hz (225 ms)
144–159	Strobe flash rate 5 Hz (200 ms)
160–175	Strobe flash rate 5,7 Hz (175 ms)
176–191	Strobe flash rate 6,6 Hz (150 ms)
192–207	Strobe flash rate 8 Hz (125 ms)
208–223	Strobe flash rate 10 Hz (100 ms)
224–239	Strobe flash rate 13,3 Hz (75 ms)
240–255	Strobe flash rate 20 Hz (50 ms)

Channel 3 – All LEDs Red ⚠ CH1 must be open ⚠

0–255 Gradual adjustment of the brightness, from low to high intensity (0–100 %)

Channel 4 – All LEDs Green ⚠ CH1 must be open ⚠

0–255 Gradual adjustment of the brightness, from low to high intensity (0–100 %)

Channel 5 – All LEDs Blue ⚠ CH1 must be open ⚠

0–255 Gradual adjustment of the brightness, from low to high intensity (0–100 %)

Channel 6 – All LEDs White ⚠ CH1 must be open ⚠

0–255 Gradual adjustment of the brightness, from low to high intensity (0–100 %)

Channel 7 – Built-in Programs ⚠ CH1 must be open ⚠

0	No function
1–1	Program 1
2–2	Program 2
3–3	Program 3
4–4	Program 4
5–5	Program 5
6–6	Program 6
7–7	Program 7
8–8	Program 8
9–9	Program 9
10–10	Program 10
11–11	Program 11
12–12	Program 12
13–13	Program 13
14–14	Program 14
15–15	Program 15
16–16	Program 16
17–17	Program 17
18–18	Program 18
19–19	Program 19

20-20	Program 20
21-21	Program 21
22-22	Program 22
23-23	Program 23
24-24	Program 24
25-25	Program 25
26-26	Program 26
27-27	Program 27
28-28	Program 28
29-29	Program 29
30-30	Program 30
31-255	No function

Channel 8 – Built-in Programs Speed

0-255	Speed adjustment, from slow to fast
-------	-------------------------------------

80 channels (20 Pixel)

In this mode each LED bulb of the Festoonlight Q4 String can be controlled individually. There are 20 LED bulbs in one string.

Channel 1 – LED Bulb 1 – Red

0-255	Gradual adjustment of the brightness, from low to high intensity (0-100 %)
-------	--

Channel 2 – LED Bulb 1 – Green

0-255	Gradual adjustment of the brightness, from low to high intensity (0-100 %)
-------	--

Channel 3 – LED Bulb 1 – Blue

0-255	Gradual adjustment of the brightness, from low to high intensity (0-100 %)
-------	--

Channel 4 – LED Bulb 1 – White

0-255	Gradual adjustment of the brightness, from low to high intensity (0-100 %)
-------	--

...

Channel 80 – LED Bulb 20 – White

0-255	Gradual adjustment of the brightness, from low to high intensity (0-100 %)
-------	--

LED Bulb	1	2	3	4	5	6	7	8	9	10	11	12	13	14	15	16	17	18	19	20
Red	1	5	9	13	17	21	25	29	33	37	41	45	49	53	57	61	65	69	73	77
Green	2	6	10	14	18	22	26	30	34	38	42	46	50	54	58	62	66	70	74	78
Blue	3	7	11	15	19	23	27	31	35	39	43	47	51	55	59	63	67	71	75	79
White	4	8	12	16	20	24	28	32	36	40	44	48	52	56	60	64	68	72	76	80

480 channels (Full Pixel)

In this mode each LED bulb for setups with 2-6 Festoonlight Q4 Strings can be controlled individually.

Note: To connect more than 3 Festoonlight Q4 Strings to the controller, you will need the Festoonlight Q4 Booster.

Channel 1 – String 1 LED Bulb 1 – Red

0-255	Gradual adjustment of the brightness, from low to high intensity (0-100 %)
-------	--

Channel 2 – String 1 LED Bulb 1 – Green

0-255	Gradual adjustment of the brightness, from low to high intensity (0-100 %)
-------	--

Channel 3 – String 1 LED Bulb 1 – Blue

0–255 Gradual adjustment of the brightness, from low to high intensity (0–100 %)

Channel 4 – String 1 LED Bulb 1 – White

0–255 Gradual adjustment of the brightness, from low to high intensity (0–100 %)

...

Channel 480 – String 6 LED Bulb 20 – White

0–255 Gradual adjustment of the brightness, from low to high intensity (0–100 %)

LED Bulb	1	2	3	4	5	6	7	8	9	10	11	12	13	14	15	16	17	18	19	20
String 1																				
Red	1	5	9	13	17	21	25	29	33	37	41	45	49	53	57	61	65	69	73	77
Green	2	6	10	14	18	22	26	30	34	38	42	46	50	54	58	62	66	70	74	78
Blue	3	7	11	15	19	23	27	31	35	39	43	47	51	55	59	63	67	71	75	79
White	4	8	12	16	20	24	28	32	36	40	44	48	52	56	60	64	68	72	76	80

LED Bulb	1	2	3	4	5	6	7	8	9	10	11	12	13	14	15	16	17	18	19	20
String 2																				
Red	81	85	89	93	97	101	105	109	113	117	121	125	129	133	137	141	145	149	153	157
Green	82	86	90	94	98	102	106	110	114	118	122	126	130	134	138	142	146	150	154	158
Blue	83	87	91	95	99	103	107	111	115	119	123	127	131	135	139	143	147	151	155	159
White	84	88	92	96	100	104	108	112	116	120	124	128	132	136	140	144	148	152	156	160

LED Bulb	1	2	3	4	5	6	7	8	9	10	11	12	13	14	15	16	17	18	19	20
String 3																				
Red	161	165	169	173	177	181	185	189	193	197	201	205	209	213	217	221	225	229	233	237
Green	162	166	170	174	178	182	186	190	194	198	202	206	210	214	218	222	226	230	234	238
Blue	163	167	171	175	179	183	187	191	195	199	203	207	211	215	219	223	227	231	235	239
White	164	168	172	176	180	184	188	192	196	200	204	208	212	216	220	224	228	232	236	240

LED Bulb	1	2	3	4	5	6	7	8	9	10	11	12	13	14	15	16	17	18	19	20
String 4																				
Red	241	245	249	253	257	261	265	269	273	277	281	285	289	293	297	301	305	309	313	317
Green	242	246	250	254	258	262	266	270	274	278	282	286	290	294	298	302	306	310	314	318
Blue	243	247	251	255	259	263	267	271	275	279	283	287	291	295	299	303	307	311	315	319
White	244	248	252	256	260	264	268	272	276	280	284	288	292	296	300	304	308	312	316	320

LED Bulb	1	2	3	4	5	6	7	8	9	10	11	12	13	14	15	16	17	18	19	20
String 5																				
Red	321	325	329	333	337	341	345	349	353	357	361	365	369	373	377	381	385	389	393	397
Green	322	326	330	334	338	342	346	350	354	358	362	366	370	374	378	382	386	390	394	398
Blue	323	327	331	335	339	343	347	351	355	359	363	367	371	375	379	383	387	391	395	399
White	324	328	332	336	340	344	348	352	356	360	364	368	372	376	380	384	388	392	396	400

LED Bulb	1	2	3	4	5	6	7	8	9	10	11	12	13	14	15	16	17	18	19	20
String 6																				
Red	401	405	409	413	417	421	425	429	433	437	441	445	449	453	457	461	465	469	473	477
Green	402	406	410	414	418	422	426	430	434	438	442	446	450	454	458	462	466	470	474	478
Blue	403	407	411	415	419	423	427	431	435	439	443	447	451	455	459	463	467	471	475	479
White	404	408	412	416	420	424	428	432	436	440	444	448	452	456	460	464	468	472	476	480

Maintenance

The operator has to make sure that safety-related and machine-technical installations are to be inspected by an expert after every year in the course of an acceptance test.

The operator has to make sure that safety-related and machine-technical installations are to be inspected by a skilled person once a year.

The following points have to be considered during the inspection:

- 01) All screws used for installing the device or parts of the device have to be tightly connected and must not be corroded.
- 02) There may not be any deformations on housings, fixations and installation spots.
- 03) The electric power supply cables must not show any damages or material fatigue.

The Festoonlight Q4 Controller requires almost no maintenance. However, you should keep the unit clean. Disconnect the mains power supply, and then wipe the housing with a damp cloth. Do not immerse in liquid. Do not use alcohol or solvents.

Keep connections clean. Disconnect electric power, and then wipe the DMX connections with a damp cloth. Make sure connections are thoroughly dry before linking equipment or supplying electric power.

Replacing the Fuse

Power surges, short-circuit or inappropriate electrical power supply may cause a fuse to burn out. If the fuse burns out, the product will not function whatsoever. If this happens, follow the directions below to do so.

- 01) Unplug the unit from electric power source.
- 02) Insert a screwdriver into the slot in the fuse cover. Turn the fuse holder counterclockwise. The fuse will come out.
- 03) Remove the used fuse. If brown or unclear, it is burned out.
- 04) Insert the replacement fuse into the holder where the old fuse was. Reinsert the fuse holder. Be sure to use a fuse of the same type and specification. See the product specification label for details.

Troubleshooting

This troubleshooting guide is meant to help solve simple problems.

If a problem occurs, carry out the steps below in sequence until a solution is found. Once the unit operates properly, do not carry out following steps.

No Light

If the LED string does not operate properly, refer servicing to a technician.

Suspect four potential problem areas as: the power supply, the fuse, the controller and the LEDs.

- 01) Power supply. Check that the unit is plugged into an appropriate power supply.
- 02) The fuse. Replace the fuse. See page 28 for replacing the fuse.
- 03) The controller. Return the controller to your Showtec dealer.
- 04) The LEDs. Return the LED string to your Showtec dealer.
- 05) If all of the above appears to be O.K., plug the unit in again.
- 06) If you are unable to determine the cause of the problem, do not open the controller, as this may damage the unit and the warranty will become void.
- 07) Return the device to your Showtec dealer.

No Response to DMX

Suspect the DMX cable or connectors or a controller malfunction.

- 01) Check the DMX settings. Make sure that DMX addresses are correct.
- 02) Check the DMX cable: Unplug the unit; change the DMX cable; then reconnect to electrical power. Try your DMX control again.

Problem	Probable cause(s)	Solution
One or more fixtures do not function at all	No power to the fixture	<ul style="list-style-type: none"> • Check if power is switched on and cables are plugged in
	Primary fuse blown	<ul style="list-style-type: none"> • Replace fuse
Fixtures reset correctly, but all respond erratically or not at all to the lighting controller	The lighting controller is not connected	<ul style="list-style-type: none"> • Connect lighting controller
	3-pin DMX OUT of the lighting controller does not match DMX IN of the first fixture on the link (i.e. signal is reversed)	<ul style="list-style-type: none"> • Install a phase reversing cable between the lighting controller and the first fixture on the link
Fixtures reset correctly, but some respond erratically or not at all to the lighting controller	Poor data quality	<ul style="list-style-type: none"> • Check data quality. If much lower than 100 percent, the problem may be a bad data link connection, poor quality or broken cables, missing termination plug, or a defective fixture disturbing the link
	Bad data link connection	<ul style="list-style-type: none"> • Inspect connections and cables. Correct poor connections. Repair or replace damaged cables
	Data link not terminated with 120 Ohm termination plug	<ul style="list-style-type: none"> • Insert termination plug in output jack of the last fixture on the link
	Incorrect addressing of the fixtures	<ul style="list-style-type: none"> • Check address settings
	One of the fixtures is defective and disturbs data transmission on the link	<ul style="list-style-type: none"> • Bypass one fixture at a time until normal operation is regained: unplug both connectors and connect them directly together • Have the defective fixture serviced by a qualified technician
	3-pin DMX OUT on the fixtures does not match (pins 2 and 3 reversed)	<ul style="list-style-type: none"> • Install a phase-reversing cable between the fixtures or swap pin 2 and 3 in the fixture, that behaves erratically
No light or LEDs cut out intermittently	Fixture is too hot	<ul style="list-style-type: none"> • Make sure air vents are not blocked
	LEDs damaged	<ul style="list-style-type: none"> • Disconnect fixture and return to your dealer
	The power supply settings do not match local AC voltage and frequency	<ul style="list-style-type: none"> • Disconnect fixture. Check settings and correct if necessary

Product Specifications

Model:	Showtec Festoonlight Q4 Controller
Power input:	100–240 V AC, 50/60 Hz
Power consumption:	110 W (max at full output)
Dimensions:	315 x 200 x 93 mm (L x W x H)
Weight:	2,3 kg (without mounting bracket)
Signal pin OUT:	pin 1 earth, pin 2 (-), pin 3 (+)
Signal output:	3-pin DMX signal connector OUT
Maximum number of strings:	3 without a booster (6 with a booster)
Maximum length:	90 m
Control protocol:	DMX-512, Art-Net
Control modes:	Built-in programs, DMX/Art-Net
DMX channels:	Basic (4 channels), RGBW (4 channels), Odd/Even (8 channels), Party (8 channels), 20 Pixel (80 channels), Full Pixel (480 channels)
Connections:	Pro power connectors IN/OUT, 3-pin DMX connectors IN/OUT, RJ45 connectors IN/OUT, dedicated Festoonlight Q4 String connector
Cooling:	Convection
IP rating:	IP20
Fuse:	T2 A/250 V
Strings:	Not included
Booster:	Not included
Extension cord:	1 x 10 m (maximum 1 extension cord per Festoonlight Q4 Controller)
Max. ambient temperature t_a :	40 °C

Design and product specifications are subject to change without prior notice.



Website: www.Showtec.info

Email: service@highlite.com

Dimensions

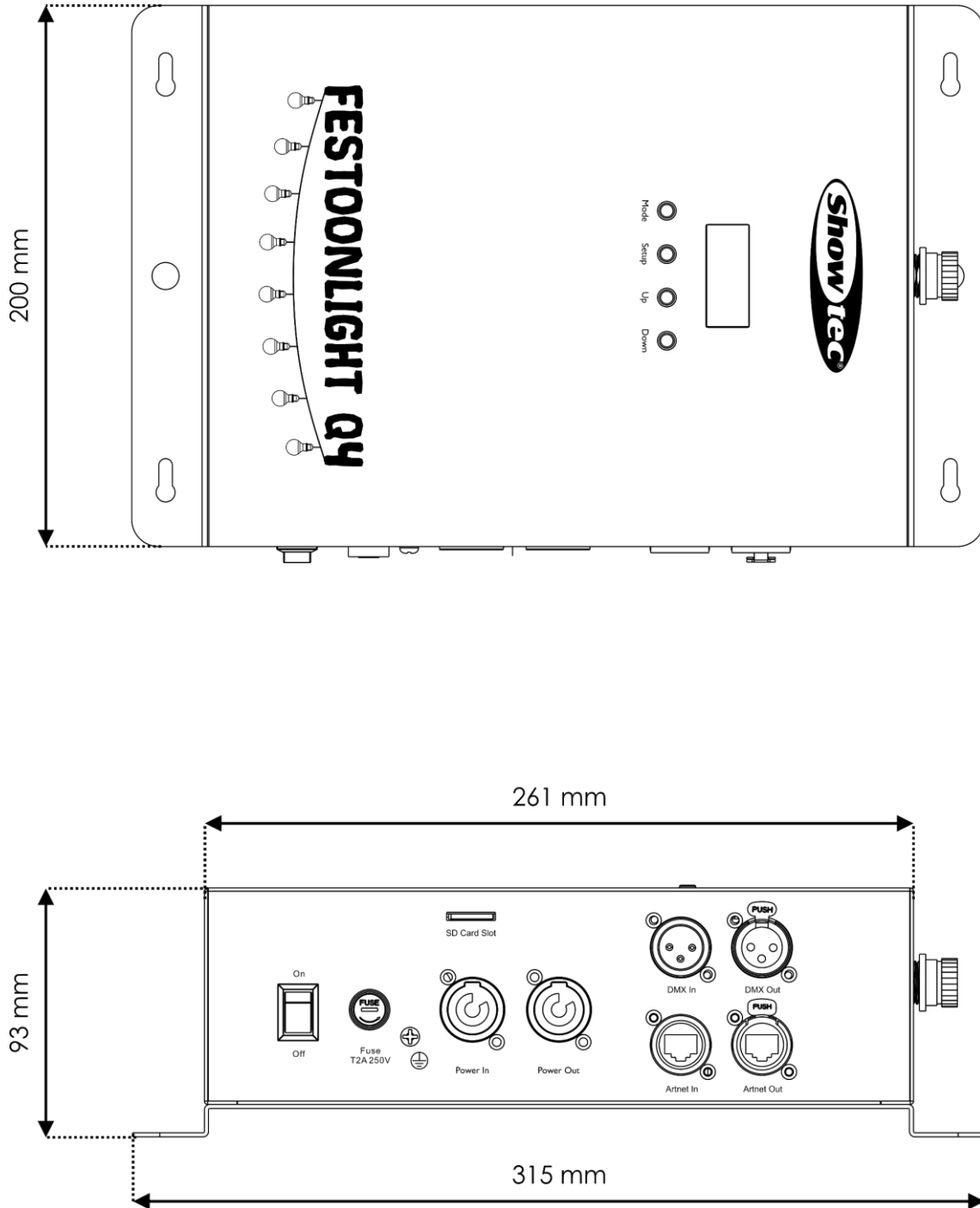



©2019 Showtec