

ENGLISH

Infinity iW-1915 Pixel

V4

Ordercode: 41523

Table of contents

Warning	2
Safety Instructions	2
Operating Determinations	4
Rigging	4
Connection with the mains.....	5
Return Procedure.....	6
Claims.....	6
Description of the device	7
Frontside.....	8
Backside	9
Installation	9
Set Up and Operation	9
Control Modes.....	10
One Infinity (Stand-alone).....	10
Multiple Infinities (Master/Slave control).....	10
Multiple Infinities (DMX control).....	11
Multiple Infinities (ArtNet control).....	12
Fixture Linking.....	13
Data Cabling.....	13
Control Panel.....	14
Control Mode	14
DMX Addressing.....	14
Menu Overview.....	15
Main Menu Options.....	17
1. DMX Addressing.....	17
1.1. DMX settings	17
1.2. ArtNet settings (ArtNet + DMX mode)	18
2. Edit Mode.....	18
3. Settings Menu.....	19
3.1. Color Balance	19
3.2. Life Time.....	20
3.2.1. Set Password	20
3.2.2. Network Setting	20
3.3. Reset	21
4. Built-in Programs.....	21
5. Test Menu	22
6. System information.....	23
DMX Channels.....	23
21 channels.....	23
97 channels.....	27
76+14 channels (ArtNet + DMX mode).....	33
Channel Settings.....	36
Connecting to a Network	37
ArtNet settings	37
How to make a data cable.....	37
Maintenance	38
Replacing the Fuse.....	38
Troubleshooting	38
No Light.....	38
No Response to DMX.....	39
Product Specifications	40
Dimensions	41

Warning



**For your own safety, please read this user manual carefully
before your initial start-up!**



Unpacking Instructions

Immediately upon receiving this product, carefully unpack the carton and check the contents to ensure that all parts are present, and have been received in good condition. Notify the dealer immediately and retain packing material for inspection if any parts appear damaged from shipping or the carton itself shows signs of mishandling. Save the carton and all packing materials. In the event that a fixture must be returned to the factory, it is important that the fixture be returned in the original factory box and packing.

Your shipment includes:

- Infinity iW-1915 Pixel
- 2 x mounting bracket with quick-locks
- Neutrik PowerCON to Schuko power cable 1,5 m
- User manual

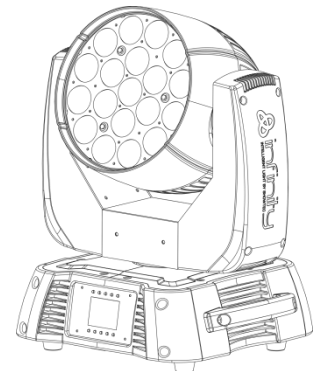
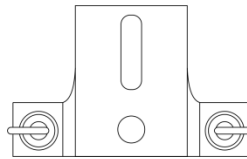

LED Expected Lifespan

LEDs gradually decline in brightness over time. HEAT is the dominant factor that leads to the acceleration of this decline. Packaged in clusters, LEDs exhibit higher operating temperatures than in ideal or singular optimum conditions. For this reason, when all color LEDs are used at their fullest intensity, life of the LEDs is significantly reduced. If improving life expectancy is of higher priority, place care in providing for lower operational temperatures. This may include climatic-environmental and the reduction of overall projection intensity.



CAUTION!

**Keep this device away from rain and moisture!
Unplug mains lead before opening the housing!**



Safety Instructions

Every person involved with the installation, operation and maintenance of this device has to:

- be qualified
- follow the instructions of this manual



**CAUTION! Be careful with your operations.
With a dangerous voltage you can suffer
a dangerous electric shock when touching the wires!**



Before the initial start-up, please make sure that there is no damage caused by transportation. Should there be any, consult your dealer and do not use the device.

To maintain perfect condition and to ensure a safe operation, it is absolutely necessary for the user to follow the safety instructions and warning notes written in this manual.

Please consider that damages caused by manual modifications to the device are not subject to warranty.

This device contains no user-serviceable parts. Refer servicing to qualified technicians only.

IMPORTANT:

The manufacturer will not accept liability for any resulting damages caused by the non-observance of this manual or any unauthorized modification to the device.

- Never let the power cord come into contact with other cables! Handle the power cord and all connections with the mains with particular caution!
- Never remove warning or informative labels from the unit.
- Never use anything to cover the ground contact.
- Never lift the fixture holding it by the projector-head, as the mechanics may be damaged. Always hold the fixture by the transport handles.
- Never place any material over the lens.
- Never look directly into the light source.
- Never leave any cables lying around.
- Do not insert objects into air vents.
- Do not connect this device to a dimmer pack.
- Do not switch the device on and off in short intervals, as this will reduce the device's life.
- Do not touch the device's housing bare-handed during its operation (housing becomes very hot). Allow the fixture to cool for at least 5 minutes before handling.
- Do not shake the device. Avoid brute force when installing or operating the device.
- Only use the device indoors, avoid contact with water or other liquids.
- Only operate the fixture after having checked if the housing is firmly closed and all screws are tightly fastened.
- Only operate the device after having familiarized with its functions.
- Avoid flames and do not put close to flammable liquids or gases.
- Always keep the case closed while operating.
- Always allow a free air space of at least 50 cm around the unit for ventilation.
- Always disconnect power from the mains, when device is not used or before cleaning! Only handle the power cord holding it by the plug. Never pull out the plug by tugging the power cord.
- Make sure that the device is not exposed to extreme heat, moisture or dust.
- Make sure that the available voltage is not higher than stated on the rear panel.
- Make sure that the power cord is never crimped or damaged. Check the device and the power cord from time to time.
- If the lens is obviously damaged, it has to be replaced.
- If device was dropped or struck, disconnect mains power supply immediately. Have a qualified engineer inspect for safety before operating.
- If the device has been exposed to drastic temperature fluctuation (e.g. after transportation), do not switch it on immediately. The arising condensation water might damage your device. Leave the device switched off until it has reached room temperature.
- If your Infinity device fails to work properly, discontinue the use immediately. Pack the unit securely (preferably in the original packing material), and return it to your Infinity dealer for service.
- For adult use only. The moving head must be installed beyond the reach of children. Never leave the unit running unattended.
- Never attempt to bypass the thermostatic switch or fuses.
- For replacement use fuses of same type and rating only.
- The user is responsible for correct positioning and operating of the Infinity. The manufacturer will not accept liability for damages caused by the misuse or incorrect installation of this device.
- This device falls under protection class I. Therefore it is essential to connect the yellow/green conductor to earth.
- Repairs, servicing and electric connection must be carried out by a qualified technician.
- **WARRANTY:** Till one year after date of purchase.



CAUTION! Eyedamages!!!
Avoid looking directly into the lightsource!!!
(meant especially for epileptics)!!!



Operating Determinations

- This device is not designed for permanent operation. Consistent operation breaks will ensure that the device will serve you for a long time without defects.
- The minimum distance between light output and the illuminated surface must be bigger than 1,5 meter.
- To eliminate wear and improve lifespan, during periods of non-use, completely disconnect from power via breaker or by unplugging.
- The maximum ambient temperature $t_a = 40^\circ\text{C}$ must never be exceeded.
- The relative humidity must not exceed 50 % with an ambient temperature of 40°C .
- If this device is operated in any other way than the one described in this manual, the product may suffer damages and the warranty becomes void.
- Any other operation may lead to dangers like short-circuit, burns, electric shock, crash etc.

You endanger your own safety and the safety of others!

Rigging

Please follow the European and national guidelines concerning rigging, trussing and all other safety issues.

Do not attempt the installation yourself!

Always have the inspections carried out by an authorized dealer!

Procedure:

- If the Infinity is lowered from the ceiling or high joists, professional trussing systems have to be used.
- Use a clamp to mount the Infinity, with the mounting bracket, to the trussing system.
- The Infinity must never be fixed swinging freely in the room.
- The installation must always be secured with a safety attachment, e.g. an appropriate safety net or safety cable.
- When rigging, derigging or servicing the Infinity, always make sure, that the area below the installation site is secured and that there are not any unauthorized people around.

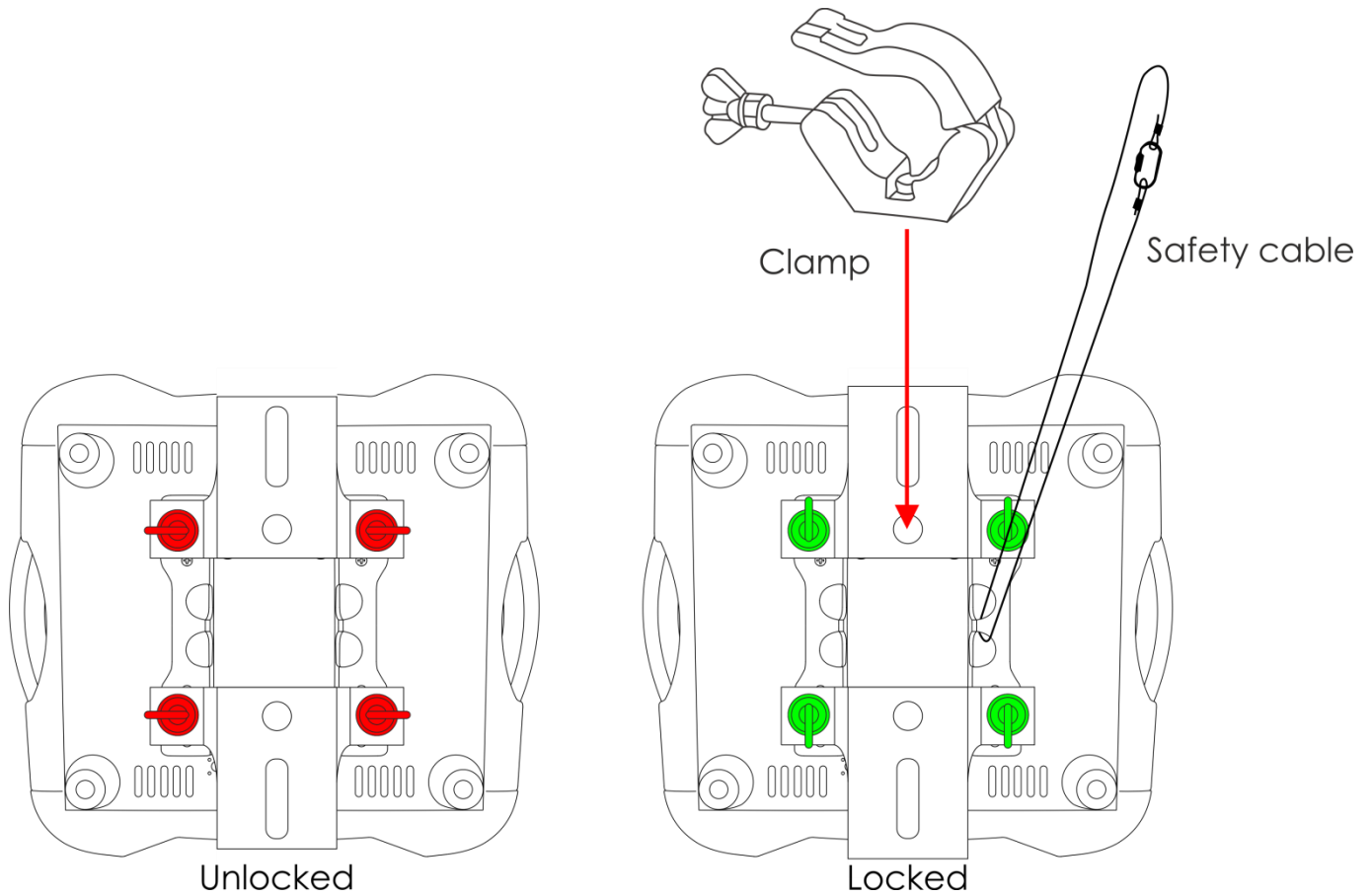

The Infinity can be placed on a flat stage floor or mounted to any kind of truss with a mounting bracket and a clamp.

Improper installation can cause serious injuries and/or damage of property!

Connection with the mains

Connect the device to the mains with the power-plug.
Always check if the right color cable is connected to the right place.

International	EU Cable	UK Cable	US Cable	Pin
L	BROWN	RED	YELLOW/COPPER	PHASE
N	BLUE	BLACK	SILVER	NEUTRAL
⊕	YELLOW/GREEN	GREEN	GREEN	PROTECTIVE GROUND

Make sure that the device is always properly connected to the earth!

Improper installation can cause serious injuries and/or damage of property!



Return Procedure



Returned merchandise must be sent prepaid and in the original packing, call tags will not be issued. Package must be clearly labeled with a Return Authorization Number (RMA number). Products returned without an RMA number will be refused. Highlite will not accept the returned goods or any responsibility. Call Highlite 0031-455667723 or mail offersales@highlite.nl and request an RMA prior to shipping the fixture. Be prepared to provide the model number, serial number and a brief description of the cause for the return. Be sure to properly pack fixture, any shipping damage resulting from inadequate packaging is the customer's responsibility. Highlite reserves the right to use its own discretion to repair or replace product(s). As a suggestion, proper UPS packing or double-boxing is always a safe method to use.

Note: If you are given an RMA number, please include the following information on a piece of paper inside the box:

- 01) Your name
- 02) Your address
- 03) Your phone number
- 04) A brief description of the symptoms

Claims

The client has the obligation to check the delivered goods immediately upon delivery for any shortcomings and/or visible defects, or perform this check after our announcement that the goods are at their disposal. Damage incurred in shipping is the responsibility of the shipper; therefore the damage must be reported to the carrier upon receipt of merchandise.

It is the customer's responsibility to notify and submit claims with the shipper in the event that a fixture is damaged due to shipping. Transportation damage has to be reported to us within one day after receipt of the delivery.

Any return shipment has to be made post-paid at all times. Return shipments must be accompanied with a letter defining the reason for return shipment. Non-prepaid return shipments will be refused, unless otherwise agreed in writing.

Complaints against us must be made known in writing or by fax within 10 working days after receipt of the invoice. After this period complaints will not be handled anymore.

Complaints will only then be considered if the client has so far complied with all parts of the agreement, regardless of the agreement of which the obligation is resulting.

Description of the device

Features

The Infinity iW-1915 Pixel is a moving head effect with high output and great effects.

- Input voltage: 100-240V, 60/50Hz
- Power consumption: 675W
- DMX channels: 21, 97, 76+14 channels
- LCD display with gravity sensor
- Light source: 19 x 15W RGBW 4-in-1 Osram Ostar
- Lux @ 2m: 36600
- Color temperature: 19000K
- Control modes: Stand-alone, Master/Slave, DMX-512, DMX-512+ArtNet
- Control protocol: DMX-512, ArtNet
- Dimmer: 0-100%
- Strobe: 0-20Hz
- Dimming curves: Linear, Square, I-Square, S-curve
- Beam Angle: 7-50°
- Motorized Zoom: 7-50°
- Pan: 540°
- Tilt: 270°
- IP rating: IP20
- Housing: Metal & Flame retardant plastic
- Connections: Neutrik PowerCON & 3-pin/5-pin XLR IN/OUT, 2 x RJ45 ArtNet connector
- Fuse: F7AL/250V
- Dimensions: 355 x 300 x 455 mm (LxWxH)
- Weight: 14,28 kg

Optional accessories

[70450](#) – Saveking 3 mm

[70451](#) – Saveking 3 mm

[D7028](#) – Case for 2 x iW-1915

[D7238](#) – Case for 2 x iW-1915

[D7253](#) – Case for Infinity iB-2R/1915

[MOD41523](#) – Wireless DMX upgrade kit



**The Wireless DMX upgrade kit should be installed ONLY by a qualified technician.
Do not attempt installation yourself!**



Frontside

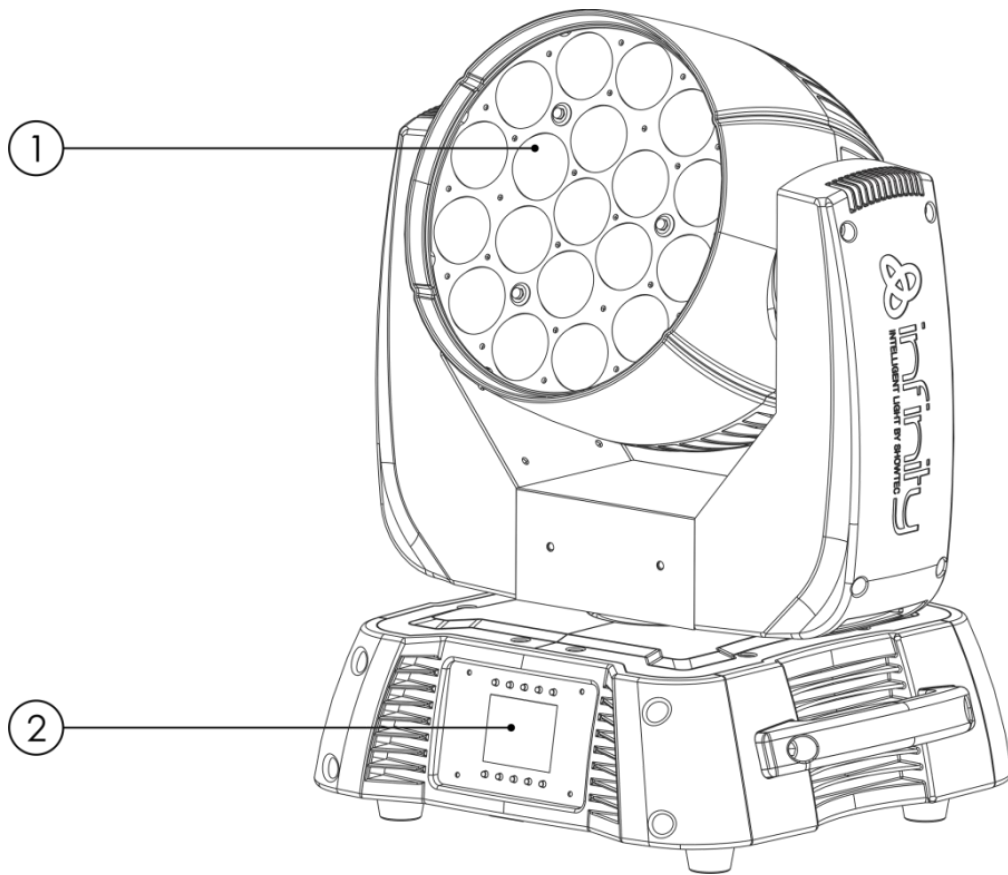

- 01) 19 x 15W RGBW 4-in-1 Osram Ostar
- 02) LCD display + menu buttons

Fig. 01

Backside

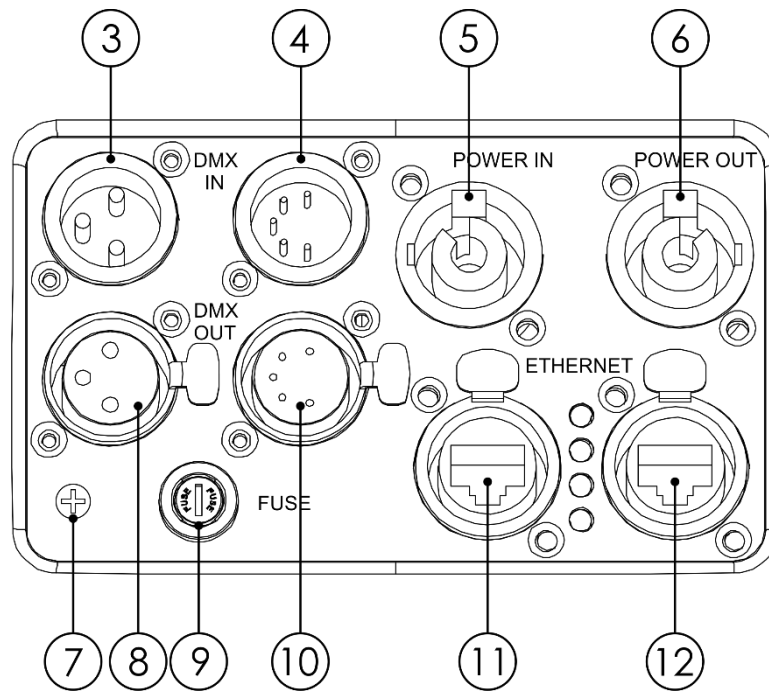

Fig. 02

- 03) 3-pin DMX signal connector IN
- 04) 5-pin DMX signal connector IN
- 05) PowerCON power connector 100-240V IN
- 06) PowerCON power connector 100-240V OUT
- 07) Ground/earth connection
- 08) 3-pin DMX signal connector OUT
- 09) Fuse F7AL/250V
- 10) 5-pin DMX signal connector OUT
- 11) RJ45 Ethernet connector
- 12) RJ45 Ethernet connector

Installation

Remove all packing materials from the Infinity iW-1915 Pixel. Check if all foam and plastic padding is removed. Connect all cables.

Do not supply power before the whole system is set up and connected properly.

Always disconnect from electric mains power supply before cleaning or servicing.

Damages caused by non-observance are not subject to warranty.

Set Up and Operation

Follow the directions below, as they pertain to your preferred operation mode.

Before plugging the unit in, always make sure that the power supply matches the product specification voltage. Do not attempt to operate a 120V specification product on 230V power, or vice versa.

Connect the device to the main power supply.

Control Modes

There are 4 modes:

- Stand-alone
- Master/Slave
- DMX-512 (21CH, 97CH)
- DMX-512+ArtNet (76+14CH)

One Infinity (Stand-alone)

- 01) Fasten the effect light to a firm trussing. Leave at least 0,5 meter on all sides for air circulation.
- 02) Plug the end of the electric mains power cord into a proper electric power supply socket.
- 03) When the Infinity is not connected with a DMX cable, it functions as a stand-alone device.
Please see pages 17-23 for more information about the Stand-alone Mode.

Multiple Infinities (Master/Slave control)

- 01) Fasten the effect light onto firm trussing. Leave at least 0,5 meter on all sides for air circulation.
- 02) Use a 3-pin/5-pin XLR cable to connect the Infinity.

The pins:



- 01) Earth
- 02) Signal -
- 03) Signal +

- 03) Link the units as shown in fig. 03. Connect the first unit's DMX "out" socket with the second unit's "in" socket, using a DMX-signal cable. Repeat this process to link the second, third, and fourth units. You can use the same functions on the master device as described on pages 17-23. This means that you can set your desired operation mode on the master device and all slave devices will react the same as the master device.

Multiple Infinities (Master/Slave control)

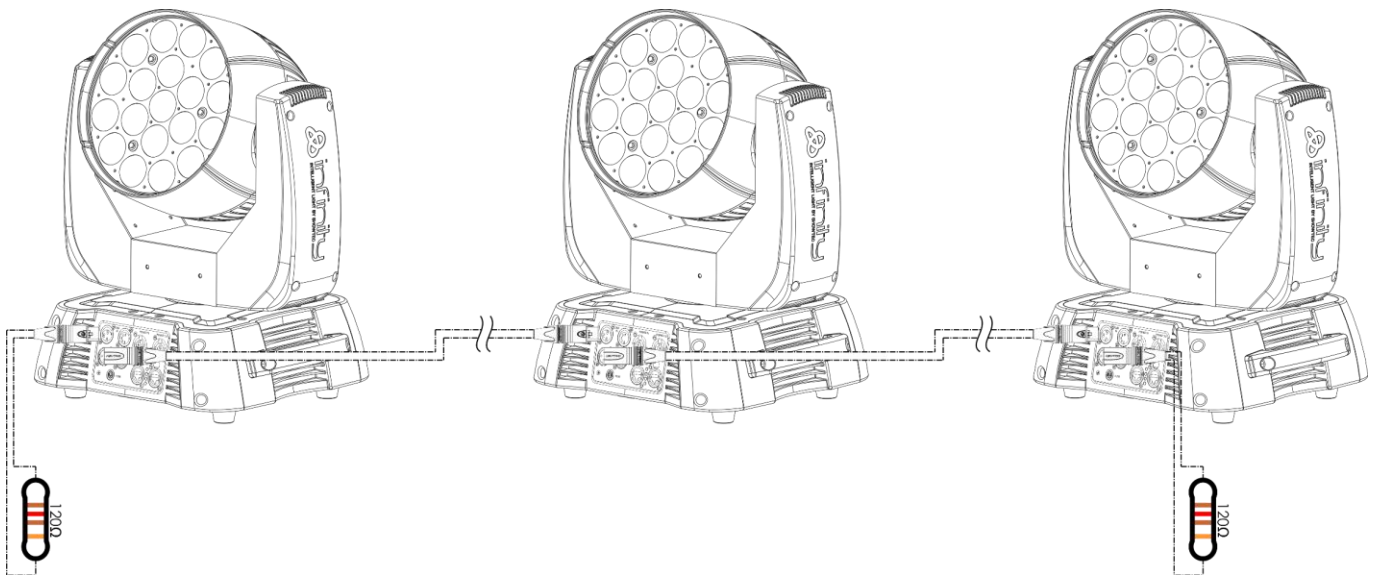
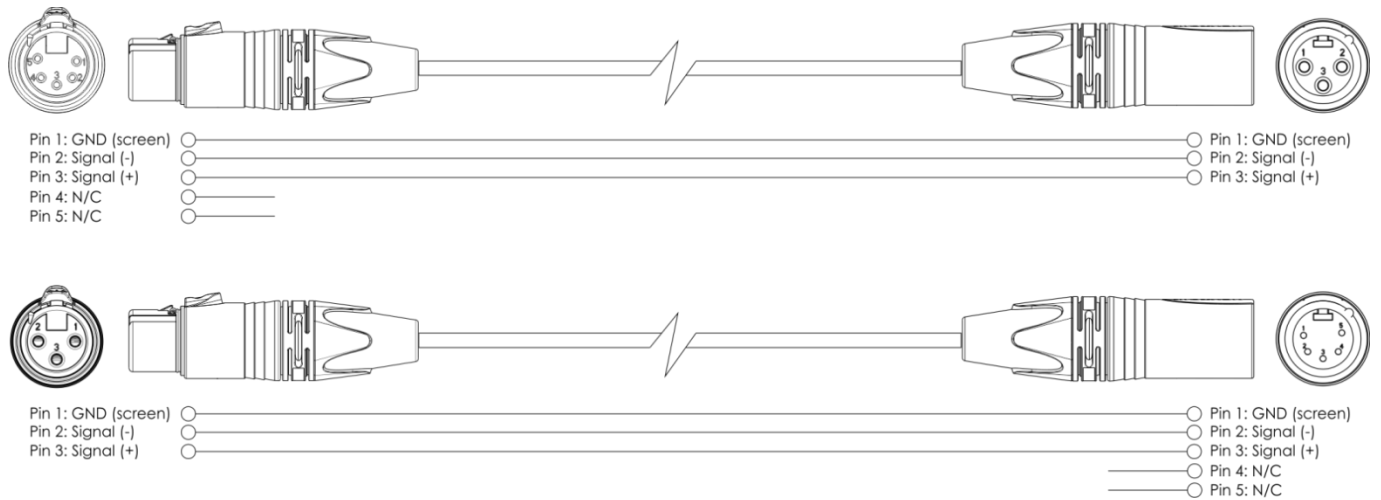

Fig. 03

Multiple Infinitys (DMX control)

- 01) Fasten the effect light to a firm trussing. Leave at least 0,5 meter on all sides for air circulation.
- 02) Always use a safety cable (ordercode 70140 / 70141).
- 03) Use a 3-pin/5-pin XLR cable to connect the Infinity and other devices.



- 04) Link the units as shown in fig. 04. Connect the first unit's DMX "out" socket with the second unit's "in" socket, using a DMX-signal cable. Repeat this process to link the second, third, and fourth units.
- 05) Supply electric power: Plug electric mains power cords into each unit's PowerCON socket, then plug the other end of the mains power cord into proper electric power supply sockets, starting with the first unit. Do not supply power before the whole system is set up and connected properly.

Multiple Infinitys DMX Set Up

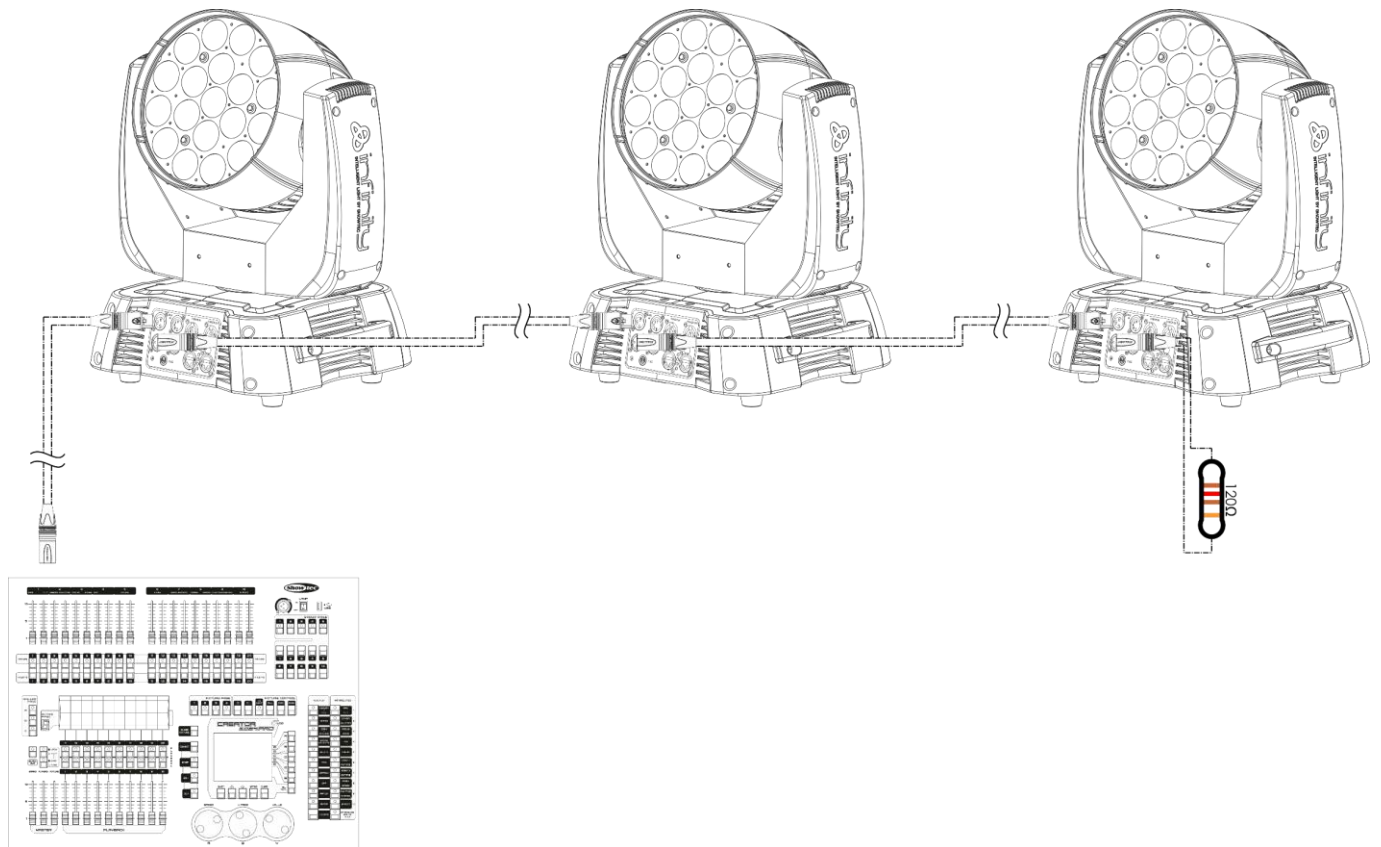

Fig. 04

Note : Link all cables before connecting electric power

Multiple Infinitys (ArtNet control)

- 01) Fasten the effect light to a firm trussing. Leave at least 0,5 meter on all sides for air circulation.
- 02) Always use a safety cable (ordercode 70140 / 70141).
- 03) Use a CAT-5/CAT-6 cable to connect the Infinity and other devices.
- 04) Connect your PC with installed ArtNet software to the first device's RJ45 "in" socket.
- 05) Link the units as shown in fig. 05. Connect the first unit's RJ45 "out" socket with the second unit's "in" socket, using a CAT-5/CAT-6 cable. Repeat this process to link the second, third, and fourth units.
- 06) Supply electric power: Plug electric mains power cords into each unit's PowerCON socket, then plug the other end of the mains power cord into proper electric power supply sockets, starting with the first unit. Do not supply power before the whole system is set up and connected properly.

Multiple Infinitys ArtNet Set Up

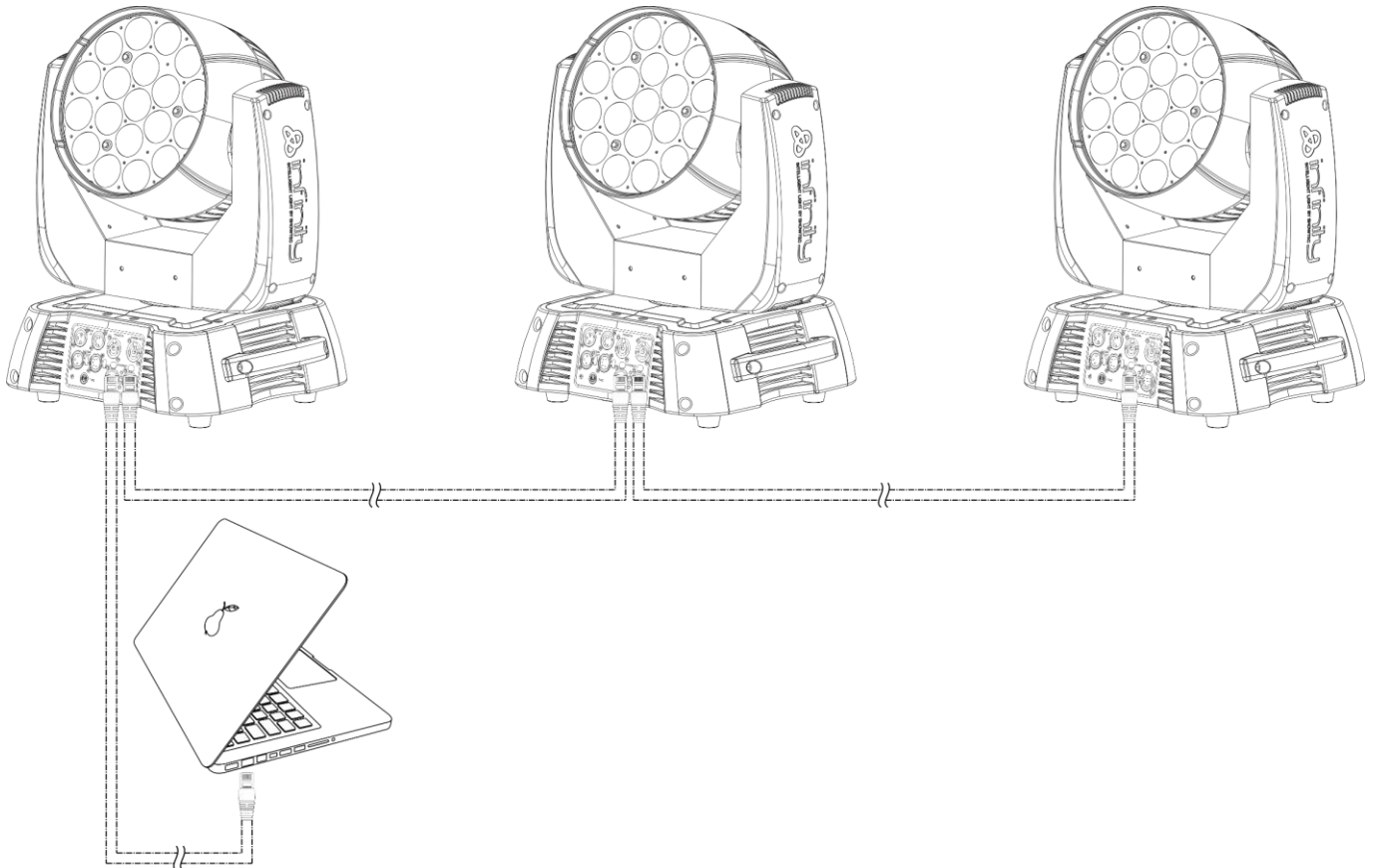



Fig. 05

Note : Link all cables before connecting electric power

Fixture Linking

You will need a serial data link to run light shows of one or more fixtures using a DMX-512 controller or to run synchronized shows of two or more fixtures set to a master/slave operating mode. The combined number of channels required by all the fixtures on a serial data link determines the number of fixtures the data link can support.

- Important:** Fixtures on a serial data link must be daisy-chained in a single line. To comply with the EIA-485 standard, no more than 30 devices should be connected on one data link. Connecting more than 30 fixtures on one serial data link without the use of a DMX optically isolated splitter may result in deterioration of the digital DMX signal.
-  Maximum recommended DMX data link distance: 100 meters
 Maximum recommended number of fixtures on a DMX data link: 30 fixtures
 Maximum recommended number of fixtures on a power link @110V: 5 fixtures
 Maximum recommended number of fixtures on a power link @240V: 9 fixtures

Data Cabling

To link fixtures together, you must obtain data cables. You can purchase DAP Audio certified DMX cables directly from a dealer/distributor or construct your own cable. If you choose to create your own cable, please use data-grade cables that can carry a high quality signal and are less prone to electromagnetic interference.

DAP Audio DMX Data Cables

- DAP Audio Basic microphone cable for allround use. bal. XLR/M 3-pin > XLR/F 3-pin. **Ordercode** FL01150 (1,5 m), FL013 (3 m), FL016 (6 m), FL0110 (10 m), FL0115 (15 m), FL0120 (20 m).
- DAP Audio X-type data cable XLR/M 3-pin > XLR/F 3-pin. **Ordercode** FLX0175 (0,75 m), FLX01150 (1,5 m), FLX013 (3 m), FLX016 (6 m), FLX0110 (10 m).
- DAP Audio cable for the demanding user with exceptional audio-qualities and connector made by Neutrik®. **Ordercode** FL71150 (1,5 m), FL713 (3 m), FL716 (6 m), FL7110 (10 m).
- DAP Audio cable for the demanding user with exceptional audio-qualities and connector made by Neutrik®. **Ordercode** FL7275 (0,75 m), FL72150 (1,5 m), FL723 (3 m), FL726 (6 m), FL7210 (10 m).
- DAP Audio 110 Ohm cable with digital signal transmission. **Ordercode** FL0975 (0,75 m), FL09150 (1,5 m), FL093 (3 m), FL096 (6 m), FL0910 (10 m), FL0915 (15 m), FL0920 (20 m).
- DAP Audio data cable FL08 DMX/AES-EBU, XLR/M 5-pin > XLR/F 5-pin. **Ordercode** FL08150 (1,5 m), FL083 (3 m), FL086 (6 m), FL0810 (10 m), FL0820 (20 m).
- DAP Audio DMX adapter: 5-pin/3-pin. **Ordercode** FLA29.
- DAP Audio DMX adapter: 3-pin/5-pin. **Ordercode** FLA30.
- DAP Audio DMX Terminator 3-pin. **Ordercode** FLA42.
- DAP Audio DMX Terminator 5-pin. **Ordercode** FLA43.

DAP Audio PC Interface Cables

- CAT-5 cable 7,6 mm Matte blue PVC. **Ordercode** FL55150 (1,5 m), FL553 (3 m), FL556 (6 m), FL5510 (10 m), FL5515 (15 m), FL5520 (20 m).
- CAT-6 cable (recommended for best data transfer). **Ordercode** FL563 (3 m), FL566 (6 m), FL5610 (10 m), FL5615 (15 m), FL5640 (40 m).

Control Panel

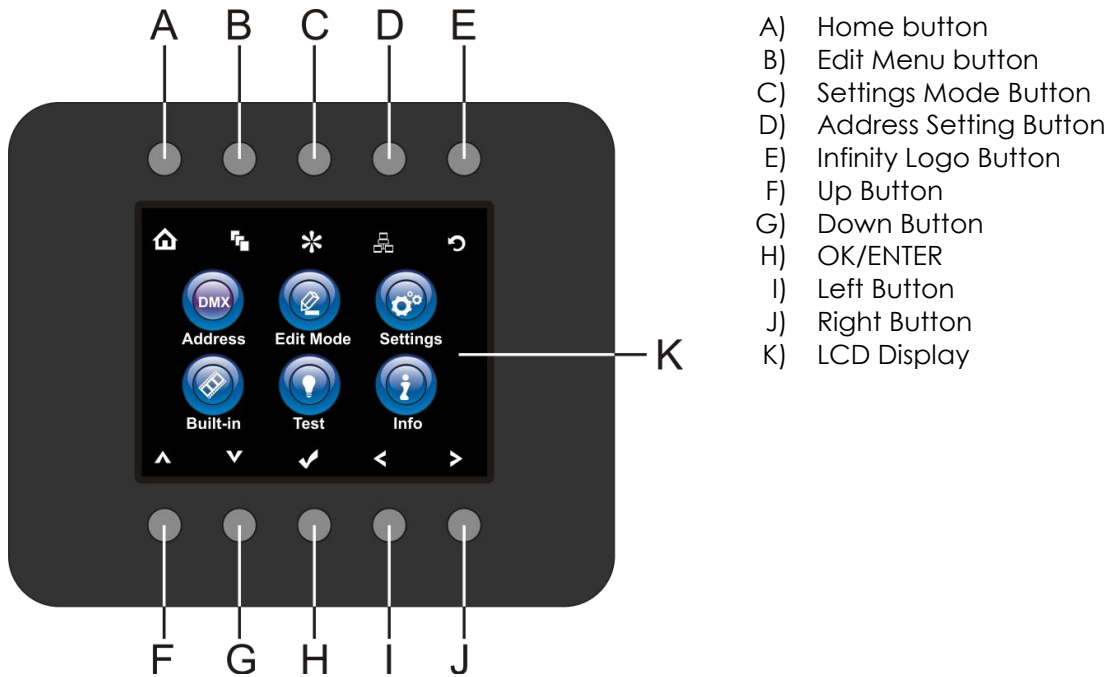

Fig. 06

Control Mode

The fixtures are individually addressed on a data-link and connected to the controller. The fixtures respond to the DMX signal from the controller. (When you select the DMX address and save it, the controller will display the saved DMX address the next time.)

DMX Addressing

The control panel on the front side of the base allows you to assign the DMX fixture address, which is the first channel from which the Infinity will respond to the controller.

Please note when you use the controller, the unit has **97** channels.

When using multiple Infinities, make sure you set the DMX addresses right.

Therefore, the DMX address of the first Infinity should be **1(001)**; the DMX address of the second Infinity should be **1+97=98 (098)**; the DMX address of the third Infinity should be **98+97=195 (195)**, etc.

Please, be sure that you don't have any overlapping channels in order to control each Infinity correctly. If two or more Infinities are addressed similarly, they will work similarly.

Controlling:

After having addressed all Infinity fixtures, you may now start operating these via your lighting controller.

Note: After switching on, the Infinity will automatically detect whether DMX 512 data is received or not. If there is no data received at the DMX-input, the "LED" on the control panel will not flash.

The problem may be:

- The XLR cable from the controller is not connected with the input of the Infinity.
- The controller is switched off or defective, the cable or connector is defective, or the signal wires are swapped in the input connector.

Note: It's necessary to insert a XLR termination plug (with 120 Ohm) in the last fixture in order to ensure proper transmission on the DMX data link.

⚠ Display Off after 40 seconds ⚠

When no button is pressed for 40 seconds, the display will turn off.

To light up the display, you have to press one of the menu buttons described above.

Once you have pressed the button, the display will light up.

Menu Overview



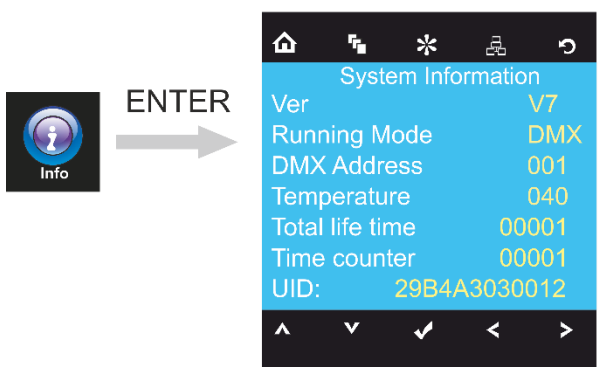

Main Menu Options

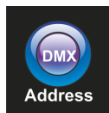

DMX address



Edit Mode

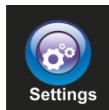

Settings Menu

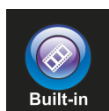

Built-in Programs

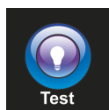

Test Mode



Info



Home



Up



Edit Menu



Down



Setting Mode



OK



Address Setting



Left



Infinity Logo



Right

1. DMX Addressing

With this menu you can set the DMX address.



01) Press the button or press the buttons to select .

02) Now you can adjust either DMX settings or ArtNet settings, depending on the current operating mode.

1.1. DMX settings

01) Press the button, to confirm. You can choose from 512 different DMX addresses.





02) press the and/or buttons to select the required address from ^{Up/Down} .

03) Once you have set the desired DMX address, press the button to store your DMX address.

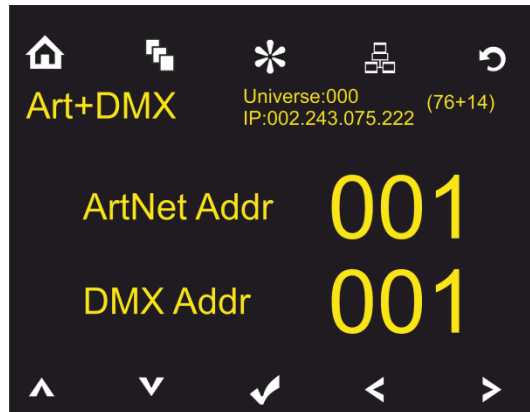
1.2. ArtNet settings (ArtNet + DMX mode)

- 01) Activate **Art + DMX (76+14)** mode (see 2. Edit Mode, page 18).
- 02) Press the  button, to confirm. You can now set the DMX starting address and/or the device's ArtNet address.









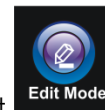

- 03) Press the   buttons to select the digit which you want to adjust.
- 04) Press the   buttons to change the value.
- 05) Once you have made all the desired changes, press the  button to store.



2. Edit Mode

With this menu you can set your desired mode.



- 01) Press the  button or press the     buttons to select .
- 02) Press the  button, to confirm. You can choose one of the 4 available modes.
- 03) Press the   buttons to select the required mode:

DMX MODE 97(CH)	YES
DMX MODE 21(CH)	NO
Art+DMX 76+14	NO
MASTER MODE	NO

- 04) Once you have selected the desired mode, press the   buttons to change the value from NO to YES.
- 05) Press the  button to confirm your choice.
- 06) If the device has been set to Master mode, all the connected slave devices will act the same as the master device.
- 07) If the device has been set to slave, it will react the same as its master device.

3. Settings Menu

With this menu you can set your desired mode.

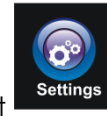

- 01) Press the button or press the buttons to select .
- 02) Press the button, to enter the menu. You can choose from 18 different modes.
- 03) Press the buttons to select the required mode:

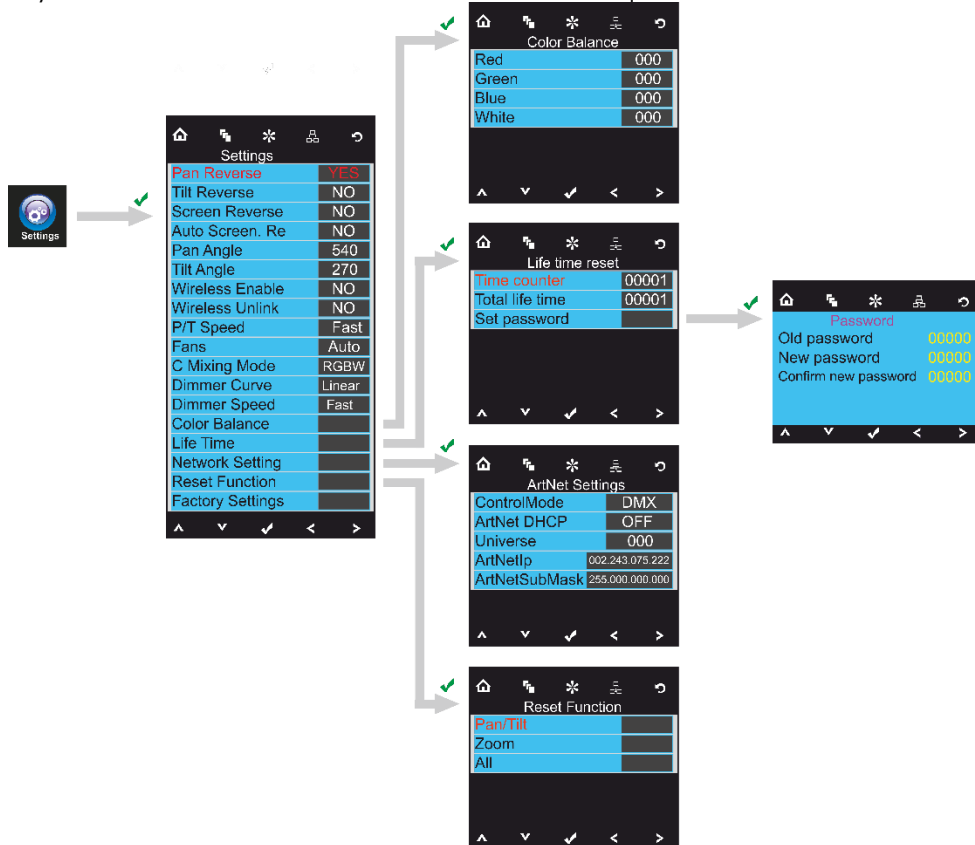

- 04) Once you have selected the desired mode, press the button to proceed to edition.
- 05) Press the buttons to change the value from NO to YES.
- 06) Some of the available menus have different options to the regular, YES or NO function:
 - Pan Angle: 540°, 360°, 180°
 - Tilt Angle: 270°, 180°, 90°
 - P/T Speed: Fast, Slow
 - Fans: Auto, Silent, Full
 - C Mixing Mode: RGBW, CMY
 - Dimmer Curve: Linear, Square, I Squa, SCurve
 - Dimmer Speed: Smooth, Fast









3.1. Color Balance

With this menu you can set the device's color brightness.

- 01) Press the buttons to select Color Balance and press the button to open the menu.
- 02) You can now adjust 4 colors: Red, Green, Blue, White.
- 03) Choose the desired color, press the button and then press the buttons to set the value. The adjustment range is between 0-255, from dark to brightest.
- 04) You can combine Red, Green, Blue and White to create an infinite range of colors.
- 05) If you want to use the Infinity in **ArtNet+DMX mode**, the color balance of all the 4 colors must be set to **0**. Otherwise, the device will not function properly.

3.2. Life Time

With this menu you can reset the device's counters.





- 01) Press the   buttons to select Life Time and press the  button to open the menu.
- 02) Press the   buttons to choose one of the 3 reset options:
 - Time Counter (the time counter will be reset)
 - Total Life Time (the device's operation time counter will be reset)
 - Set Password
- 03) If you select Time Counter or Total Life Time, press the  button to open the selection menu.
- 04) Press the   buttons to choose either YES or NO. Press the  button to confirm.

3.2.1. Set Password

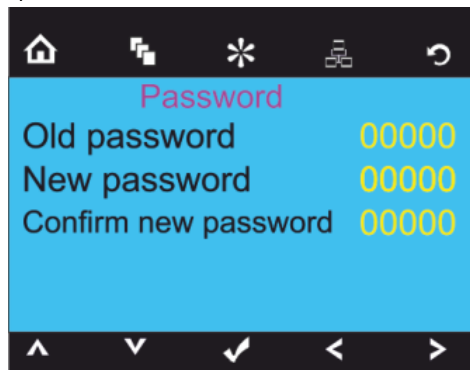
With this menu you can set the new password for the device.



- 01) Press the   buttons to select Set Password and press the  button to open the menu.
- 02) The following screen will pop up:







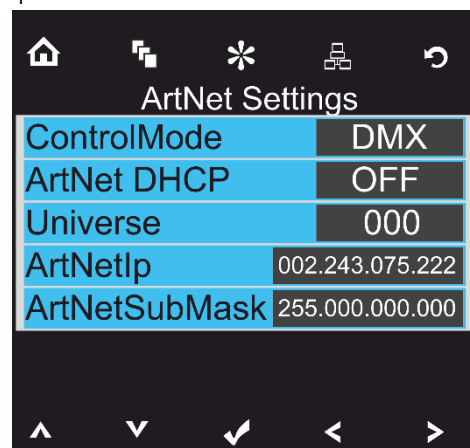

- 03) Press the   buttons to select the digit which you want to edit.
- 04) Press the   buttons to adjust the values.

3.2.2. Network Setting

With this menu you can set the device's network settings.









- 01) Press the   buttons to select Network Settings and press the  button to open the menu.
- 02) The following screen will pop up:



- 03) Press the   buttons to choose one of the 4 options:
- Control mode ArtNet (Only 97CH Mode),
DMX(21 or 97CH Mode)
ArtNet + DMX (76+14 Channels)
 - ArtNet DHCP (ON/OFF)
 - Universe (the device's universe, 0-255)
 - ArtNet IP
 - ArtNet submask
- 04) If you have chosen the desired option, press the  button to proceed to edition mode.
- 05) Press the   buttons to adjust the options.
- 06) Press the  button to confirm your choice.









3.3. Reset

With this menu you can reset the device's settings.

- 01) In Settings menu, press the   buttons to select Reset Function and press the  button to open the menu.
- 02) Press the   buttons to choose one of the 2 options:
- Pan/Tilt (Pan/Tilt reset)
 - Zoom (zoom reset)
 - All (complete settings reset)
- 03) Once you have chosen the desired option, press the  button to proceed to edition mode.
- 04) Press the   buttons to choose between YES or NO.
- 05) Press the  button to confirm your choice.



4. Built-in Programs

With this menu you can set your desired built-in program.

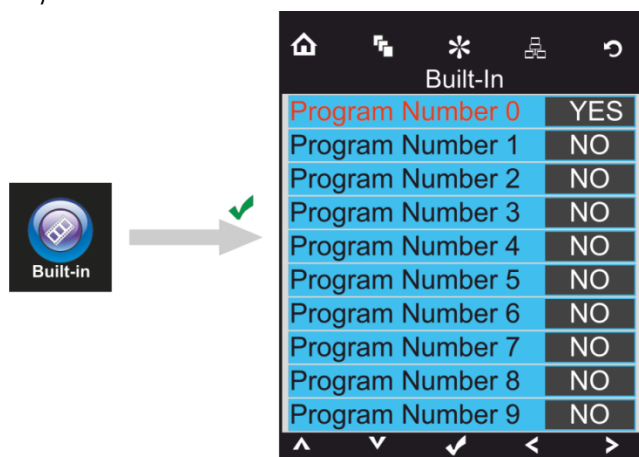
- 01) Press the  button or press the     buttons to select .
- 02) Press the  button to enter the menu.
- 03) Press the   buttons to select the desired built-in program.













- 04) Press the  button to confirm your choice.





05) Press the   buttons to choose either YES or NO and press the  button to activate the desired built-in program.

5. Test Menu

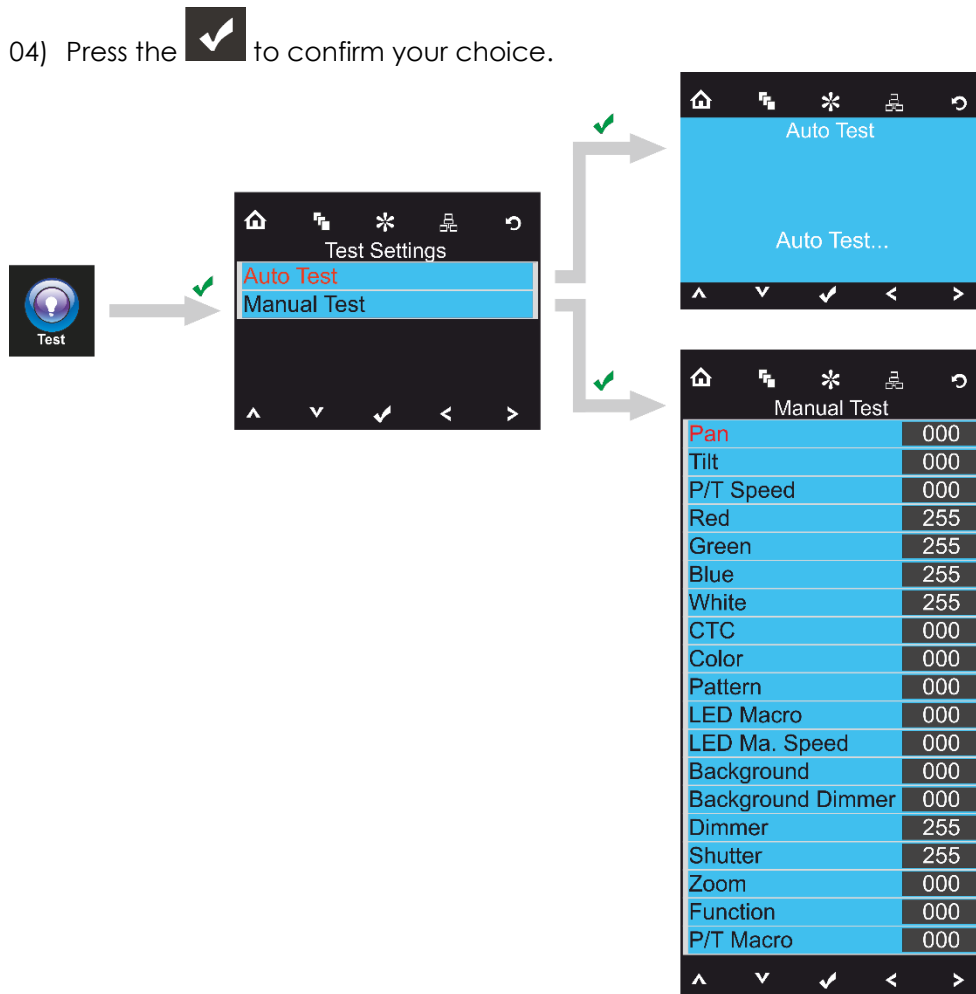
With this menu you can set your desired mode.







- 01) Press the  button or press the     buttons to select .
- 02) Press the  button to enter the menu.
- 03) Press the   buttons to choose one of the 2 modes:
 - Auto Test
 - Manual Test
- 04) Press the  to confirm your choice.



- 05) If you have selected Auto Test mode, the device will automatically test all its functions.
- 06) If you have selected Manual Test mode, press the   buttons to select the desired option.
- 07) Press the   buttons to change the values from 0 to 255.
- 08) Once you have adjusted the desired setting, press the  button to store changes.

6. System information

With this menu you can set your desired mode.

- 01) Press the  button or press the     buttons to select .
- 02) Press the  button to enter the menu.
- 03) The following screen will pop up:

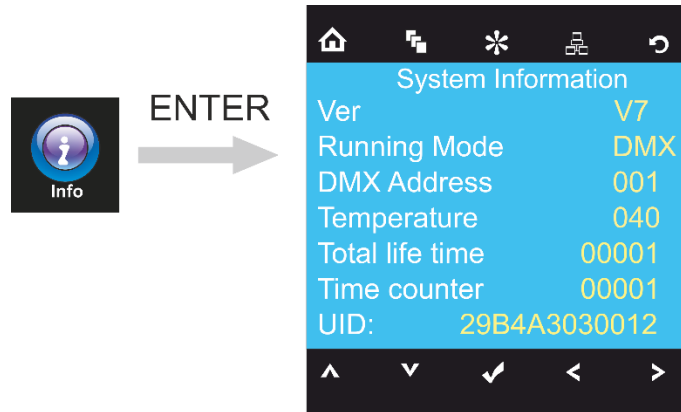

- 04) You can now monitor the device's current software version, current active mode, current DMX starting address, current temperature, total operation time, time counter and the device's unique identifier (UID).

DMX Channels

21 channels

Channel 1 – Horizontal movement (Pan)

Push the slider up, in order to move head horizontally (PAN).
Gradual head adjustment from one end of the slider to the other (0-255, 128-center).
The head can be turned by 540° and stopped at any position you wish.

Channel 2 – Vertical movement (Tilt)

Push the slider up, in order to move head vertically (TILT).
Gradual head adjustment from one end of the slider to the other (0-255, 128-center).
The head can be turned by 270° and stopped at any position you wish.

Channel 3 – Pan fine 16 bit

Channel 4 – Tilt fine 16 bit

Channel 5 – PAN/TILT Speed

0-255 From fast to slow

Channel 6 – Red CH17-18 must be open

0-255 Gradual adjustment Red, from dark to brightest

Channel 7 – Green CH17-18 must be open

0-255 Gradual adjustment Green, from dark to brightest

Channel 8 – Blue CH17-18 must be open

0-255 Gradual adjustment Blue, from dark to brightest

Channel 9 – White ⚠ **CH17-18 must be open** ⚠

0-255 Gradual adjustment White, from dark to brightest

Channel 10 – Color temperature (CTO) ⚠ **CH06-CH9 must be open** ⚠

0 Not functional

1-255 Color temperature, from 19000K to 2700K

Channel 11 – Color Macro

0 Not functional

1-2 White 2700K

3-4 White 3200K

5-6 White 4200K

7-8 White 5600K

9-10 White 8000K

11 Blue (R=0, G=0, B=255, W=0)

12-48 R=0, G=0, B=255, W=0

49 Cyan (R=0, G=255, B=255, W=0)

50-86 R=0, G=255, B-, W=0

87 Green (R=0, G=255, B=0, W=0)

88-124 R+, G=255, B=0, W=0

125 Yellow (R=255, G=255, B=0, W=0)

126-162 R=255, G-, B=0, W=0

163 Red (R=255, G=0, B=0, W=0)

164-200 R=255, G=0, B+, W=0

201 Purple (R=255, G=0, B=255, W=0)

202-238 R-, G=0, B=255, W=0

239 Blue (R=0, G=0, B=255, W=0)

240-247 Color flow, from fast to slow

248-255 Color switch, from fast to slow

Channel 12 – LED control (Fixed Gobo Macros)

⚠ **CH6-CH9 must be open / or CH11 must be open / or CH6-CH9 + CH10 must be open** ⚠

0 All LEDs ON

1 LED program 1

2 LED program 2

3 LED program 3

4 LED program 4

5 LED program 5

6 LED program 6

7 LED program 7

8 LED program 8

9 LED program 9

10 LED program 10

11 LED program 11

12 LED program 12

• • •
• • •
• • •

251 LED program 250

252 LED program 251

253 LED program 252

254 LED program 253

255 All LEDs ON

Channel 13 – Rotating built-in programs

 **CH6-CH9 must be open / or CH11 must be open / or CH6-CH9 + CH10 must be open** 

0-15	Not functional			
16	Built-in program 1 (Gobo Macro)			
17	Built-in program 2 (Gobo Macro)			
18	Built-in program 3 (Gobo Macro)			
19	Built-in program 4 (Gobo Macro)			
20	Built-in program 5 (Gobo Macro)			
		•	•	•
		•	•	•
		•	•	•
114	Built-in program 99 (Gobo Macro)			
115	Built-in program 100 (Gobo Macro)			
116	Built-in program 101 (Gobo Macro)			
117-135	Built-in program 102 (Gobo built-in program)			
136	Built-in program 103 (Color + Gobo Macro)			
		•	•	•
		•	•	•
		•	•	•
234	Built-in program 201 (Color + Gobo Macro)			
235	Built-in program 202 (Color + Gobo Macro)			
236	Built-in program 203 (Color + Gobo Macro)			
237-255	Built-in program 204 (main built-in program)			

Channel 14 – Rotating built-in program speed



0	Stop
1-255	Program speed adjustment, from slow to fast

Channel 15 – Background Color

 **CH13 must be set between 16-135, CH17 has no function; use CH16 to dim** 

0	Not functional
1-2	White 2700K
3-4	White 3200K
5-6	White 4200K
7-8	White 5600K
9-10	White 8000K
11	Blue (R=0, G=0, B=255, W=0)
12-48	R=0, G=0, B=255, W=0
49	Cyan (R=0, G=255, B=255, W=0)
50-86	R=0, G=255, B=, W=0
87	Green (R=0, G=255, B=0, W=0)
88-124	R+, G=255, B=0, W=0
125	Yellow (R=255, G=255, B=0, W=0)
126-162	R=255, G-, B=0, W=0
163	Red (R=255, G=0, B=0, W=0)
164-200	R=255, G=0, B+, W=0
201	Purple (R=255, G=0, B=255, W=0)
202-238	R-, G=0, B=255, W=0
239	Blue (R=0, G=0, B=255, W=0)
240-247	Color flow, from fast to slow
248-255	Color switch, from fast to slow

Channel 16 – Background Color dimmer

 **CH12 must be open and CH13 must be set between 16-135** 

0-255 Dimmer intensity, from OFF to full ON

Channel 17 – Master dimmer  **CH13 must be set between 136-255** 

0-255 Dimmer intensity, from OFF to full ON

Channel 18 – Shutter / Strobe  **CH17 must be open** 

0-19 Close

20-24 Shutter open

25-64 Strobe effect 1, from fast to slow

65-69 Shutter open

70-84 Strobe effect 2 (fast on and slow off), from fast to slow

85-89 Shutter open

90-104 Strobe effect 3 (slow on and fast off), from fast to slow

105-109 Shutter open

110-124 Strobe effect 4 (random strobe), from fast to slow

125-129 Shutter open

130-144 Strobe effect 5 (random strobe fast on and slow off), from fast to slow

145-149 Shutter open

150-164 Strobe effect 6 (random strobe slow on and fast off), from fast to slow

165-169 Shutter open

170-184 Strobe effect 7 (pulse strobe), from fast to slow

185-189 Shutter open

190-204 Strobe effect 8 (random pulse frequency strobe), from fast to slow

205-209 Shutter open

210-224 Strobe effect 9 (strobe light, gradually destroy), from fast to slow

225-229 Shutter open

230-244 Strobe effect 10 (pulse strobe), from fast to slow

245-255 Shutter open

Channel 19 – Zoom

0-255 Zoom adjustment, from small to big

Channel 20 – Functions

0-9 Not functional

10-14 Pan/Tilt blackout

15-19 Not functional

20-24 RGBW color mixing, after 5 seconds

25-29 CMY color mixing, after 5 seconds

30-34 Light delay OFF

35-39 Light delay ON

40-49 Not functional

50-54 Pan reset, after 5 seconds

55-59 Tilt reset, after 5 seconds

60-64 Zoom reset

65-69 Not functional

70-74 Pan/Tilt reset, after 5 seconds

75-114 Not functional

115-119 Pan/Tilt fast, after 5 seconds

120-124 Pan/Tilt slow, after 5 seconds

125-129 Cooling fan full speed, after 5 seconds

130-134 Cooling fan temperature dependent, after 5 seconds

135-139 Fast dimmer, after 5 seconds

140-144 Slow dimmer, after 5 seconds

145-255 Not functional

Channel 21 – Moving head built-in programs

0-7	Not functional
8-23	Built-in program 1
24-39	Built-in program 2
40-55	Built-in program 3
56-71	Built-in program 4
72-87	Built-in program 5
88-103	Built-in program 6
104-119	Built-in program 7
120-135	Built-in program 8
136-151	Built-in program 9
152-167	Built-in program 10
168-183	Built-in program 11
184-199	Built-in program 12
200-215	Built-in program 13
216-231	Built-in program 14
232-247	Built-in program 15
248-255	Built-in program 16

97 channels

Channel 1 – Horizontal movement (Pan)

Push the slider up, in order to move head horizontally (PAN).

Gradual head adjustment from one end of the slider to the other (0-255, 128-center).
The head can be turned by 540° and stopped at any position you wish.

Channel 2 – Vertical movement (Tilt)

Push the slider up, in order to move head vertically (TILT).

Gradual head adjustment from one end of the slider to the other (0-255, 128-center).
The head can be turned by 270° and stopped at any position you wish.

Channel 3 – Pan fine 16 bit

Channel 4 – Tilt fine 16 bit

Channel 5 – PAN/TILT Speed

0-255 From fast to slow

Channel 6 – Red CH93-94 must be open

0-255 Gradual adjustment Red, from dark to brightest

Channel 7 – Green CH93-94 must be open

0-255 Gradual adjustment Green, from dark to brightest

Channel 8 – Blue CH93-94 must be open

0-255 Gradual adjustment Blue, from dark to brightest

Channel 9 – White CH93-94 must be open

0-255 Gradual adjustment White, from dark to brightest

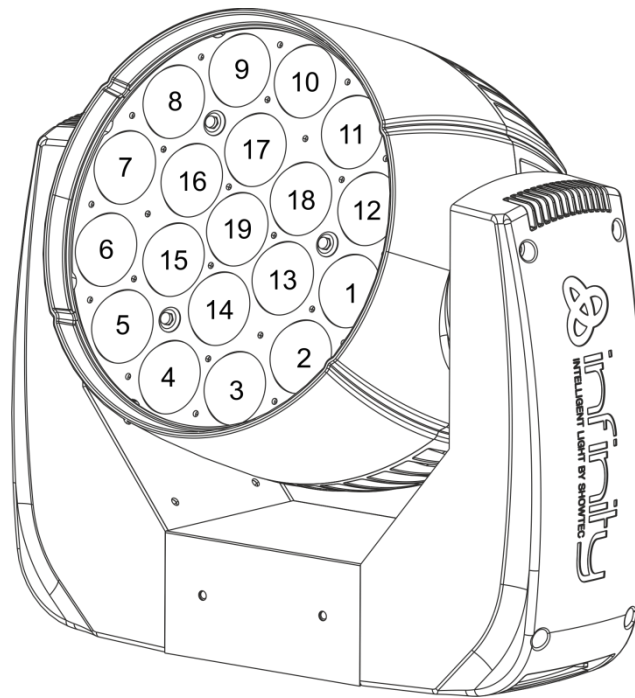

Channel 10 – Red 1 ⚠ **CH93-94 must be open** ⚠
 0-255 Gradual adjustment Red, from dark to brightest

Channel 11 – Green 1 ⚠ **CH93-94 must be open** ⚠
 0-255 Gradual adjustment Green, from dark to brightest

Channel 12 – Blue 1 ⚠ **CH93-94 must be open** ⚠
 0-255 Gradual adjustment Blue, from dark to brightest

Channel 13 – White 1 ⚠ **CH93-94 must be open** ⚠
 0-255 Gradual adjustment White, from dark to brightest

Channel 14 – Red 2 ⚠ **CH93-94 must be open** ⚠
 0-255 Gradual adjustment Red, from dark to brightest

Channel 15 – Green 2 ⚠ **CH93-94 must be open** ⚠
 0-255 Gradual adjustment Green, from dark to brightest

Channel 16 – Blue 2 ⚠ **CH93-94 must be open** ⚠
 0-255 Gradual adjustment Blue, from dark to brightest

Channel 17 – White 2 ⚠ **CH93-94 must be open** ⚠
 0-255 Gradual adjustment White, from dark to brightest

• • •
 • • •
 • • •

Channel 82 – Red 19  **CH93-94 must be open** 
 0-255 Gradual adjustment Red, from dark to brightest

Channel 83 – Green 19  **CH93-94 must be open** 
 0-255 Gradual adjustment Green, from dark to brightest

Channel 84 – Blue 19  **CH93-94 must be open** 
 0-255 Gradual adjustment Blue, from dark to brightest



Channel 85 – White 19  **CH93-94 must be open** 
 0-255 Gradual adjustment White, from dark to brightest

Channel 86 – Color temperature (CTO)  **CH06-CH9 must be open** 
 0 Not functional
 1-255 Color temperature, from 19000K to 2700K

Channel 87 – Color Macro

0 Not functional
 1-2 White 2700K
 3-4 White 3200K
 5-6 White 4200K
 7-8 White 5600K
 9-10 White 8000K
 11 Blue (R=0, G=0, B=255, W=0)
 12-48 R=0, G=0, B=255, W=0
 49 Cyan (R=0, G=255, B=255, W=0)
 50-86 R=0, G=255, B-, W=0
 87 Green (R=0, G=255, B=0, W=0)
 88-124 R+, G=255, B=0, W=0
 125 Yellow (R=255, G=255, B=0, W=0)
 126-162 R=255, G-, B=0, W=0
 163 Red (R=255, G=0, B=0, W=0)
 164-200 R=255, G=0, B+, W=0
 201 Purple (R=255, G=0, B=255, W=0)
 202-238 R-, G=0, B=255, W=0
 239 Blue (R=0, G=0, B=255, W=0)
 240-247 Color flow, from fast to slow
 248-255 Color switch, from fast to slow

Channel 88 – LED control (Fixed Gobo Macros)

 **CH6-CH85 must be open / or CH87 must be open / or CH6-CH85 + CH86 must be open** 

0 All LEDs ON
 1 LED program 1
 2 LED program 2
 3 LED program 3
 4 LED program 4
 5 LED program 5
 6 LED program 6
 7 LED program 7
 8 LED program 8
 9 LED program 9
 10 LED program 10
 11 LED program 11
 12 LED program 12

	•	•	•
	•	•	•
	•	•	•
251	LED program 250		
252	LED program 251		
253	LED program 252		
254	LED program 253		
255	All LEDs ON		

Channel 89 – Rotating built-in programs



 **CH6-CH85 must be open / or CH87 must be open / or CH6-CH85 + CH86 must be open** 

0-15	Not functional		
16	Built-in program 1 (Gobo Macro)		
17	Built-in program 2 (Gobo Macro)		
18	Built-in program 3 (Gobo Macro)		
19	Built-in program 4 (Gobo Macro)		
20	Built-in program 5 (Gobo Macro)		
	•	•	•
	•	•	•
	•	•	•
114	Built-in program 99 (Gobo Macro)		
115	Built-in program 100 (Gobo Macro)		
116	Built-in program 101 (Gobo Macro)		
117-135	Built-in program 102 (Gobo built-in program)		
136	Built-in program 103 (Color + Gobo Macro)		
	•	•	•
	•	•	•
	•	•	•
234	Built-in program 201 (Color + Gobo Macro)		
235	Built-in program 202 (Color + Gobo Macro)		
236	Built-in program 203 (Color + Gobo Macro)		
237-255	Built-in program 204 (main built-in program)		

Channel 90 – Rotating built-in program speed

0	Stop		
1-255	Program speed adjustment, from slow to fast		



Channel 91 – Background Color

 **CH89 must be set between 16-135, CH93 has no function; use CH92 to dim** 

0	Not functional		
1-2	White 2700K		
3-4	White 3200K		
5-6	White 4200K		
7-8	White 5600K		
9-10	White 8000K		
11	Blue (R=0, G=0, B=255, W=0)		
12-48	R=0, G=0, B=255, W=0		
49	Cyan (R=0, G=255, B=255, W=0)		
50-86	R=0, G=255, B=, W=0		
87	Green (R=0, G=255, B=0, W=0)		
88-124	R+, G=255, B=0, W=0		

125	Yellow (R=255, G=255, B=0, W=0)
126-162	R=255, G-, B=0, W=0
163	Red (R=255, G=0, B=0, W=0)
164-200	R=255, G=0, B+, W=0
201	Purple (R=255, G=0, B=255, W=0)
202-238	R-, G=0, B=255, W=0
239	Blue (R=0, G=0, B=255, W=0)
240-247	Color flow, from fast to slow
248-255	Color switch, from fast to slow

Channel 92 – Background Color dimmer

 **CH88 must be open and CH89 must be set between 16-135** 

0-255	Dimmer intensity, from OFF to full ON
-------	---------------------------------------

Channel 93 – Master dimmer CH89 must be set between 136-255

0-255	Dimmer intensity, from OFF to full ON
-------	---------------------------------------

Channel 94 – Shutter / Strobe CH93 must be open

0-19	Close
20-24	Shutter open
25-64	Strobe effect 1, from fast to slow
65-69	Shutter open
70-84	Strobe effect 2 (fast on and slow off), from fast to slow
85-89	Shutter open
90-104	Strobe effect 3 (slow on and fast off), from fast to slow
105-109	Shutter open
110-124	Strobe effect 4 (random strobe), from fast to slow
125-129	Shutter open
130-144	Strobe effect 5 (random strobe fast on and slow off), from fast to slow
145-149	Shutter open
150-164	Strobe effect 6 (random strobe slow on and fast off), from fast to slow
165-169	Shutter open
170-184	Strobe effect 7 (pulse strobe), from fast to slow
185-189	Shutter open
190-204	Strobe effect 8 (random pulse frequency strobe), from fast to slow
205-209	Shutter open
210-224	Strobe effect 9 (strobe light, gradually destroy), from fast to slow
225-229	Shutter open
230-244	Strobe effect 10 (pulse strobe), from fast to slow
245-255	Shutter open

Channel 95 – Zoom

0-255	Zoom adjustment, from small to big
-------	------------------------------------

Channel 96 – Functions

0-9	Not functional
10-14	Pan/Tilt blackout
15-19	Not functional
20-24	RGBW color mixing, after 5 seconds
25-29	CMY color mixing, after 5 seconds
30-34	Light delay OFF
35-39	Light delay ON
40-49	Not functional
50-54	Pan reset, after 5 seconds
55-59	Tilt reset, after 5 seconds
60-64	Zoom reset
65-69	Not functional
70-74	Pan/Tilt reset, after 5 seconds
75-114	Not functional
115-119	Pan/Tilt fast, after 5 seconds
120-124	Pan/Tilt slow, after 5 seconds
125-129	Cooling fan full speed, after 5 seconds
130-134	Cooling fan temperature dependent, after 5 seconds
135-139	Fast dimmer, after 5 seconds
140-144	Slow dimmer, after 5 seconds
145-255	Not functional

Channel 97 – Moving head built-in programs

0-7	Not functional
8-23	Built-in program 1
24-39	Built-in program 2
40-55	Built-in program 3
56-71	Built-in program 4
72-87	Built-in program 5
88-103	Built-in program 6
104-119	Built-in program 7
120-135	Built-in program 8
136-151	Built-in program 9
152-167	Built-in program 10
168-183	Built-in program 11
184-199	Built-in program 12
200-215	Built-in program 13
216-231	Built-in program 14
232-247	Built-in program 15
248-255	Built-in program 16

For the most creative effects, you should combine CH6-CH85 and CH88-CH92.
When CH89 is set between 136-255, CH91 +CH92 do not function

 **CH93+94 must be open** 

76+14 channels (ArtNet + DMX mode)

ArtNet

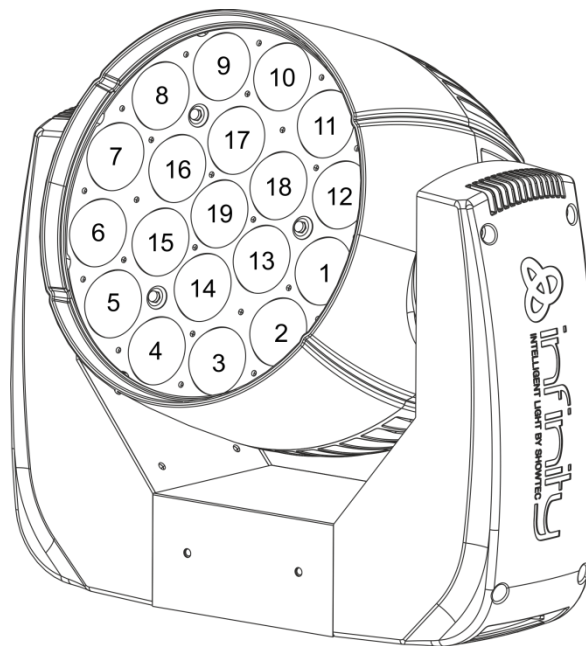

Channel 1 – Red 1 ⚠️ **DMX CH10-11 must be open** ⚠️
0-255 Gradual adjustment Red, from dark to brightest

Channel 2 – Green 1 ⚠️ **DMX CH10-11 must be open** ⚠️
0-255 Gradual adjustment Green, from dark to brightest

Channel 3 – Blue 1 ⚠️ **DMX CH10-11 must be open** ⚠️
0-255 Gradual adjustment Blue, from dark to brightest

Channel 4 – White 1 ⚠️ **DMX CH10-11 must be open** ⚠️
0-255 Gradual adjustment White, from dark to brightest

Channel 5 – Red 2 ⚠️ **DMX CH10-11 must be open** ⚠️
0-255 Gradual adjustment Red, from dark to brightest

Channel 6 – Green 2 ⚠️ **DMX CH10-11 must be open** ⚠️
0-255 Gradual adjustment Green, from dark to brightest

Channel 7 – Blue 2 ⚠️ **DMX CH10-11 must be open** ⚠️
0-255 Gradual adjustment Blue, from dark to brightest

Channel 8 – White 2  DMX CH10-11 must be open 

0-255 Gradual adjustment White, from dark to brightest

-
-
-

Channel 73 – Red 19  DMX CH10-11 must be open 

0-255 Gradual adjustment Red, from dark to brightest

Channel 74 – Green 19  DMX CH10-11 must be open 

0-255 Gradual adjustment Green, from dark to brightest

Channel 75 – Blue 19  DMX CH10-11 must be open 

0-255 Gradual adjustment Blue, from dark to brightest

Channel 76 – White 19  DMX CH10-11 must be open 

0-255 Gradual adjustment White, from dark to brightest

DMX

Channel 1 – Horizontal movement (Pan)

Push the slider up, in order to move head horizontally (PAN).
Gradual head adjustment from one end of the slider to the other (0-255, 128-center).
The head can be turned by 540° and stopped at any position you wish.

Channel 2 – Vertical movement (Tilt)

Push the slider up, in order to move head vertically (TILT).
Gradual head adjustment from one end of the slider to the other (0-255, 128-center).
The head can be turned by 270° and stopped at any position you wish.

Channel 3 – Pan fine 16 bit

Channel 4 – Tilt fine 16 bit

Channel 5 – PAN/TILT Speed

0-255 From fast to slow

Channel 6 – Red  DMX CH10-11 must be open 

0-255 Gradual adjustment Red, from dark to brightest

Channel 7 – Green  DMX CH10-11 must be open 

0-255 Gradual adjustment Green, from dark to brightest

Channel 8 – Blue  DMX CH10-11 must be open 

0-255 Gradual adjustment Blue, from dark to brightest

Channel 9 – White  DMX CH10-11 must be open 

0-255 Gradual adjustment White, from dark to brightest

Channel 10 – Master dimmer

0-255 Dimmer intensity, from OFF to full ON

Channel 11 – Shutter / Strobe ⚠️ **DMX CH10 must be open** ⚠️

0-19	Close
20-24	Shutter open
25-64	Strobe effect 1, from fast to slow
65-69	Shutter open
70-84	Strobe effect 2 (fast on and slow off), from fast to slow
85-89	Shutter open
90-104	Strobe effect 3 (slow on and fast off), from fast to slow
105-109	Shutter open
110-124	Strobe effect 4 (random strobe), from fast to slow
125-129	Shutter open
130-144	Strobe effect 5 (random strobe fast on and slow off), from fast to slow
145-149	Shutter open
150-164	Strobe effect 6 (random strobe slow on and fast off), from fast to slow
165-169	Shutter open
170-184	Strobe effect 7 (pulse strobe), from fast to slow
185-189	Shutter open
190-204	Strobe effect 8 (random pulse frequency strobe), from fast to slow
205-209	Shutter open
210-224	Strobe effect 9 (strobe light, gradually destroy), from fast to slow
225-229	Shutter open
230-244	Strobe effect 10 (pulse strobe), from fast to slow
245-255	Shutter open

Channel 12 – Zoom

0-255	Zoom adjustment, from small to big
-------	------------------------------------

Channel 13 – Functions

0-9	Not functional
10-14	Pan/Tilt blackout
15-19	Not functional
20-24	RGBW color mixing, after 5 seconds
25-29	CMY color mixing, after 5 seconds
30-34	Light delay OFF
35-39	Light delay ON
40-49	Not functional
50-54	Pan reset, after 5 seconds
55-59	Tilt reset, after 5 seconds
60-64	Zoom reset
65-69	Not functional
70-74	Pan/Tilt reset, after 5 seconds
75-114	Not functional
115-119	Pan/Tilt fast, after 5 seconds
120-124	Pan/Tilt slow, after 5 seconds
125-129	Cooling fan full speed, after 5 seconds
130-134	Cooling fan temperature dependent, after 5 seconds
135-139	Fast dimmer, after 5 seconds
140-144	Slow dimmer, after 5 seconds
145-255	Not functional

Channel 14 – Moving head built-in programs

0-7	Not functional
8-23	Built-in program 1
24-39	Built-in program 2
40-55	Built-in program 3
56-71	Built-in program 4

72-87	Built-in program 5
88-103	Built-in program 6
104-119	Built-in program 7
120-135	Built-in program 8
136-151	Built-in program 9
152-167	Built-in program 10
168-183	Built-in program 11
184-199	Built-in program 12
200-215	Built-in program 13
216-231	Built-in program 14
232-247	Built-in program 15
248-255	Built-in program 16

Channel Settings

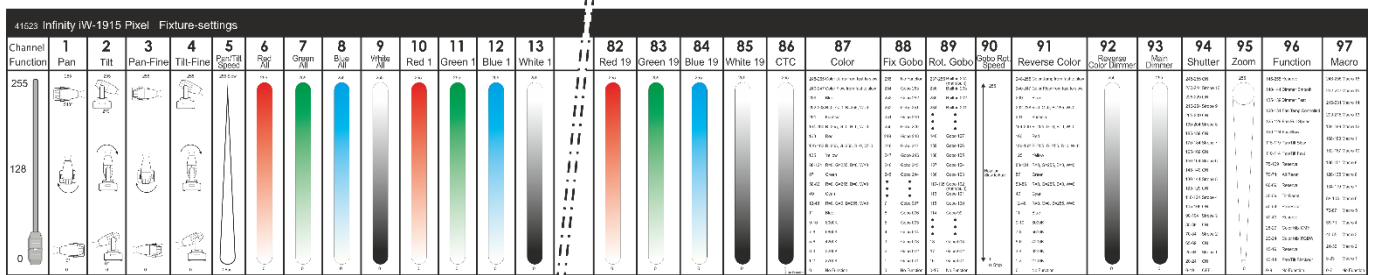

Fig. 07

Connecting to a Network

ArtNet settings

- 01) Install any ArtNet-based software on your PC (Windows, Mac or user console with ArtNet support).
- 02) Connect the power supply to the Infinity.
- 03) Connect the device's Ethernet connector (**06**) to your software/light controller's Ethernet connector, using a CAT-5/CAT-6 cable.
- 04) Set the IP address of your software/light controller to **2.x.x.x** or **10.x.x.x**, depending on the ArtNet settings.
- 05) Set the subnet mask to **255.0.0.0** on both – the Infinity and your software/light controller. Make sure that all the fixtures in the network have a **unique IP address**.
- 06) If you want to connect more than one fixture, follow the example below.

Example:

- 01) Make sure that each connected Infinity has a **unique IP address**.
- 02) Make sure that the subnet mask on each device is set to **255.0.0.0**.
- 03) Set the universe of the first Infinity to **1**.
- 04) Set the first Infinity's DMX address to **001**.
- 05) If you have reached the DMX limit of 512 channels, while connecting multiple Infinities, set the universe of the following Infinity to **2** and its DMX address to **001**.
- 06) Repeat step 5 up to 255 times (as there are 255 universes available).
- 07) Using your software, map all the connected devices, using the settings described above.
- 08) The Infinities are now ready for use.
- 09) When creating large setups, it is recommended to use a 16-bit, high speed ethernet switch to distribute the ArtNet data signal.

How to make a data cable

A Standard ETHERNET Cable can be used to replace the Data Cable required to transmit the data for the iW-1915 Pixel.

Please follow the instructions below in order to create an extra Net Cable.

Take a standard net cable (CAT-5/ 5E /6) and connect it to the RJ45 connector, as shown in the picture below (fig. 08). The wires should now be colored as follows:

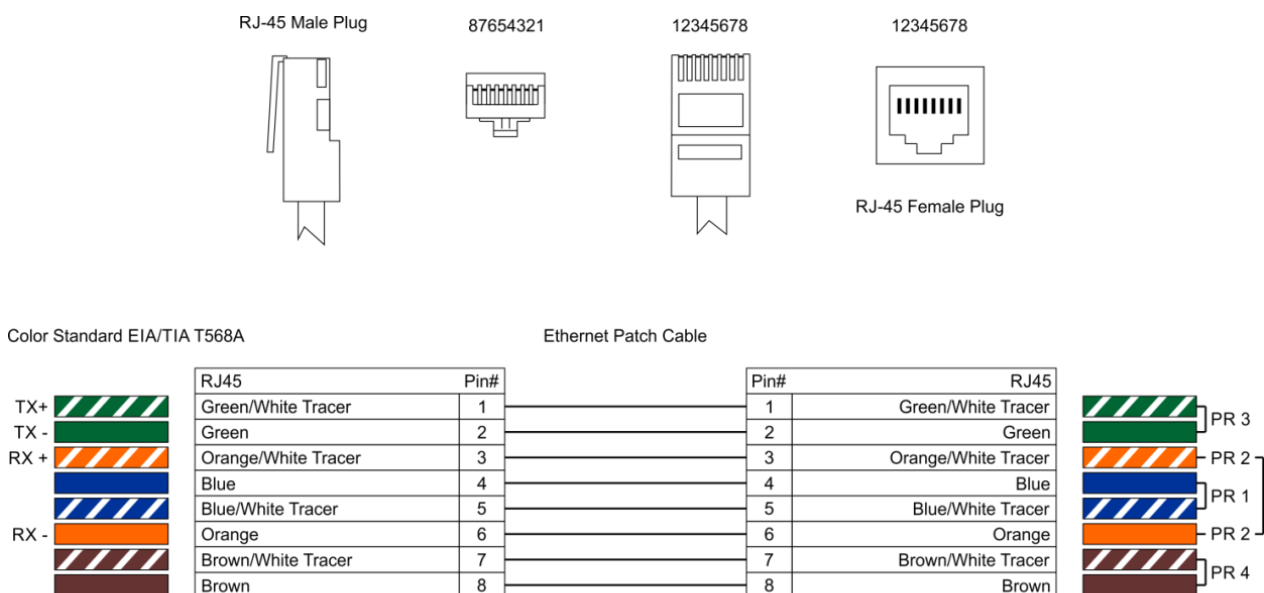

Fig. 08

Maintenance

The operator has to make sure that safety-related and machine-technical installations are to be inspected by an expert after every year in the course of an acceptance test.

The operator has to make sure that safety-related and machine-technical installations are to be inspected by a skilled person once a year.

The following points have to be considered during the inspection:

- 01) All screws used for installing the device or parts of the device have to be tightly connected and must not be corroded.
- 02) There may not be any deformations on housings, fixations and installation spots.
- 03) Mechanically moving parts like axles, eyes and others may not show any traces of wearing.
- 04) The electric power supply cables must not show any damages or material fatigue.

The iW-1915 Pixel requires almost no maintenance. However, you should keep the unit clean.

Otherwise, the fixture's light output will be significantly reduced. Disconnect the mains power supply, and then wipe the cover with a damp cloth. Do not immerse in liquid. Wipe lens clean with glass cleaner and a soft cloth. Do not use alcohol or solvents.

The front lens will require weekly cleaning, as smoke-fluid tends to build up residues, reducing the light-output very quickly.

The cooling fans should be cleaned monthly, with a soft brush.

Please clean internal components once a year with a light brush and vacuum cleaner.

Keep connections clean. Disconnect electric power, and then wipe the DMX connections with a damp cloth. Make sure connections are thoroughly dry before linking equipment or supplying electric power.

Replacing the Fuse

Power surges, short-circuit or inappropriate electrical power supply may cause a fuse to burn out. If the fuse burns out, the product will not function whatsoever. If this happens, follow the directions below:

- 01) Unplug the unit from electric power source.
- 02) Insert a flat-head screwdriver into a slot in the fuse cover. Turn the screwdriver to the left, at the same time gently push a bit (Turn and Push). The fuse will come out.
- 03) Remove the used fuse. If brown or unclear, it is burned out.
- 04) Insert the replacement fuse into the holder where the old fuse was. Reinsert the fuse cover. Be sure to use a fuse of the same type and specification. See the product specification label for details.

Troubleshooting

This troubleshooting guide is meant to help solve simple problems.

If a problem occurs, carry out the steps below in sequence until a solution is found. Once the unit operates properly, do not carry out following steps.

No Light

If the light effect does not operate properly, refer servicing to a technician.

Suspect three potential problem areas as: the power supply, the LEDs, the fuse.

- 01) Power supply. Check if the unit is plugged into an appropriate power supply.
- 02) The LEDs. Return the Infinity to your Infinity dealer.
- 03) The fuse. Replace the fuse. See page 38 for replacing the fuse.
- 04) If all of the above appears to be O.K., plug the unit in again.
- 05) If you are unable to determine the cause of the problem, do not open the Infinity, as this may damage the unit and the warranty will become void.
- 06) Return the device to your Infinity dealer.

No Response to DMX

Suspect the DMX cable or connectors, a controller malfunction, a light effect DMX card malfunction.

- 01) Check the DMX setting. Make sure that DMX addresses are correct.
- 02) Check the DMX cable: Unplug the unit; change the DMX cable; then reconnect to electrical power. Try your DMX control again.
- 03) Determine whether the controller or light effect is at fault. Does the controller operate properly with other DMX products? If not, take the controller in for repair. If so, take the DMX cable and the light effect to a qualified technician.

Problem	Probable cause(s)	Solution
One or more fixtures do not function at all	No power to the fixture	<ul style="list-style-type: none"> Check if power is switched on and cables are plugged in
	Primary fuse blown	<ul style="list-style-type: none"> Replace fuse
Fixtures reset correctly, but all respond erratically or not at all to the controller	The controller is not connected.	<ul style="list-style-type: none"> Connect controller.
	3-pin/5-pin XLR Out of the controller does not match XLR Out of the first fixture on the link (i.e. signal is reversed)	<ul style="list-style-type: none"> Install a phase reversing cable between the controller and the first fixture on the link
Fixtures reset correctly, but some respond erratically or not at all to the controller	Poor data quality	<ul style="list-style-type: none"> Check data quality. If much lower than 100 percent, the problem may be a bad data link connection, poor quality or broken cables, missing termination plug, or a defective fixture disturbing the link
	Bad data link connection	<ul style="list-style-type: none"> Inspect connections and cables. Correct poor connections. Repair or replace damaged cables
	Data link not terminated with 120 Ohm termination plug	<ul style="list-style-type: none"> Insert termination plug in output jack of the last fixture on the link
	Incorrect addressing of the fixtures	<ul style="list-style-type: none"> Check address setting
	One of the fixtures is defective and disturbs data transmission on the link	<ul style="list-style-type: none"> Bypass one fixture at a time until normal operation is restored: unplug both connectors and connect them directly together. Have the defective fixture serviced by a qualified technician
	3-pin/5-pin XLR Out on the fixtures does not match (pins 2 and 3 reversed)	<ul style="list-style-type: none"> Install a phase-reversing cable between the fixtures or swap pin 2 and 3 in the fixture that behaves erratically
No light or lamp cuts out intermittently	Fixture is too hot	<ul style="list-style-type: none"> Allow the fixture to cool down Clean the fan Make sure air vents in control panel and the front lens are not blocked Turn up the air conditioning
	LEDs damaged	<ul style="list-style-type: none"> Disconnect the fixture and return it to your dealer
	The power supply settings do not match local AC voltage and frequency	<ul style="list-style-type: none"> Disconnect fixture. Check settings and correct if necessary

Product Specifications

Model:	Infinity iW-1915 Pixel
Input Voltage:	100-240 VAC, 60/50Hz
Power consumption:	675W (full output)
DMX linking:	30pcs
Fuse:	F7AL/250V
Dimensions:	355 x 300 x 455 mm (LxWxH)
Weight:	14,28 kg
Operating and Programming:	
Signal pin OUT:	Pin 1 (earth), pin 2 (-), pin 3 (+)
DMX Mode:	21, 97, 76+14 channels
Signal input:	3-pin/5-pin XLR IN
Signal output:	3-pin/5-pin XLR OUT
Electro-mechanical effects:	
Light source:	19 x 15W RGBW 4-in-1 Osram Ostar
Lux @ 2 m:	36600
Color mixing:	RGBW, CMY
Color temperature:	19000K
Beam angle:	7-50°
Motorized zoom:	7-50°
Dimmer:	0-100%
Strobe:	0-20Hz
Pan:	540°
Tilt:	270°
Dimming Curves:	Linear, Square, I-Square, S-curve
Housing:	Metal & Flame retardant plastic
IP rating:	IP20
DMX control:	via standard DMX-controller
Onboard:	LCD display with gravity sensor
Control:	Stand-alone, Master/Slave, DMX-512, DMX-512+ArtNet
Connections:	Dedicated PowerCON to Schuko & Data connector
Max. ambient temperature t_a :	40°C
Max. housing temperature t_B :	80°C
Minimum distance:	
Minimum distance from flammable surfaces:	0,5 m
Minimum distance to lighted object:	1,5 m

Design and product specifications are subject to change without prior notice.



Website: www.highlite.nl

Email: service@highlite.nl

Dimensions

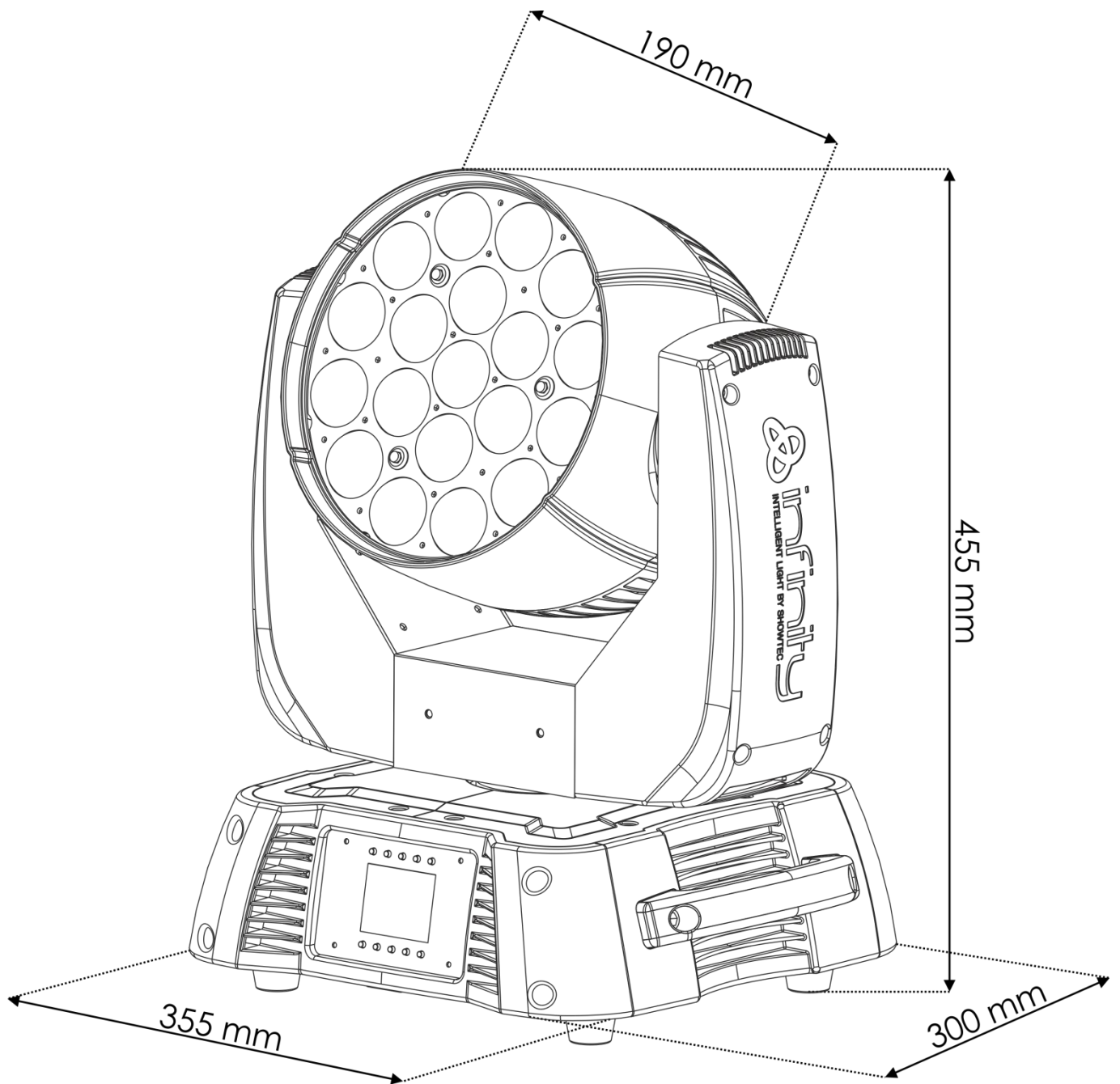



©2017 Infinity