

ENGLISH

Sunstrip LED

V1

Ordercode: 30752

Table of contents

Warning	2
Safety Instructions	2
Operating Determinations	4
Rigging	4
Connection with the mains	5
Return Procedure	6
Claims	6
Description of the device	7
Front	7
Back	8
Installation	8
Setup and Operation	8
Control Modes	9
One Sunstrip (Auto, Manual)	9
Multiple Sunstrips (Master/Slave control)	9
Multiple Sunstrips (DMX Control)	10
Fixture Linking	11
Data Cabling	11
Control Panel	12
Control Mode	12
DMX Addressing	12
Menu Overview	13
Main Menu Options	15
1. DMX Address	16
2. DMX Mode	16
3. Pixel Invert	16
4. Dimmer Mode	17
5. Dimmer Curve	17
6. Dimmer Speed	18
7. Control Mode	18
7.1. DMX Control	18
7.2. Manual Control	18
7.3. Auto Control	19
7.4. Master & Slave	19
7.5. Auto Test	19
8. Settings	20
8.1. DMX Fail	20
8.2. Display	20
8.3. Temperature	21
8.4. Fixture Hours	21
8.5. Firmware Version	21
8.6. Factory Reset	21
DMX Channels	22
1 channel	22
2 channels	22
3 channels	22
10 channels	22
20 channels	23
Maintenance	24
Replacing the Fuse	24
Troubleshooting	25
No Light	25
No Response to DMX	25
Product Specifications	27
Dimensions	28
Notes	29

Warning



**For your own safety, please read this user manual carefully
before your initial start-up!**



Unpacking Instructions

Immediately upon receiving this product, carefully unpack the carton and check the contents to ensure that all parts are present, and have been received in good condition. Notify the dealer immediately and retain packing material for inspection if any parts appear damaged from shipping or the carton itself shows signs of mishandling. Save the carton and all packing materials. In the event that a fixture must be returned to the factory, it is important that the fixture be returned in the original factory box and packing.

Your shipment includes:

- Showtec Sunstrip LED
- 2 mounting brackets incl. screws
- Pro power to Schuko power cable (1,3 m)
- User manual

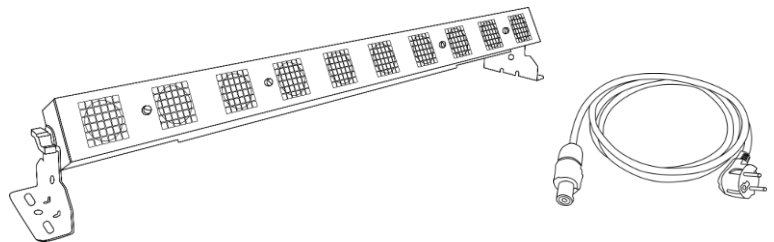

LED Expected Lifespan

LEDs gradually decline in brightness over time. HEAT is the dominant factor that leads to the acceleration of this decline. Packaged in clusters, LEDs exhibit higher operating temperatures than in ideal or singular optimum conditions. For this reason, when all color LEDs are used at their fullest intensity, life of the LEDs is significantly reduced. If improving the lifespan is of higher priority, place care in providing for lower operational temperatures. This may include climatic-environmental and the reduction of overall projection intensity.



CAUTION!

**Keep this device away from rain and moisture!
Unplug mains lead before opening the housing!**



Safety Instructions

Every person involved with the installation, operation and maintenance of this device has to:

- be qualified
- follow the instructions of this manual



**CAUTION! Be careful with your operations.
With a dangerous voltage you can suffer
a dangerous electric shock when touching the wires!**



Before the initial start-up, please make sure that there is no damage caused by transportation. Should there be any, consult your dealer and do not use the device.

To maintain perfect condition and to ensure a safe operation, it is absolutely necessary for the user to follow the safety instructions and warning notes contained in this manual.

Please consider that damages caused by manual modifications to the device are not subject to warranty.

This device contains no user-serviceable parts. Refer servicing to qualified technicians only.

IMPORTANT:

The manufacturer will not accept liability for any resulting damages caused by the non-observance of this manual or any unauthorized modification to the device.

- Never let the power cord come into contact with other cables! Handle the power cord and all connections with the mains with particular caution!
- Never modify, bend, mechanically strain, put pressure on, pull or heat up the power cord.
- Never strain the cable. There must always be sufficient cable going to the device. Otherwise, the cable will be damaged, which can cause serious damage.
- Never remove warning or informative labels from the unit.
- Never use anything to cover the ground contact.
- Never lift the device holding it by the projector-head, as the mechanics may be damaged. Always hold the device by the transport handles.
- Never place any material over the LEDs or lens.
- Never look directly into the light source.
- Never leave any cables lying around.
- Never use the device during thunderstorms, unplug the device immediately.
- Never leave various parts of the packaging (plastic bags, polystyrene foam, nails, etc.) within children's reach, as they are potential sources of danger.
- Do not insert objects into air vents.
- Do not open the device and do not modify the device.
- Do not connect this device to a dimmer pack.
- Do not switch the device on and off in short intervals, as this will reduce the device's life.
- Do not touch the device's housing bare-handed during its operation (housing becomes very hot). Allow the device to cool for at least 5 minutes before handling.
- Do not shake the device. Avoid brute force when installing or operating the device.
- Only use the device indoors, avoid contact with water or other liquids.
- Only operate the device after having checked if the housing is firmly closed and all screws are tightly fastened.
- Only operate the device after having familiarized with its functions.
- Avoid flames and do not put close to flammable liquids or gases.
- Always keep the case closed while operating.
- Always allow a free air space of at least 80 cm around the unit for ventilation.
- Always disconnect power from the mains, when device is not used or before cleaning! Only handle the power cord holding it by the plug. Never pull out the plug by tugging the power cord.
- Make sure that the device is not exposed to extreme heat, moisture or dust.
- Make sure that the available voltage is not higher than stated on the rear panel.
- Make sure that the power cord is never crimped or damaged. Check the device and the power cord from time to time.
- Make sure that the core diameter of extension cords and power cords is sufficient for the required power consumption of the device.
- If the lens or LEDs are obviously damaged, they need to be replaced to prevent their functions from being impaired, due to cracks or deep scratches.
- If the external cable is damaged, it has to be replaced by a qualified technician.
- If device was dropped or struck, disconnect mains power supply immediately. Have a qualified engineer inspect for safety before operating.
- If device has been exposed to drastic temperature fluctuation (e.g. after transportation), do not switch it on immediately. The arising condensation water might damage your device. Leave the device switched off until it has reached room temperature.
- If your Showtec device fails to work properly, discontinue the use immediately. Pack the unit securely (preferably in the original packing material), and return it to your Showtec dealer for service.
- For adult use only. The device must be installed beyond the reach of children. Never leave the unit running unattended.
- Never attempt to bypass the thermostatic switch or fuses.
- For replacement use fuses of same type and rating only.
- The user is responsible for correct positioning and operating of the device. The manufacturer will not accept liability for damages caused by the misuse or incorrect installation of this device.
- This device falls under protection class I. Therefore it is essential to connect the yellow/green conductor to earth.

- Repairs, servicing and electric connection must be carried out by a qualified technician.
- WARRANTY: Till one year after date of purchase.

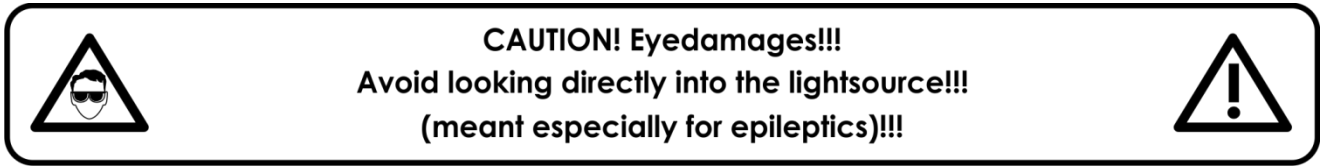

Operating Determinations

- This device is not designed for permanent operation. Consistent operation breaks will ensure that the device will serve you for a long time without defects.
- The minimum distance between light output and the illuminated surface must be bigger than 80 cm meter.
- To eliminate wear and improve lifespan, during periods of non-use, completely disconnect from power via breaker or by unplugging.
- The maximum ambient temperature $t_a = 40\text{ °C}$ must never be exceeded.
- The relative humidity must not exceed 50 % with an ambient temperature of 40 °C.
- If this device is operated in any other way than the one described in this manual, the product may suffer damages and the warranty becomes void.
- Any other operation may lead to dangers like short-circuit, burns, electric shock, crash, etc.

You endanger your own safety and the safety of others!

Rigging

Please follow the European and national guidelines concerning rigging, trussing and all other safety issues.

Do not attempt the installation yourself !

Always let the installation be carried out by an authorized dealer !

Procedure:

- If the Sunstrip is lowered from the ceiling or high joists, professional trussing systems have to be used.
- Use a clamp to mount the Sunstrip with the mounting bracket, to the trussing system.
- The Sunstrip must never be fixed swinging freely in the room.
- The installation must always be secured with a safety attachment, e.g. an appropriate safety net or safety cable.
- When rigging, derigging or servicing the Sunstrip, always make sure, that the area below the installation site is secured and that there are not any unauthorized people around.

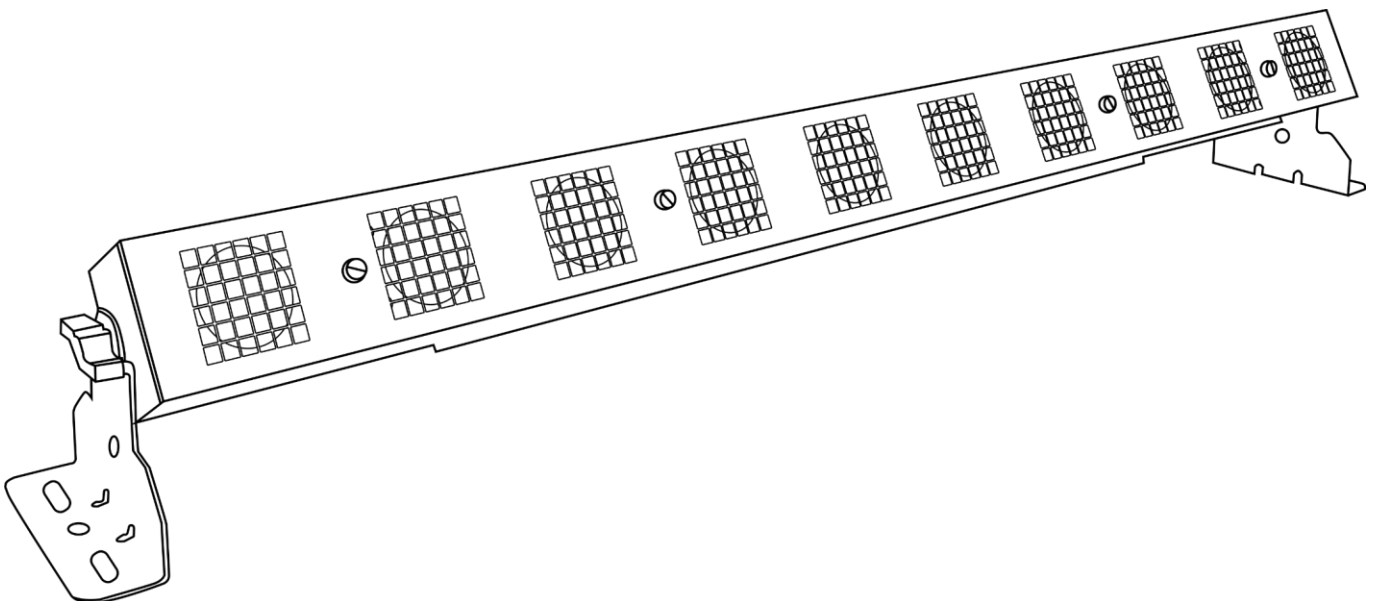

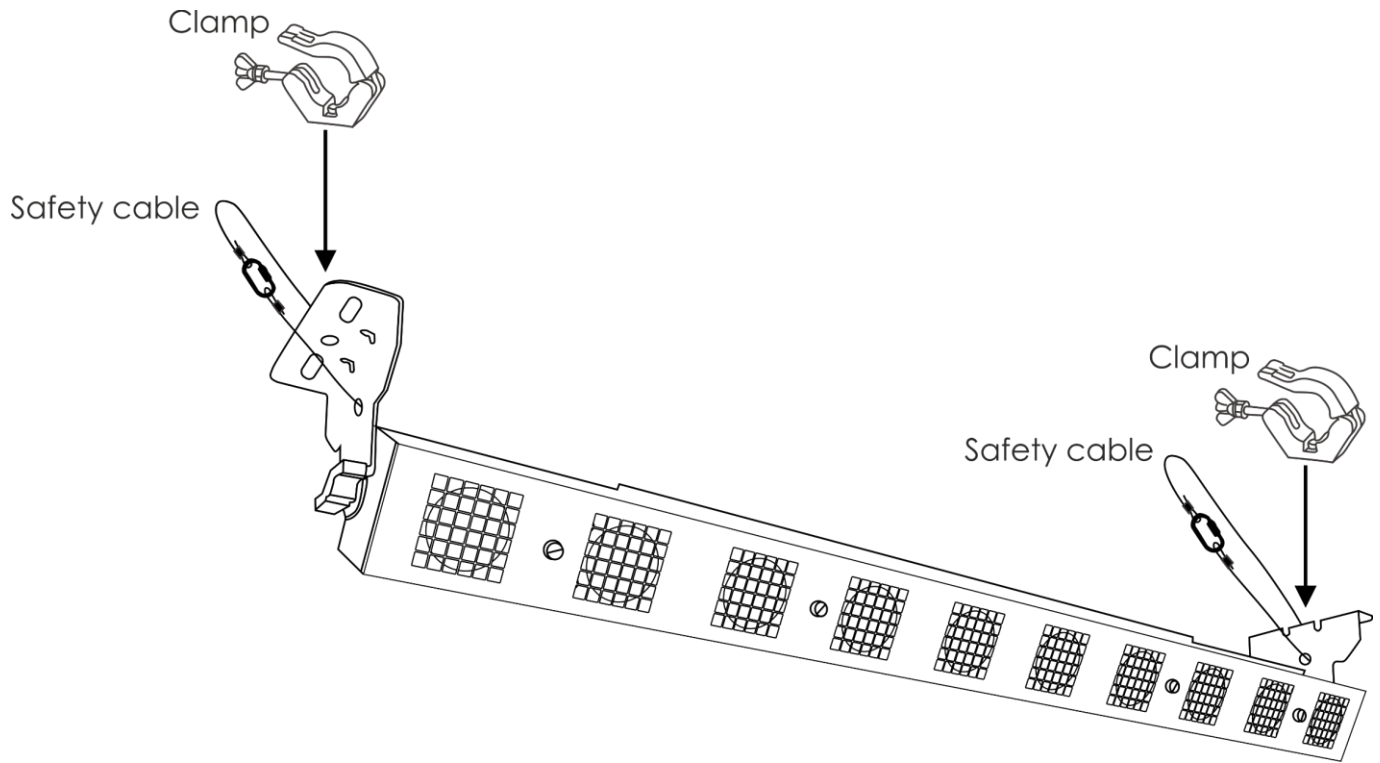

The Sunstrip LED can be placed on a flat stage floor or mounted to any kind of truss with clamps.

Improper installation can cause serious injuries and/or damage of property!

Connection with the mains

Connect the device to the mains with the power-plug.

Always check if the right color cable is connected to the right place.

International	EU Cable	UK Cable	US Cable	Pin
L	BROWN	RED	YELLOW/COPPER	PHASE
N	BLUE	BLACK	SILVER	NEUTRAL
⊕	YELLOW/GREEN	GREEN	GREEN	PROTECTIVE GROUND

Make sure that the device is always properly connected to the earth!

Improper installation can cause serious injuries and/or damage of property!



Return Procedure

Returned merchandise must be sent prepaid and in the original packing, call tags will not be issued. Package must be clearly labeled with a Return Authorization Number (RMA number). Products returned without an RMA number will be refused. Highlite will not accept the returned goods or any responsibility. Call Highlite 0031-455667723 or mail offersales@highlite.com and request an RMA prior to shipping the fixture. Be prepared to provide the model number, serial number and a brief description of the cause for the return. Be sure to properly pack fixture, any shipping damage resulting from inadequate packaging is the customer's responsibility. Highlite reserves the right to use its own discretion to repair or replace product(s). As a suggestion, proper UPS packing or double-boxing is always a safe method to use.

Note: If you are given an RMA number, please include the following information on a piece of paper inside the box:

- 01) Your name
- 02) Your address
- 03) Your phone number
- 04) A brief description of the symptoms

Claims

The client has the obligation to check the delivered goods immediately upon delivery for any shortcomings and/or visible defects, or perform this check after our announcement that the goods are at their disposal. Damage incurred in shipping is the responsibility of the shipper; therefore the damage must be reported to the carrier upon receipt of merchandise.

It is the customer's responsibility to report and submit claims with the shipper in the event that a fixture is damaged due to shipping. Transportation damage has to be reported to us within one day after receipt of the delivery.

Any return shipment has to be made post-paid at all times. Return shipments must be accompanied with a letter defining the reason for return shipment. Non-prepaid return shipments will be refused, unless agreed otherwise in writing.

Complaints against us must be prepared in writing or sent by fax within 10 working days after receipt of the invoice. After this period complaints will not be handled anymore.

Complaints will only then be considered if the client has so far complied with all parts of the agreement, regardless of the agreement from which the obligation is resulting.

Description of the device

Features

The Sunstrip LED is the successor of the already popular Sunstrip Active. Thanks to Tungsten mode, the Sunstrip LED works like conventional bulbs while it is still possible to operate it in Warm white, Cool white or in a combination of both.

- Input voltage: 110–240 V AC, 50/60 Hz
- Power consumption: 120 W
- Light source: 10 x 14W (Warm/Cool Prolight Opto)
- Control modes: Auto, Manual, Master/Slave, DMX
- DMX channels: 1, 2, 3, 10, 20 channels
- OLED display for easy setup
- Control protocol: DMX-512
- Dimmer: 0–100 %
- Strobe: 0–20 Hz
- IP rating: IP20
- Power connector: Pro power connector IN/OUT
- Data connector: 3-pin/5-pin XLR IN/OUT
- Fuse: T2AL/250V
- Dimensions: 1085 x 146 x 166 mm (LxWxH) (incl. brackets)
- Weight: 7 kg

Note: Knowledge of DMX is required to fully utilize this unit.

Optional accessories

[D7039](#) – Case for 12 x Sunstrip Active

[D7240](#) – Case for 8 x Sunstrip Active (Premium Line)

[D7510](#) – Case for 8 x Sunstrip Active

Front

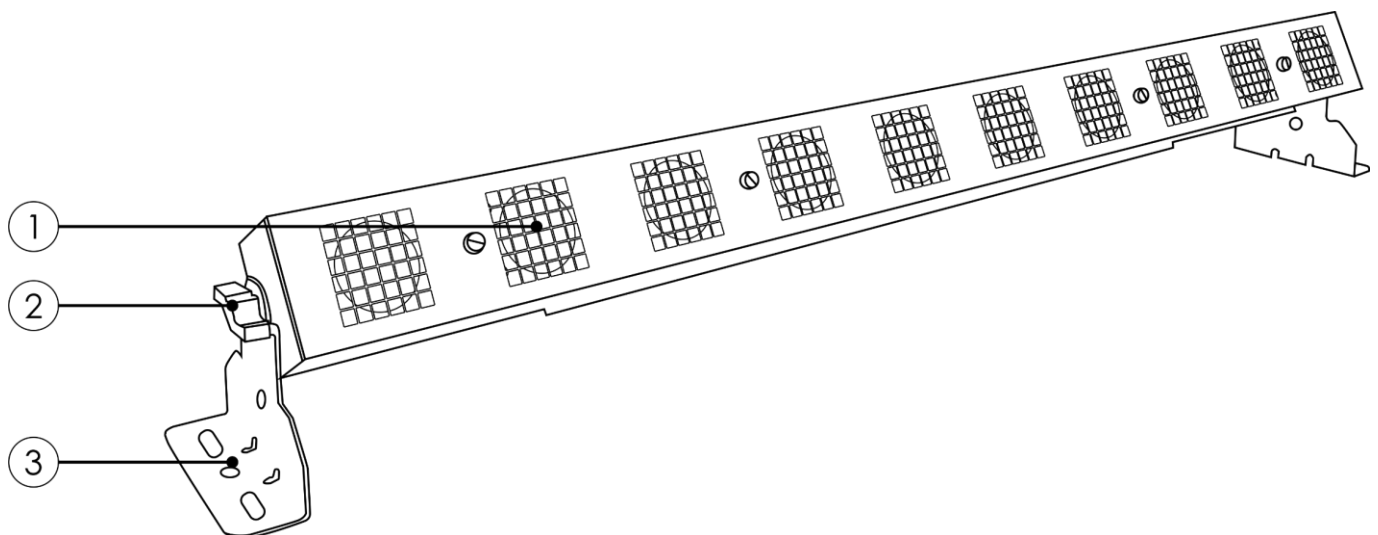

Fig. 01

- 01) 10 x 14 W (Warm/Cool Prolight Opto)
- 02) Adjustment screw
- 03) Mounting bracket

Back

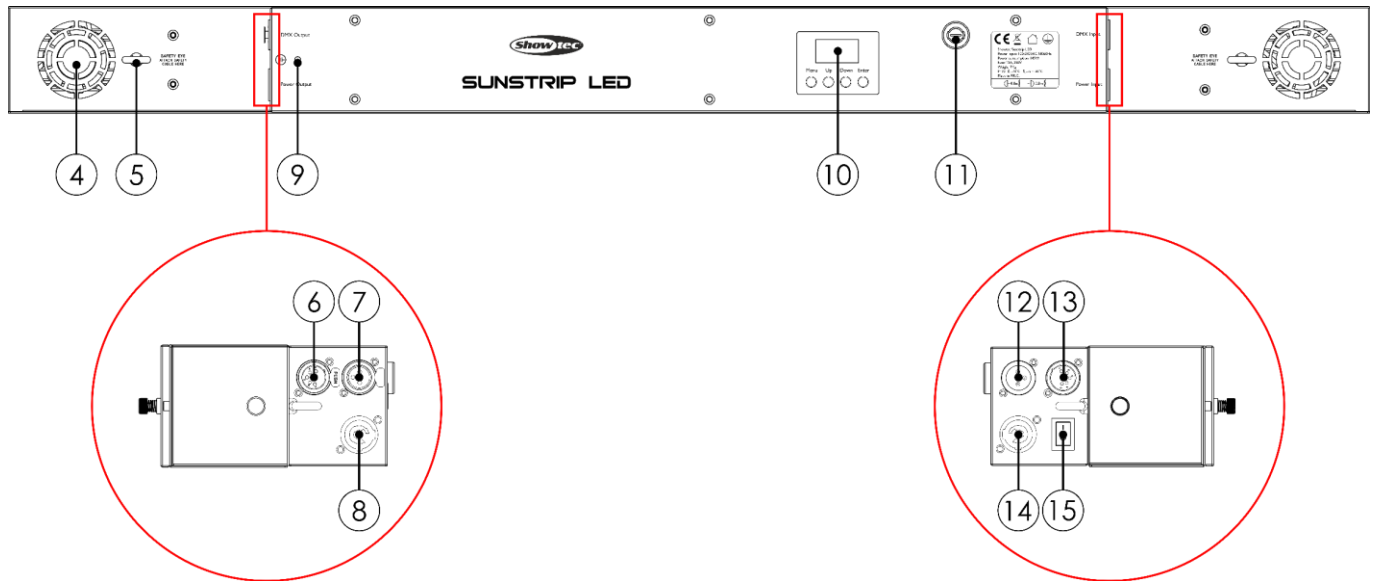

Fig. 02

- 04) Cooling fan
- 05) Safety eye
- 06) 5-pin DMX signal connector OUT
- 07) 3-pin DMX signal connector OUT
- 08) Pro power connector Gray OUT
- 09) Ground/earth connection
- 10) OLED display + control buttons
- 11) Fuse T2AL/250V
- 12) 3-pin DMX signal connector IN
- 13) 5-pin DMX signal connector IN
- 14) Pro power connector Blue IN
- 15) Power switch ON/OFF

Installation

Remove all packing materials from the Sunstrip LED. Check if all foam and plastic padding is removed. Connect all cables.

Do not supply power before the whole system is set up and connected properly.

Always disconnect from electric mains power supply before cleaning or servicing.

Damages caused by non-observance are not subject to warranty.

Setup and Operation

Follow the directions below, as they pertain to your preferred operation mode.

Before plugging the unit in, always make sure that the power supply matches the product specification voltage. Do not attempt to operate a 110 V specification product on 240 V power, or vice versa.

Connect the device to the main power supply.

Control Modes

There are 4 modes:

- Auto
- Manual
- Master/Slave
- DMX-512 (1CH, 2CH, 3CH, 10CH, 20CH)

One Sunstrip (Auto, Manual)

- 01) Fasten the effect light to a firm trussing. Leave at least 0,8 meter on all sides for air circulation.
- 02) Always use a safety cable (ordercode 70140 / 70141).
- 03) Plug the end of the electric mains power cord into a proper electric power supply socket.
- 04) When the Sunstrip is not connected with a DMX cable, it functions as a stand-alone device. Please see pages 18–19 for more information about Auto mode and Manual mode.

Multiple Sunstrips (Master/Slave control)

- 01) Fasten the effect light onto firm trussing. Leave at least 0,8 meter on all sides for air circulation.
- 02) Always use a safety cable (ordercode 70140 / 70141).
- 03) Use a 3-pin/5-pin XLR cable to connect the Sunstrip.

The pins:



- 01) Earth
- 02) Signal –
- 03) Signal +



- 01) Earth
- 02) Signal –
- 03) Signal +
- 04) N/C
- 05) N/C

- 04) Link the units as shown in fig. 03. Connect the first unit's DMX "out" socket with the second unit's "in" socket, using a DMX signal cable. Repeat this process to link the second, third and fourth units. You can use the same functions on the master device as described on page 18–19 (Auto mode, Manual mode). This means that you can set your desired operation mode on the master device and all slave devices will react the same as the master device.

Multiple Sunstrips (Master/Slave control)

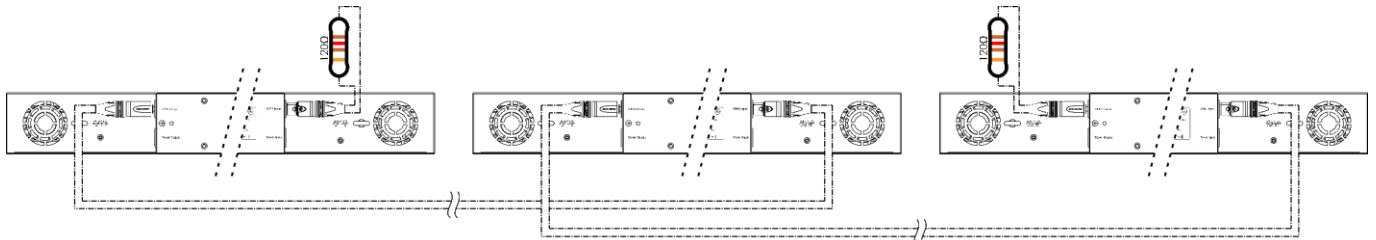
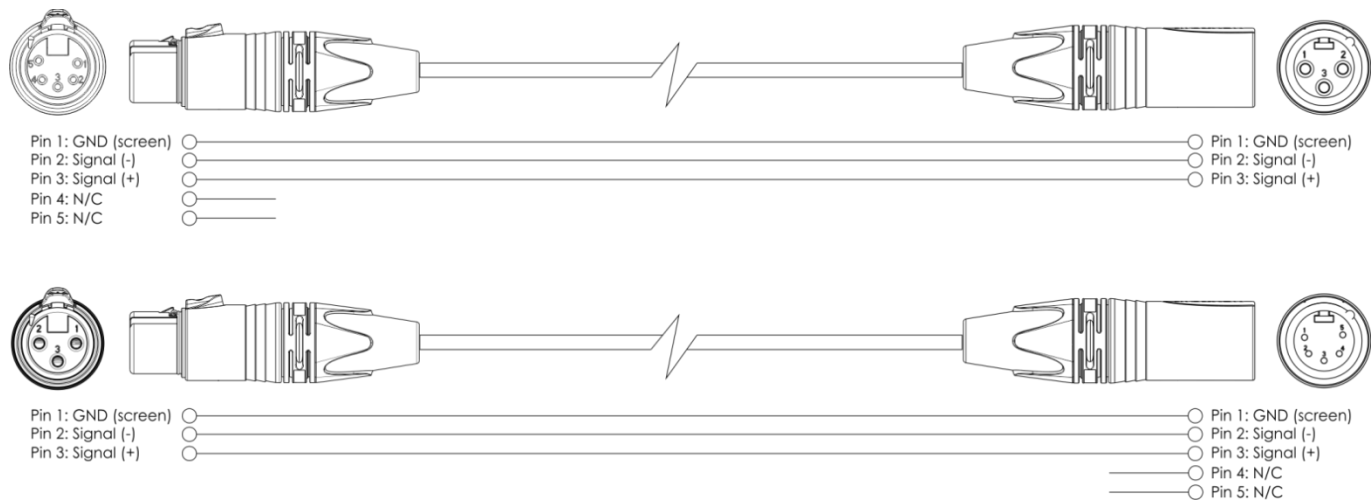

Fig. 03

Multiple Sunstrips (DMX Control)

- 01) Fasten the effect light to a firm trussing. Leave at least 0,8 meter on all sides for air circulation.
- 02) Always use a safety cable (ordercode 70140 / 70141).
- 03) Use a 3-pin/5-pin XLR cable to connect the Sunstrips and other devices.



- 04) Link the units as shown in fig. 04. Connect the first unit's DMX "out" socket with the second unit's "in" socket, using a DMX signal cable. Repeat this process to link the second, third and fourth units.
- 05) Supply electric power: Plug electric mains power cords into each unit's Pro power socket, then plug the other end of the mains power cord into proper electric power supply sockets, starting with the first unit. Do not supply power before the whole system is set up and connected properly.

Multiple Sunstrips DMX Setup

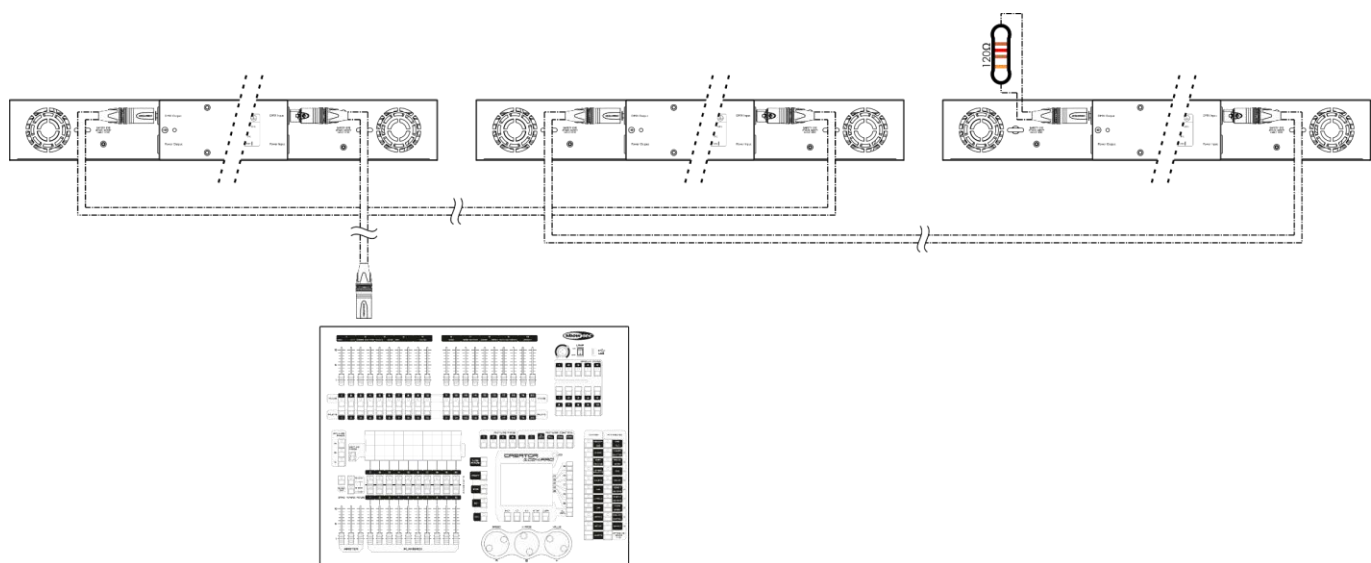



Fig. 04

Note : Link all cables before connecting electric power

Fixture Linking

You will need a serial data link to run light shows of one or more fixtures using a DMX-512 controller or to run synchronized shows of two or more fixtures set to a master/slave operating mode. The combined number of channels required by all the fixtures on a serial data link determines the number of fixtures the data link can support.

Important: Fixtures on a serial data link must be daisy-chained in a single line. To comply with the EIA-485 standard, no more than 30 devices should be connected on one data link. Connecting more than 30 fixtures on one serial data link without the use of a DMX optically isolated splitter may result in deterioration of the digital DMX signal.

 Maximum recommended DMX data link distance: 100 meters
Maximum recommended number of fixtures on a DMX data link: 30 fixtures
Maximum recommended number of fixtures on a power link @ 110V: 14 fixtures
Maximum recommended number of fixtures on a power link @ 240V: 28 fixtures

Data Cabling

To link fixtures together, you must obtain data cables. You can purchase DAP Audio certified DMX cables directly from a dealer/distributor or construct your own cable. If you choose to create your own cable, please use data-grade cables that can carry a high quality signal and are less prone to electromagnetic interference.

DAP Audio DMX Data Cables

- DAP Audio Basic microphone cable for allround use. bal. XLR/M 3-pin > XLR/F 3-pin. **Ordercode** FL01150 (1,5 m), FL013 (3 m), FL016 (6 m), FL0110 (10 m), FL0115 (15 m), FL0120 (20 m).
- DAP Audio X-type data cable XLR/M 3-pin > XLR/F 3-pin. **Ordercode** FLX0175 (0,75 m), FLX01150 (1,5 m), FLX013 (3 m), FLX016 (6 m), FLX0110 (10 m).
- DAP Audio cable for the demanding user with exceptional audio-qualities and connector made by Neutrik®. **Ordercode** FL71150 (1,5 m), FL713 (3 m), FL716 (6 m), FL7110 (10 m).
- DAP Audio cable for the demanding user with exceptional audio-qualities and connector made by Neutrik®. **Ordercode** FL7275 (0,75 m), FL72150 (1,5 m), FL723 (3 m), FL726 (6 m), FL7210 (10 m).
- DAP Audio 110 Ohm cable with digital signal transmission. **Ordercode** FL0975 (0,75 m), FL09150 (1,5 m), FL093 (3 m), FL096 (6 m), FL0910 (10 m), FL0915 (15 m), FL0920 (20 m).
- DAP Audio data cable FL08 DMX/AES-EBU, XLR/M 5-pin > XLR/F 5-pin. **Ordercode** FL08150 (1,5 m), FL083 (3 m), FL086 (6 m), FL0810 (10 m), FL0820 (20 m).
- DAP Audio DMX adapter: 5-pin/3-pin. **Ordercode** FLA29.
- DAP Audio DMX adapter: 3-pin/5-pin. **Ordercode** FLA30.
- DAP Audio DMX Terminator 3-pin. **Ordercode** FLA42.
- DAP Audio DMX Terminator 5-pin. **Ordercode** FLA43.

The Sunstrip LED can be operated with a controller in **control mode** or without the controller in **stand-alone mode**.

Control Panel

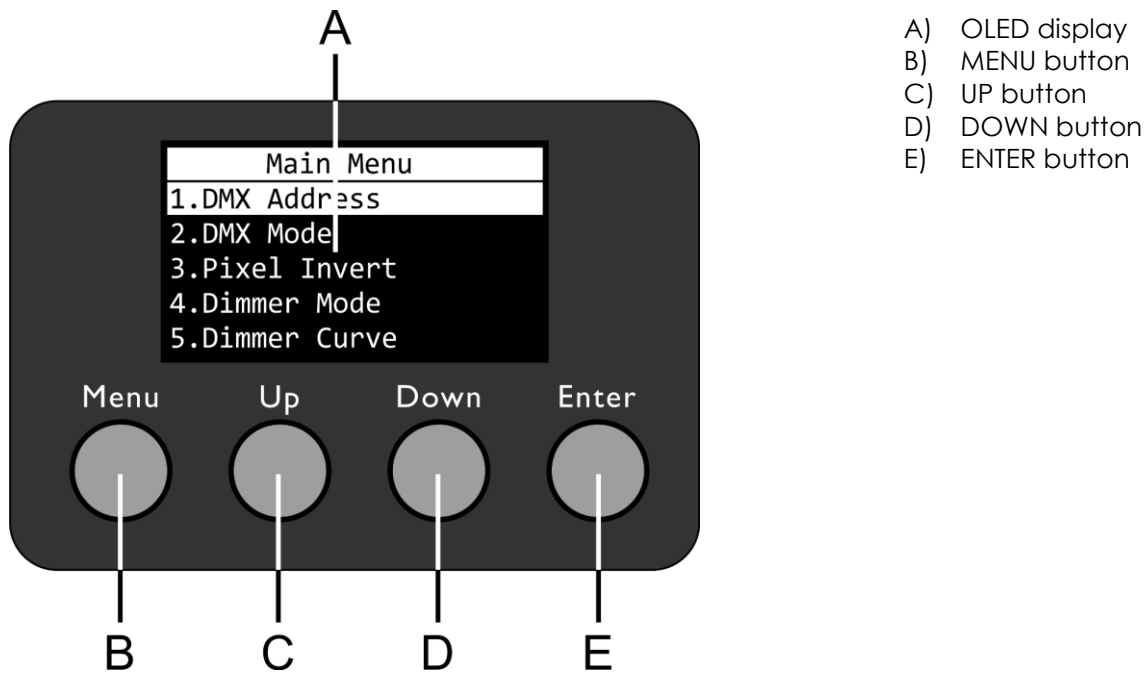

Fig. 05

Control Mode

The fixtures are individually addressed on a data-link and connected to the controller. The fixtures respond to the DMX signal from the controller. (When you select the DMX address and save it, the controller will display the saved DMX address, next time.)

DMX Addressing

The control panel on the back side of the device allows you to assign DMX fixture addresses, which is the first channel with which the Sunstrip will respond to the controller.

Please note, when you use the controller, the unit has **20** channels.

When using multiple Sunstrips, make sure you set the DMX addresses right.

Therefore, the DMX address of the first Sunstrip should be **1(001)**; the DMX address of the second Sunstrip should be **1+20=21 (021)**; the DMX address of the third Sunstrip should be **21+20=41 (041)**, etc. Please, be sure that you do not have any overlapping channels in order to control each Sunstrip correctly. If two or more Sunstrips are addressed similarly, they will work similarly.

Controlling:

After having addressed all Sunstrips, you may now start operating these via your lighting controller.

Note: After switching on, the Sunstrip will automatically detect whether DMX 512 data is received or not. If there is no data received at the DMX input, the "LED" on the control panel will not flash.

If not, the problem may be:

- The XLR cable from the controller is not connected with the input of the Sunstrip.
- The controller is switched off or defective, the cable or connector is defective, or the signal wires are swapped in the input connector.

Note: It is necessary to insert an XLR termination plug (with 120 Ohm) in the last fixture in order to ensure proper transmission on the DMX data link.

⚠ Display Off after 60 seconds ⚠

The display turns off after 60 seconds of inactivity. See **8.2. Display** on page 20 for further information. Press the MENU, UP, DOWN or ENTER button to light up the display.

Menu Overview

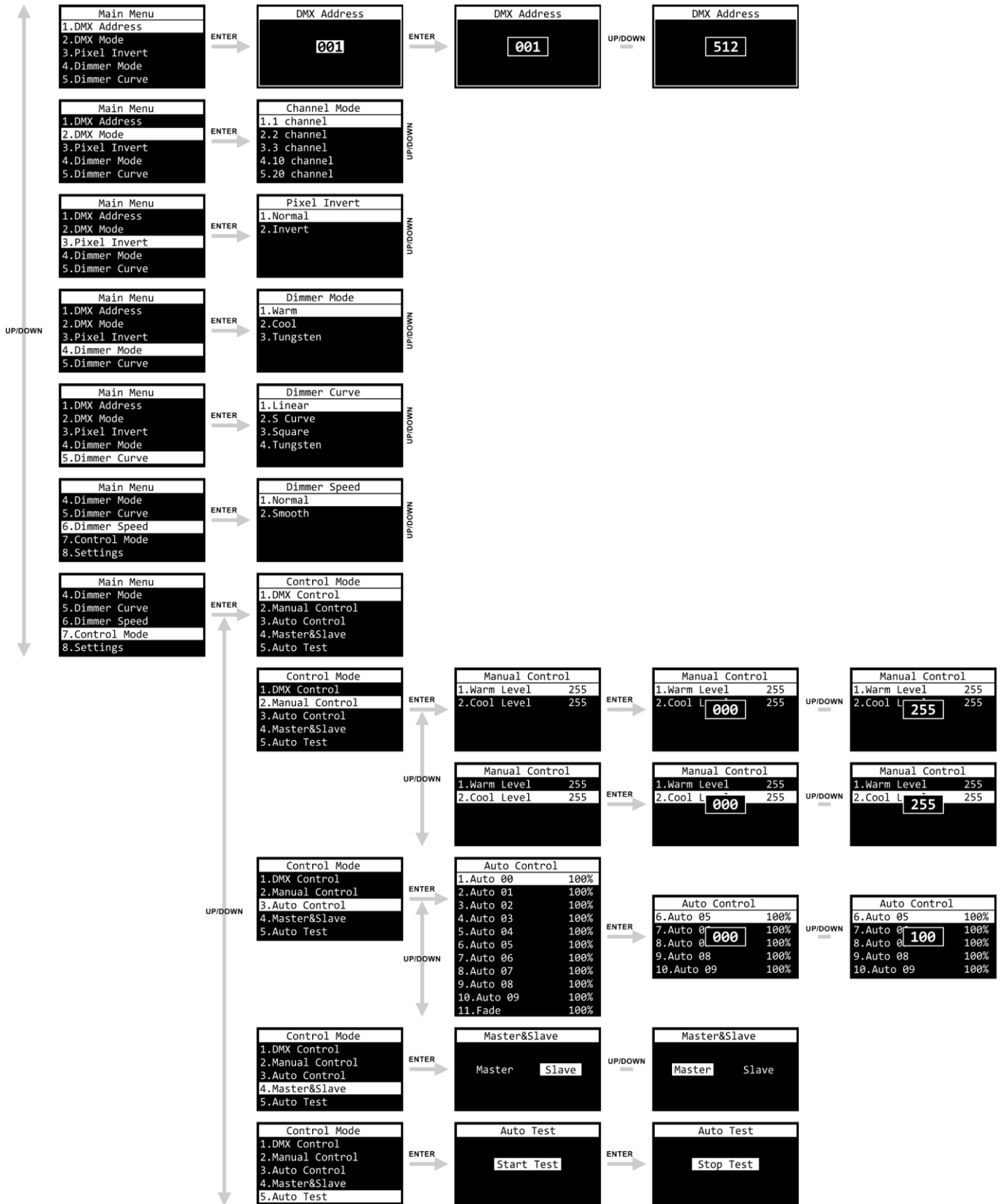

Main Menu Options

01) Upon start-up, the display will show the current version of the device.



02) After 3 seconds, the display will show the current device status.

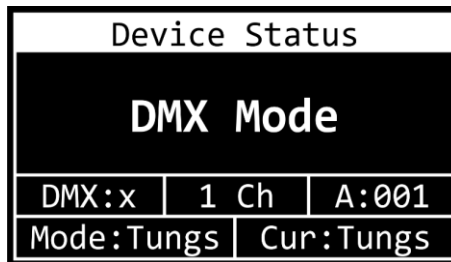

03) You can now view whether or not the Sunstrip receives a DMX signal. You can also view the currently selected operation mode, the DMX starting address, the dimmer mode and the dimming curve type.

04) Press the **MENU** button to open the main menu. The display will show:

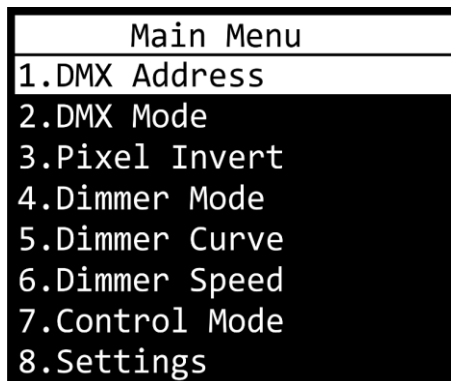

05) Press the **UP/DOWN** buttons to toggle through the 8 menus.

06) Press the **ENTER** button to open the desired menu.

1. DMX Address

In this menu you can set the desired DMX starting address.

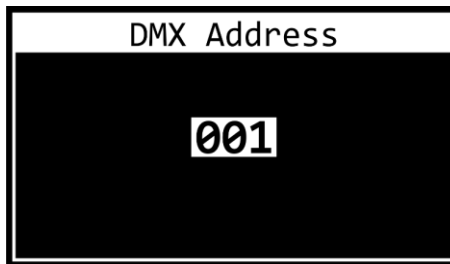

01) Press the **ENTER** button to open the menu. The display will show:

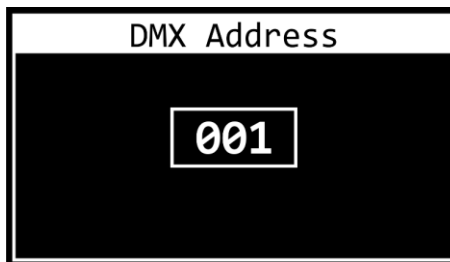

02) Press the **UP/DOWN** buttons to set the desired DMX address. The adjustment range is between 001–512.

03) Press the **ENTER** button to confirm.

2. DMX Mode

In this menu you can set the desired DMX channel mode.

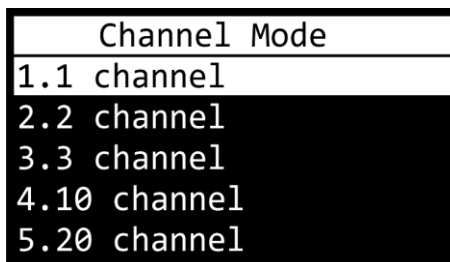

01) Press the **UP/DOWN** buttons to choose one of the 5 DMX channel modes:

- 1-channel mode
- 2-channel mode
- 3-channel mode
- 10-channel mode
- 20-channel mode

02) Press the **ENTER** button to confirm.

3. Pixel Invert

In this menu you can set the pixel direction.

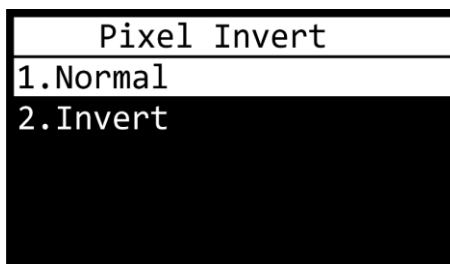

01) Press the **UP/DOWN** buttons to select NORMAL or INVERT.

02) Press the **ENTER** button to confirm.

4. Dimmer Mode

In this menu you can set the dimmer mode.

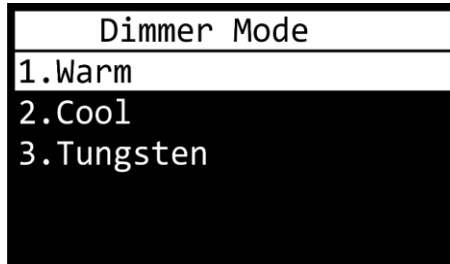

01) Press the **UP/DOWN** buttons to choose one of the 3 dimmer modes:

- WARM
- COOL
- TUNGSTEN

02) Press the **ENTER** button to confirm.

5. Dimmer Curve

In this menu you can set the dimming curves.

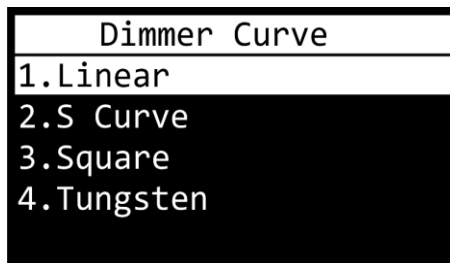

01) Press the **UP/DOWN** buttons to choose one of the 4 dimming curves:

- LINEAR
- S-CURVE
- SQUARE
- TUNGSTEN

02) Press the **ENTER** button to confirm.

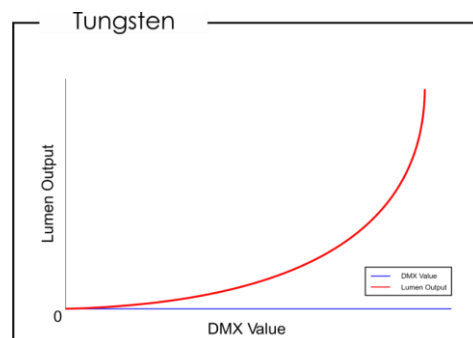
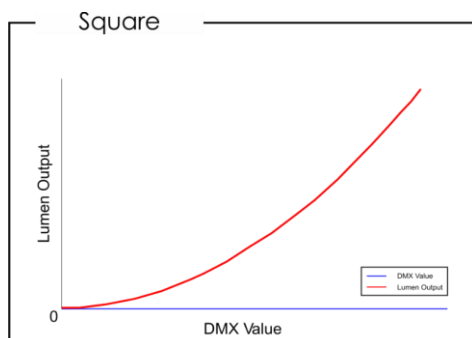
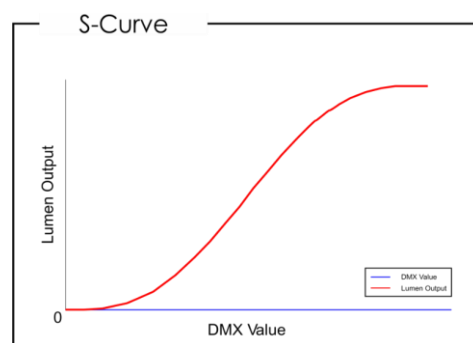
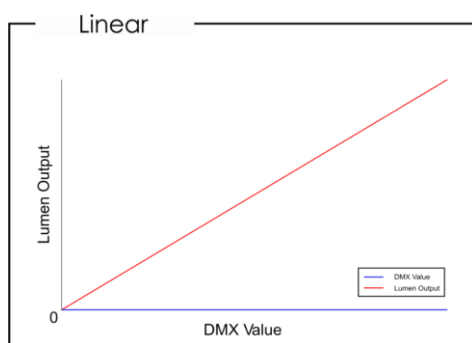

6. Dimmer Speed

In this menu you can set the dimmer speed.

Dimmer Speed	
1.	Normal
2.	Smooth

01) Press the **UP/DOWN** buttons to choose one of the 2 dimmer speeds:

- NORMAL
- SMOOTH

02) Press the **ENTER** button to confirm.

7. Control Mode

In this menu you can set the desired control mode.

Control Mode	
1.	DMX Control
2.	Manual Control
3.	Auto Control
4.	Master&Slave
5.	Auto Test

01) Press the **UP/DOWN** buttons to choose one of the 5 control modes:

- DMX CONTROL
- MANUAL CONTROL
- AUTO CONTROL
- MASTER & SLAVE
- AUTO TEST

02) Press the **ENTER** button to confirm.

7.1. DMX Control

In this menu you can control the Sunstrip with a DMX controller.

01) Press the **ENTER** button to confirm.

7.2. Manual Control

In this menu you can set levels of Cool and Warm.

Manual Control		
1.	Warm Level	255
2.	Cool Level	255

01) Press the **UP/DOWN** buttons to choose one of the 2 options:

- WARM LEVEL
- COOL LEVEL

02) Press the **ENTER** button to confirm.

03) Press the **UP/DOWN** buttons to set the intensity of cool or warm light. The adjustment range is between 0–255, from dark to brightest.

7.3. Auto Control

In this menu you can set the built-in programs and a fade.

Auto Control	
1.Auto 00	100%
2.Auto 01	100%
3.Auto 02	100%
4.Auto 03	100%
5.Auto 04	100%
6.Auto 05	100%
7.Auto 06	100%
8.Auto 07	100%
9.Auto 08	100%
10.Auto 09	100%
11.Fade	100%

- 01) Press the **UP/DOWN** buttons to choose one of the 10 built-in programs or the fade.
- 02) Press the **ENTER** button to confirm.
- 03) Press the **UP/DOWN** buttons to set the program speed. The adjustment range is between 0–100%, from slow to fast.
- 04) Press the **ENTER** button to confirm.

7.4. Master & Slave

In this menu you can set the device as a master or a slave.

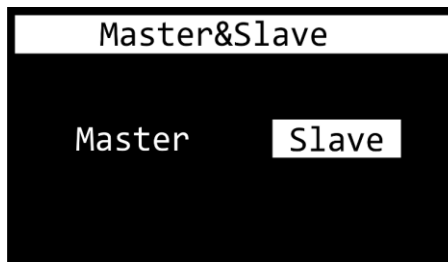

- 01) Press the **UP/DOWN** buttons to choose MASTER or SLAVE.
- 02) Press the **ENTER** button to confirm.
- 03) If you have chosen MASTER, the device will send DMX signals to the connected slave devices.
- 04) If you have chosen SLAVE, the device will receive DMX signals from the master device and will react the same as the master device.

7.5. Auto Test

In this menu, the device will run a function test.

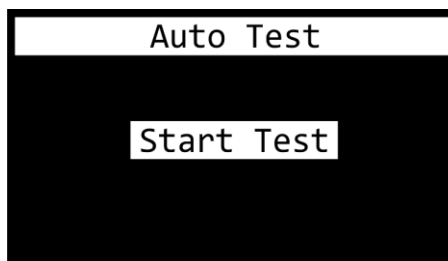

- 01) Press the **ENTER** button to start the test.
- 02) Press the **ENTER** button again, to stop the test.

8. Settings

In this menu you can adjust the device's settings.

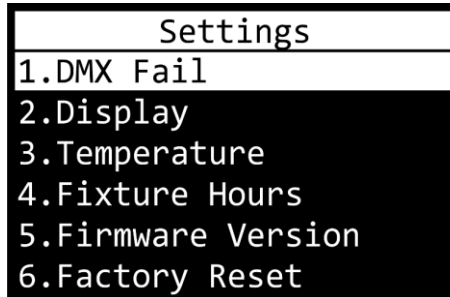

01) Press the **UP/DOWN** buttons to choose one of the 6 submenus:

- DMX FAIL
- DISPLAY
- TEMPERATURE
- FIXTURE HOURS
- FIRMWARE VERSION
- FACTORY RESET

02) Press the **ENTER** button to confirm.

8.1. DMX Fail

In this menu you can set the device's behavior in case of a DMX failure.

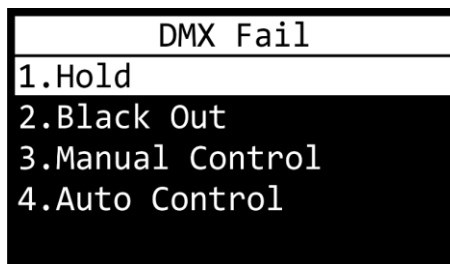

01) Press the **UP/DOWN** buttons to choose one of the 4 options:

- HOLD: The device will use last properly received DMX signal, ensuring uninterrupted performance.
- BLACK OUT: The device will black out the light output.
- MANUAL CONTROL: The device will switch to Manual mode.
- AUTO CONTROL: The device will run the built-in programs.

02) Press the **ENTER** button to confirm.

8.2. Display

In this menu you can adjust the display settings.



01) Press the **UP/DOWN** buttons to choose one of the 2 options:

- MODE: Choose NORMAL (normal view) or INVERTED (inverted display).
- BACKLIGHT(s): The time that needs to pass before the display turns off, when no buttons are pressed. Choose 15, 30, 60 seconds or ON (display continuously on).

02) Press the **ENTER** button to confirm.

- 03) Press the **UP/DOWN** buttons to change values.
- 04) Press the **ENTER** button to confirm.

8.3. Temperature

In this menu you can view the device's temperature.

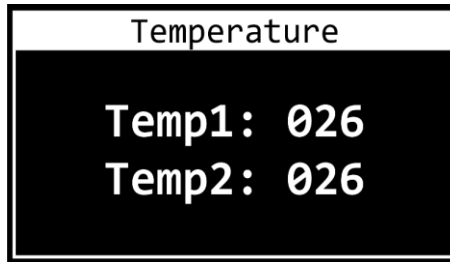

8.4. Fixture Hours

In this menu you can view the device's total operation hours.

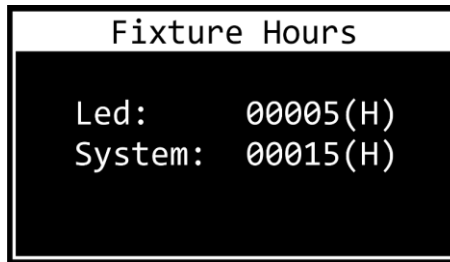

8.5. Firmware Version

In this menu you can view the currently installed software version.

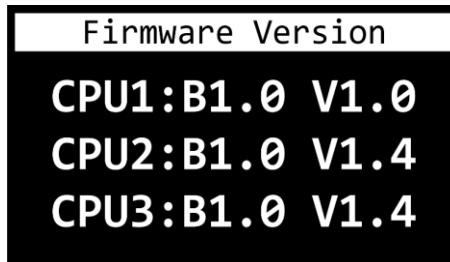

8.6. Factory Reset

In this menu you can restore the default factory settings.

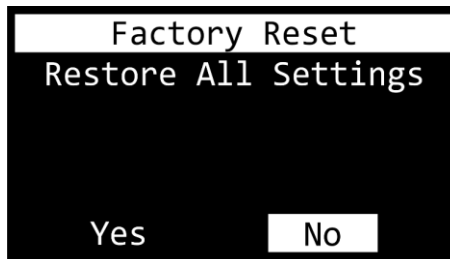

- 01) Press the **UP/DOWN** buttons to choose YES or NO.
- 02) Press the **ENTER** button to confirm.

DMX Channels**1 channel****Channel 1 – Dimmer intensity (All LEDs)**

0-255 Gradual adjustment, from dark to brightest 0-100%

2 channels**Channel 1 – Dimmer intensity Warm (All LEDs)**

0-255 Gradual adjustment, from dark to brightest 0-100%

Channel 2 – Dimmer intensity Cool (All LEDs)

0-255 Gradual adjustment, from dark to brightest 0-100%

3 channels**Channel 1 – Dimmer intensity Warm (All LEDs)**

0-255 Gradual adjustment, from dark to brightest 0-100%

Channel 2 – CTC (All LEDs) ⚠ CH1 must be open ⚠

0-255 Gradual adjustment, from Warm to Cool

Channel 3 – Strobe (All LEDs) ⚠ CH1-2 must be open ⚠

0-10 Not functional

11-255 Strobe frequency, from low to high frequency

10 channels**Channel 1 – Dimmer intensity (LED 1)**

0-255 Gradual adjustment, from dark to brightest 0-100%

Channel 2 – Dimmer intensity (LED 2)

0-255 Gradual adjustment, from dark to brightest 0-100%

Channel 3 – Dimmer intensity (LED 3)

0-255 Gradual adjustment, from dark to brightest 0-100%

Channel 4 – Dimmer intensity (LED 4)

0-255 Gradual adjustment, from dark to brightest 0-100%

Channel 5 – Dimmer intensity (LED 5)

0-255 Gradual adjustment, from dark to brightest 0-100%

Channel 6 – Dimmer intensity (LED 6)

0-255 Gradual adjustment, from dark to brightest 0-100%

Channel 7 – Dimmer intensity (LED 7)

0-255 Gradual adjustment, from dark to brightest 0-100%

Channel 8 – Dimmer intensity (LED 8)

0-255 Gradual adjustment, from dark to brightest 0-100%

Channel 9 – Dimmer intensity (LED 9)

0-255 Gradual adjustment, from dark to brightest 0-100%

Channel 10 – Dimmer intensity (LED 10)

0-255 Gradual adjustment, from dark to brightest 0-100%

20 channels**Channel 1 – Dimmer intensity Warm (LED 1)**

0-255 Gradual adjustment, from dark to brightest 0-100%

Channel 2 – Dimmer intensity Cool (LED 1)

0-255 Gradual adjustment, from dark to brightest 0-100%

Channel 3 – Dimmer intensity Warm (LED 2)

0-255 Gradual adjustment, from dark to brightest 0-100%

Channel 4 – Dimmer intensity Cool (LED 2)

0-255 Gradual adjustment, from dark to brightest 0-100%

Channel 5 – Dimmer intensity Warm (LED 3)

0-255 Gradual adjustment, from dark to brightest 0-100%

Channel 6 – Dimmer intensity Cool (LED 3)

0-255 Gradual adjustment, from dark to brightest 0-100%

Channel 7 – Dimmer intensity Warm (LED 4)

0-255 Gradual adjustment, from dark to brightest 0-100%

Channel 8 – Dimmer intensity Cool (LED 4)

0-255 Gradual adjustment, from dark to brightest 0-100%

Channel 9 – Dimmer intensity Warm (LED 5)

0-255 Gradual adjustment, from dark to brightest 0-100%

Channel 10 – Dimmer intensity Cool (LED 5)

0-255 Gradual adjustment, from dark to brightest 0-100%

Channel 11 – Dimmer intensity Warm (LED 6)

0-255 Gradual adjustment, from dark to brightest 0-100%

Channel 12 – Dimmer intensity Cool (LED 6)

0-255 Gradual adjustment, from dark to brightest 0-100%

Channel 13 – Dimmer intensity Warm (LED 7)

0-255 Gradual adjustment, from dark to brightest 0-100%

Channel 14 – Dimmer intensity Cool (LED 7)

0-255 Gradual adjustment, from dark to brightest 0-100%

Channel 15 – Dimmer intensity Warm (LED 8)

0-255 Gradual adjustment, from dark to brightest 0-100%

Channel 16 – Dimmer intensity Cool (LED 8)

0-255 Gradual adjustment, from dark to brightest 0-100%

Channel 17 – Dimmer intensity Warm (LED 9)

0-255 Gradual adjustment, from dark to brightest 0-100%

Channel 18 – Dimmer intensity Cool (LED 9)

0-255 Gradual adjustment, from dark to brightest 0-100%

Channel 19 – Dimmer intensity Warm (LED 10)

0-255 Gradual adjustment, from dark to brightest 0-100%

Channel 20 – Dimmer intensity Cool (LED 10)

0-255 Gradual adjustment, from dark to brightest 0-100%

Maintenance

The operator has to make sure that safety-related and machine-technical installations are to be inspected by an expert after every year in the course of an acceptance test.

The operator has to make sure that safety-related and machine-technical installations are to be inspected by a skilled person once a year.

The following points have to be considered during the inspection:

- 01) All screws used for installing the device or parts of the device have to be tightly connected and must not be corroded.
- 02) There may not be any deformations on housings, fixations and installation spots.
- 03) Mechanically moving parts like axles, eyes and others may not show any traces of wearing.
- 04) The electric power supply cables must not show any damages or material fatigue.

The Sunstrip LED requires almost no maintenance. However, you should keep the unit clean.

Otherwise, the fixture's light output will be significantly reduced. Disconnect the mains power supply, and then wipe the cover with a damp cloth. Do not immerse in liquid. Wipe lens clean with glass cleaner and a soft cloth. Do not use alcohol or solvents.

The front lens will require weekly cleaning, as smoke-fluid tends to build up residues, reducing the light output very quickly.

Keep connections clean. Disconnect electric power, and then wipe the DMX and audio connections with a damp cloth. Make sure connections are thoroughly dry before linking equipment or supplying electric power.

Replacing the Fuse

Power surges, short-circuit or inappropriate electrical power supply may cause a fuse to burn out.

If the fuse burns out, the product will not function whatsoever. If this happens, follow the directions below:

- 01) Unplug the unit from electric power source.
- 02) Insert a flat-headed screwdriver into a slot in the fuse cover. Turn the screwdriver to the left, at the same time gently push a bit (Turn and Push). The fuse will come out.
- 03) Remove the used fuse. If brown or unclear, it is burned out.
- 04) Insert the replacement fuse into the holder. Reinsert the fuse cover. Be sure to use a fuse of the same type and specification. See the product specification label for details.

Troubleshooting

This troubleshooting guide is meant to help solve simple problems.

If a problem occurs, carry out the steps below in sequence until a solution is found. Once the unit operates properly, do not carry out following steps.

No Light

If the light effect does not operate properly, refer servicing to a technician.

Suspect three potential problem areas as: the power supply, the LEDs, the fuse.

- 01) Power supply. Check if the unit is plugged into an appropriate power supply.
- 02) The LEDs. Return the Sunstrip to your Showtec dealer.
- 03) The fuse. Replace the fuse. See page 24 for replacing the fuse.
- 04) If all of the above appears to be O.K., plug the unit in again.
- 05) If you are unable to determine the cause of the problem, do not open the Sunstrip, as this may damage the unit and the warranty will become void.
- 06) Return the device to your Showtec dealer.

No Response to DMX

Suspect the DMX cable or connectors, a controller malfunction, a light effect DMX card malfunction.

- 01) Check the DMX setting. Make sure that DMX addresses are correct.
- 02) Check the DMX cable: Unplug the unit; change the DMX cable; then reconnect to electrical power. Try your DMX control again.
- 03) Determine whether the controller or light effect is at fault. Does the controller operate properly with other DMX products? If not, take the controller in for repair. If so, take the DMX cable and the light effect to a qualified technician.

Problem	Probable cause(s)	Remedy
One or more fixtures do not function at all.	No power to the fixture.	<ul style="list-style-type: none"> • Check if power is switched on and cables are plugged in.
	Primary fuse blown.	<ul style="list-style-type: none"> • Replace fuse.
Fixtures reset correctly, but all respond erratically or not at all to the controller.	The controller is not connected.	<ul style="list-style-type: none"> • Connect controller.
	3-pin/5-pin XLR Out of the controller does not match XLR In of the first fixture on the link (i.e. signal is reversed).	<ul style="list-style-type: none"> • Install a phase reversing cable between the controller and the first fixture on the link.
Fixtures reset correctly, but some respond erratically or not at all to the controller.	Poor data quality.	<ul style="list-style-type: none"> • Check data quality. If much lower than 100 percent, the problem may be a bad data link connection, poor quality or broken cables, missing termination plug, or a defective fixture disturbing the link.
	Bad data link connection.	<ul style="list-style-type: none"> • Inspect connections and cables. Correct poor connections. Repair or replace damaged cables.
	Data link not terminated with 120 Ohm termination plug.	<ul style="list-style-type: none"> • Insert termination plug in output jack of the last fixture on the link.
	Incorrect addressing of the fixtures.	<ul style="list-style-type: none"> • Check address setting.
	One of the fixtures is defective and disturbs data transmission on the link.	<ul style="list-style-type: none"> • Bypass one fixture at a time until normal operation is regained: unplug both connectors and connect them directly together. • Have the defective fixture serviced by a qualified technician.
3-pin XLR Out on the fixtures does not match (pins 2 and 3 reversed).	<ul style="list-style-type: none"> • Install a phase-reversing cable between the fixtures or swap pin 2 and 3 in the fixture, that behaves erratically. 	
No light or LEDs cut out intermittently.	Fixture is too hot.	<ul style="list-style-type: none"> • Allow fixture to cool. • Clean the fan. • Make sure air vents are not blocked. • Turn up the air conditioning.
	LEDs damaged.	<ul style="list-style-type: none"> • Disconnect fixture and return to your dealer.
	The power supply settings do not match local AC voltage and frequency.	<ul style="list-style-type: none"> • Disconnect fixture. Check settings and correct if necessary.

Product Specifications

Model:	Showtec Sunstrip LED
Input voltage:	110–240 V AC, 50/60 Hz
Power consumption:	120 W
DMX linking:	30 pcs
Fuse:	T2AL/250V
Dimensions:	1085 x 146 x 166 mm (LxWxH) (incl. brackets)
Weight:	7 kg
Operating and Programming:	
Signal pin OUT (3-pin):	Pin 1 (earth), pin 2 (-), pin 3 (+)
Signal pin OUT (5-pin):	Pin 1 (earth), pin 2 (-), pin 3 (+), pin 4 (N/C), pin 5 (N/C)
DMX mode:	1, 2, 3, 10, 20 channels
Signal input:	3-pin/5-pin XLR IN
Signal output:	3-pin/5-pin XLR OUT
Electro-mechanical effects:	
Light source:	10 x 14W (Warm/Cool Prolight Opto)
Dimmer:	0–100 %
Strobe:	0–20 Hz
IP rating:	IP20
Control protocol:	DMX-512
DMX control:	via standard DMX controller
Onboard:	OLED display for easy setup
Control:	Auto, Manual, Master/Slave, DMX
Housing:	Die-cast aluminum
Connections:	Pro power connector IN/OUT & data connector
Max. ambient temperature t_a :	40 °C
Max. housing temperature t_B :	70 °C
Minimum distance:	
Minimum distance from flammable surfaces:	0,8 m
Minimum distance to lighted object:	0,8 m

Design and product specifications are subject to change without prior notice.



Website: www.Showtec.info
 Email: service@highlite.com

Dimensions

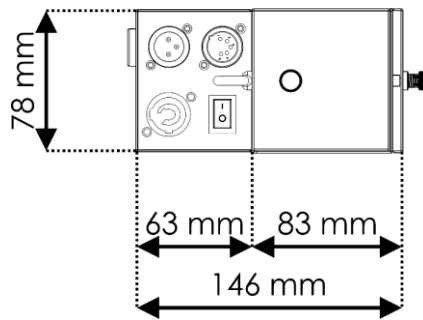
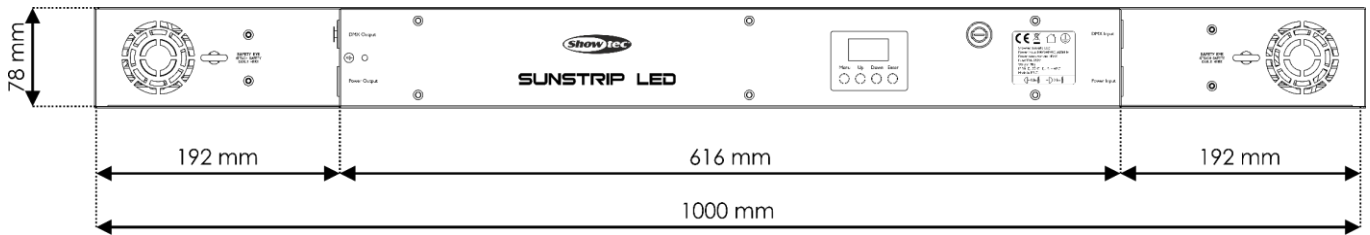
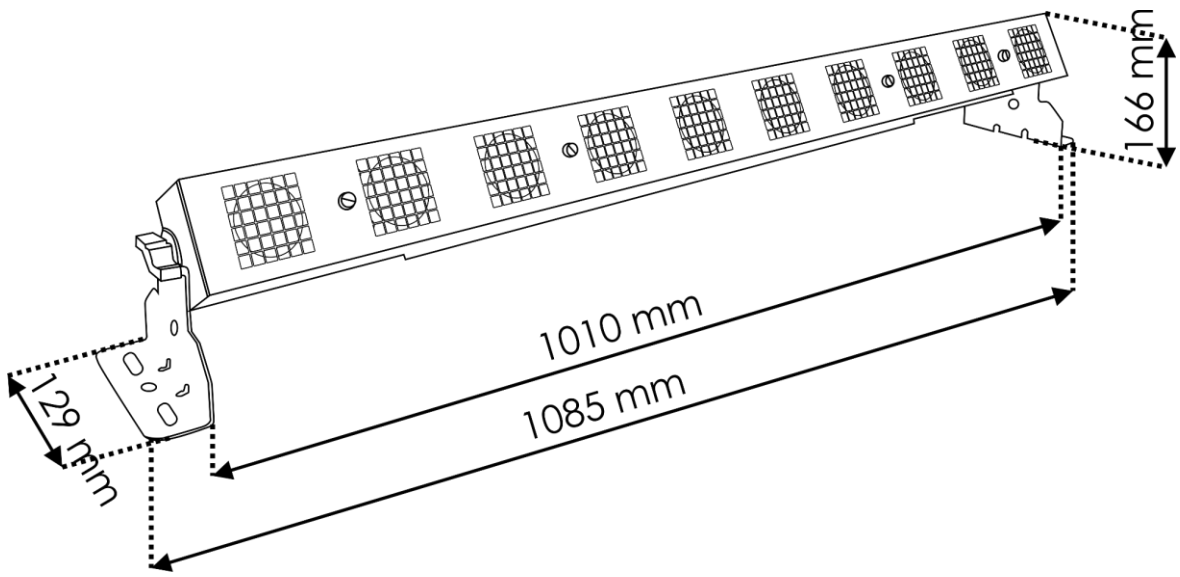



©2019 Showtec